

# STAR WARS<sup>®</sup>

ROLEPLAYING GAME

## ARMS AND EQUIPMENT GUIDE



JEFF GRUBB AND OWEN K.C. STEPHENS

**DESIGNERS**  
JEFF GRUBB, OWEN K.C. STEPHENS

**EDITOR**  
CHARLES RYAN

**MANAGING EDITORS**  
KIM MOHAN, PENNY WILLIAMS

**STAR WARS RPG DESIGN MANAGER**  
CHRISTOPHER PERKINS

**ART DIRECTOR**  
SEAN GLENN

**GRAPHIC DESIGNER**  
ABIGAIL FEIN

**TYPESETTER**  
ANGELIKA LOKOTZ

**COVER ARTIST**  
RALPH MCQUARRIE

**INTERIOR ARTISTS**  
CHRISTOPHER TREVAS, LUCASFILM LTD.

**RPG CATEGORY MANAGER**  
ANTHONY VALTERRA

**PROJECT MANAGER**  
MARTIN DURHAM

**PRODUCTION MANAGER**  
CHAS DELONG

**LUCAS LICENSING EDITOR**  
MICHELLE VUCKOVICH

**LUCAS LICENSING ART EDITOR**  
IAIN MORRIS

Based on the *Star Wars Roleplaying Game* by Bill Slavicsek, Andy Collins, and JD Wiker, utilizing mechanics developed for the new *DUNGEONS & DRAGONS* game by Jonathan Tweet, Monte Cook, Skip Williams, Richard Baker, and Peter Adkison.

This *WIZARDS OF THE COAST* game product contains no Open Game Content. No portion of this work may be reproduced in any form without written permission. To learn more about the Open Gaming License and the d20™ System License, please visit

www.wizards.com/d20.  
620-88664-001-EN

9 8 7 6 5 4 3 2 1 First Printing: October 2002



www.wizards.com

www.starwars.com

©2002 Lucasfilm, Ltd. & ® or ™ where indicated.

All rights reserved. Used under authorization.

DUNGEONS & DRAGONS, WIZARDS OF THE COAST, and the Wizards of the Coast logo are registered trademarks of Wizards of the Coast, Inc., a subsidiary of Hasbro, Inc. The d20 System logo and d20 are trademarks owned by Wizards of the Coast, Inc. Distributed to the hobby, toy, and comic trade in the United States and Canada by regional distributors. Distributed in the United States to the book trade by Holtzbrinck Publishing. Distributed in Canada to the book trade by Fenn Ltd. Distributed worldwide by

Wizards of the Coast, Inc. and regional distributors.

This material is protected under the copyright laws of the United States of America. Any reproduction or unauthorized use of the material or artwork contained herein is prohibited without the express written permission of Wizards of the Coast, Inc. This product is a work of fiction. Any similarity to actual people, organizations, places, or events is purely coincidental.

Made in the U.S.A.

INTRODUCTION .....	3
Using This Book .....	3
Equipment Availability .....	3
Favors, Resource Access, and Availability .....	4
Era .....	4
The Black Market .....	4
<b>CHAPTER 1 WEAPONS • 5</b>	
Customizing and	
Personalizing Weapons .....	5
What Can Be Modified .....	6
Making the Modification .....	6
Concealing Weapons .....	6
Ranged Energy Weapons .....	7
Blaster Pistols .....	7
Heavy Blaster Pistols .....	10
Hold-Out Blasters .....	12
Sporting Blaster Pistols .....	14
Blaster Rifles and Carbines .....	15
Sporting Blaster Rifles .....	18
Light Repeating Blasters .....	19
Ion Guns .....	20
Disruptor Weapons .....	21
Ranged Projectile Weapons .....	21
Slugthrower Pistols .....	22
Slugthrower Rifles .....	23
Dart Pistols .....	24
Flechette Launchers .....	25
Crossbows and Magna Casters .....	26
Wrist Weapons .....	26
Wrist Rocket Ammunition .....	27

Melee Weapons .....	28
Standard Melee Weapons .....	28
Vibro Weapons .....	30
Melee Stun Weapons .....	31
Grenades .....	32
Grenade Launchers .....	34
Other Weapons and Weapon Systems .....	35
Flame Projectors .....	35
Sonic Weapons .....	36
Optional Species Chips .....	37
Species-Specific Ranged Weapons .....	37
Weapon Attachments and Accessories .....	38
<b>CHAPTER 2 PROTECTIVE GEAR • 39</b>	
Customizing and Personalizing Armor .....	39
What Can Be Modified .....	39
Making the Modification .....	40
Other Rules Concerning Armor .....	40
Light Armor and Protective Suits .....	40
Medium Armor .....	42
Heavy Armor .....	43
Powered Armor .....	43
Other Protective Gear .....	45

<b>CHAPTER 3 DROIDS • 46</b>	
Astromech Droids .....	46
Droid Heroes .....	48
Repair Droids .....	50
Protocol and Commercial Droids .....	52
Medical Droids .....	55
Military Droids .....	56
Security and Guard Droids .....	58

Surveillance and Probe Droids .....	60
Messenger Droids .....	61
Labor Droids .....	62
Other Droids .....	65

<b>CHAPTER 4 VEHICLES • 68</b>	
Customizing Vehicles .....	69
What Can Be Modified .....	69
Making the Modification .....	69
Airspeeders and Cloud Cars .....	69
Cloud Jockeys and Speeder Aces .....	69
Gliders, Jetpacks and Rocket Packs .....	71
Speeder Bikes and Swoops .....	72
Civilian Groundspeeders .....	75
Military Groundspeeders .....	79
Walkers .....	81
Seacraft .....	83
Other Vehicles .....	83

<b>CHAPTER 5 EQUIPMENT • 85</b>	
Breathing Devices .....	85
Communication Devices .....	86
Detection Devices .....	89
Sensor Jammers and Detection Countermeasures .....	91
Medical Equipment .....	92
What's in My Medical Kit? .....	92
Security Devices .....	93
Survival Gear .....	95
What's in My Escape Pod? .....	95
Tools and Other Sundries .....	96
What's in My Tool Kit? .....	96



Welcome to the *Star Wars Arms and Equipment Guide*, a compendium of useful and needed items for freelance adventurers, soldiers for hire, and aspiring rebels in the teeming galaxy. The weapons, armor, and other equipment detailed within allow players and Gamemasters (GMs) to give a bit of variety to the standard blaster pistols, armors, and vehicles of the galaxy, and in some cases to give heroes an extra edge in critical or dangerous situations.

The *Arms and Equipment Guide* is an accessory for the *Star Wars Roleplaying Game*. You'll need a copy of that book to use the tools and rules provided in this volume. This sourcebook is useful to both players and GMs, since the devices detailed within can be used by both heroic characters and their allies and opponents.

## Using This Book

What kind of blaster does that bounty hunter carry? What is the best outfit to wear when sneaking through the forests of Endor? How smart is an EV-series droid? Han Solo has modified his blaster—how can I do the same? The *Arms and Equipment Guide* provides a wealth of information on various types of equipment, from the many different varieties of blaster rifles to the wide range of survival tools available to the enterprising hero. Also, optional rules are presented to allow characters to customize and personalize their items, making those weapons and vehicles more effective in a pinch.

This introduction outlines the purpose and function of the book, and also includes information on some of the terminology used within.

Chapter One covers weapons, ranging from the various types of blaster pistols, carbines, and rifles to more esoteric weapons such as sonic weapons and flamers. In addition, rules are included for customizing and personalizing various types of weapons.

Chapter Two discusses armor and rules for customization of armor for particular users.

Chapter Three describes a wide variety of common droids available for use in the galaxy, including astromechs, protocol droids, and other specialized droids.

Chapter Four covers vehicles, including landspeeders, airspeeders, and speeder bikes. Also featured are some light military craft that heroes might get their hands on through various means.

Chapter Five deals with useful tools, including various types of communication, detection, and security gear, medical equipment, and survival tools.

## Equipment Availability

Not all types of equipment, weapons in particular, are readily available to the consumer. Sometimes this lack of availability is due to manufacturing and distribution limitations, sometimes to cultural restrictions, and sometimes to governmental regulation. The availability of an item reflects how common it is to the average hero of the galaxy. In addition to availability, an item may also have legal restrictions placed on its use.

The availability ratings defined below are generalizations, and local variations and regulations apply. In an area under embargo by the Imperial Navy, all equipment, even the most common, is harder to locate. Certain planets or cities may place additional limitations on the use of certain weapons—for example, most weapons (even those rated as prevalent) are restricted on the peaceful world of Alderaan. At the other end of the spectrum, all but the most deadly illegal devices are tolerated on some of the more violent worlds of the Outer Rim.

Every item has an availability rating, and some also have legal restrictions.

**Prevalent:** The item is readily available throughout the galaxy.

**Common:** The item is available in the galaxy's larger commercial centers, including most cities and starports.

**Specialized:** The item is usually restricted to a particular species, planet, or region of space. Within its home area the item is normally prevalent or common. Beyond this area its price may double, if it is available at all.

**Rare:** The item is rare as a result of low production runs, highly specialized demand, or governmental restrictions.

**Licensed:** Ownership of the item is generally legal for anyone, but a permit is required. The permit fee, paid at the time of purchase, is an extra cost, usually 5% of the item's price.

**Military:** The item is usually available only to governmental organizations or to those with ties to them—but private ownership of surplus equipment is not too uncommon. The given price is for a surplus item of serviceable quality.

**Restricted:** Members of the general public cannot legally purchase or own the item; sale or ownership requires governmental license and approval. A restricted item brought into a system may be locked down on its ship, quarantined, or confiscated. Ownership without proper documentation results in minor penalties.

**Illegal:** The item is strictly illegal on most worlds. Illegal items are usually confiscated if discovered. Possession results in severe penalties.



cost might double or triple), or in less than mint condition (a Repair check may be needed to bring it to full operation).

The era codes are:

☉ Available primarily in The Rise of the Empire era. The item may also be available in later eras, but much more rarely, as old surplus.

☽ Available primarily in the Rebellion era.

☾ Available only in The New Jedi Order era or later.

## The Black Market

"Everything is for sale," said one enterprising and open-minded Imperial bureaucrat, "if the price is right." The black market thrives on this ethos, providing otherwise unavailable materials without pesky licenses and permissions (though reasonable facsimiles of documentation are available for a surcharge, usually about 10% of the item's price).

Contacting representatives of the black market and closing the deal can be an adventure in itself. As a rule of thumb, items involved in black market dealings should cost at least triple the normal price. Barter is acceptable within the black market, though the items offered should, again, be worth triple the normal price of the desired item.

Most individuals contact the black market for items that are not normally available through common channels. This may be the result of local government concerns, or perhaps a pangalactic ban on particularly noxious or dangerous items. The Corporate Sector, for example, is notable for its restrictions on luxury items commonly available elsewhere in the galaxy. These restrictions result in a thriving black market and create golden opportunities for smugglers. Other conditions that encourage the black market may crop up where traditional forms of commerce have broken down (during wartime, for example) or in times of local scarcity (during famines and plagues).

The black market, as befits its status, is the domain of crime lords and other colorful individuals who may see themselves as petty rulers of their own domains, or as important linchpins in galactic commerce. Such an individual must be reasoned with, flattered, and paid off to gain the needed equipment. In general, the individual knows he is holding a winning hand, and wrings as much in concessions as he feels the market will bear.

In addition to other challenges in dealing with the black market, delivery may be problematic, and the item may not be in the best possible shape (not to mention the possibility of potential interference of the local government in the transaction). When dealing with the black market, as in all transactions, let the buyer beware.

### Favors, Resource Access, and Availability

Certain classes and prestige classes, such as the crime lord, have special abilities through which they may be able to gain equipment quickly. In general, any item that is not either restricted or illegal can be acquired through the resource access special ability.

Acquiring items of restricted or illegal classification requires calling in a favor. For restricted equipment, the favor check DC is 20, assuming that the appropriate documentation is included, though it may be either accurate or forged. Without documentation, treat restricted equipment as illegal.

For illegal equipment, the favor check DC is 25 or perhaps higher. In some places, a particular illegal item may simply not be available.

## The Eras of Play

The vast majority of the equipment and weapons in this book are available in all three common eras of play. Most of the items had been common features of galactic life for decades—even centuries—before the assault on Naboo.

The era of an item is a brief indication of how common the item is within the various periods of play. An item is not usually available in eras prior to its first appearance (though prototypes are always possible). The same holds true for eras later than those indicated; the item won't be commonly available, but might still be around. It may be harder to find (a common item might become rare), more expensive (the

4

INTRO

11



A good craftsman uses the right tool for the job, and for your average hero, the right tool is the proper weapon. This chapter details the rich variety of weapons available in the galaxy, ranging from variants of common blasters and slugthrowers to specialty weapons that deal new and strange forms of damage.

All these weapons have advantages and disadvantages. Some deliver more damage, others are better at longer ranges, and still others are preferable when you want to bring in an opponent alive. For raw versatility and customization, the best weapons are still basic blaster rifles and pistols, the preferred choice of most individual combatants.

The weapons presented here are broken down into five categories. First are the energy weapons—blaster weapons and those that use similar types of energy. Next are projectile weapons (slugthrowers and dart throwers), followed by thrown grenades and other explosives. Following these are melee weapons, ranging from common swords to vibro weapons, followed by a catch-all category for intriguing weapons that do not fall into any other category, including flamers and sonic weapons. At the end of the chapter is a short section on accessories and attachments for use with some of the weapons.

Each weapon is described by a number of attributes, as follows.

**Weapon Type:** The general type of weapon—slugthrower pistol or blaster rifle, for example.

**Proficiency Group:** The weapon proficiency feat required for use of this weapon. No new feats are introduced here, but sometimes a particular Exotic Weapon Proficiency feat grants proficiency with more than one item. For example, Exotic Weapon Proficiency (flame projector) covers all flamers.

**Cost:** The normal cost of the weapon, in credits.

**Damage:** The normal damage dealt by the weapon.

**Critical:** The threat range for a possible critical hit.

**Range Increment:** The base range of the weapon—the distance out to which an attack carries no penalty for range. Melee weapons have no range increment. Thrown weapons have a maximum range equal to five increments. All other ranged weapons have a maximum range equal to ten increments.

**Weight:** The weapon's weight.

**Fort DC:** Fortitude saving throw DC needed for special forms of attack.

**Type:** The type of damage dealt by the weapon—slashing, energy, or bludgeoning, for example.

**Multifire/Autofire:** M indicates that the weapon can be multifired; A indicates that it can be fired on auto. If neither option is listed, the weapon can only fire one shot per attack.

**Size:** The size of the weapon. This attribute may affect which species can use the weapon, or if the weapon requires one or two hands to wield properly.

**Hardness:** How well the weapon resists damage if it is attacked. See Attack an Object in Chapter Eight of the *Star Wars Roleplaying Game*.

**WP:** The weapon's wound points. See Attack an Object in Chapter Eight of the *Star Wars Roleplaying Game*.

**Break DC:** The DC needed to break the item with a Strength Check.

**Availability:** How available the item is. See Equipment Availability in the introduction for definitions of the various availability ratings.

**Era:** The eras of play in which the item is usually available. See the introduction for more information.

**Special:** Any special rules for this weapon or weapon type.

## Customizing and Personalizing Weapons

A skilled individual can take a store-bought weapon and tinker with it, tuning its galvanizing coils, shaving off weight, and otherwise fiddling with its design to optimize its performance. Such adjustments may improve the weapon considerably, depending on how much time and money the hero wishes to spend on it.

Weapons can be customized or personalized. You can customize a weapon for others. You can personalize a weapon only for yourself.

**Customized Weapons:** A customized weapon has been tinkered with to increase its performance. Any user who picks up the weapon benefits from its improvements.

**Personalized Weapons:** A personalized weapon has been tailored to the specific needs of the owner. This process improves its performance—but only for that individual. For other users, the weapon's normal statistics apply, as if the weapon had not been modified at all. Because personalizing a weapon alters a number of attributes to strike a precise balance for a particular user, you cannot customize some features and personalize others—if any modification is a personalization, they all are.

**Table 1-1: Weapon Modification Limits**

Weapon	Maximum Customized Modifications	Maximum Personalized Modifications	Skill DC to Modify
Blaster pistol	2	3	15
Blaster rifle	1	2	15
Heavy weapons	1	Cannot be personalized	20
Vibro weapons	1	2	10
Slugthrowers	1	2	10
Simple	0	1	5
Simple (grenades)	0	0	—
Exotic	0	1 (with GM's permission)	20

### What Can Be Modified

When you modify a weapon, you can change any of the following attributes. (Some attributes do not apply to certain types of weapons.) You may perform any of these modifications two or more times unless otherwise specified.

- ⊕ Increase the range increment by half the base range increment (rounding down to the closest even number). For example, you could increase the range increment of a blaster rifle from 10 meters to 14 meters.
- ⊕ Increase damage by +1. This modification incurs a -1 penalty on all attack rolls.
- ⊕ Expand the weapon's threat range by 1 (for example, changing the threat range of a blaster pistol from 20 to 19-20). This may be done only once per weapon.
- ⊕ Reduce the weapon's weight by half. This may be done only once per weapon.
- ⊕ Increase the weapon's accuracy, giving it a +1 attack bonus. This modification incurs a -1 penalty on all damage rolls.
- ⊕ Lessen the weapon's multifire penalty by 1. This may be done only once per weapon.
- ⊕ Lessen the weapon's Rapid Shot feat penalty by 1. This may be done only once per weapon.
- ⊕ Increase the weapon's Fortitude save DC by +2.
- ⊕ Make the weapon more durable, increasing its hardness by 2 and its wound points by 2.

### Making the Modification

Success, and the time required to make the modification, are determined as for crafting an item, but either the Repair skill or the appropriate Craft skill may be used. If you have five or more ranks in both the Repair skill and the appropriate Craft skill, the GM may grant a +2 synergy bonus on your skill check. If a tech specialist with the appropriate mastercraft ability is working on the modification, a +2 circumstance bonus applies. If you don't have the proper tools, you take a -5 penalty on the check.

To make the modification, follow these steps.

1. Find the item's price, either from Chapter Seven of the *Star Wars Roleplaying Game*, from this volume, or from the GM. Do not multiply it by 10, as you would for a standard Craft check.
2. Pay one-quarter of the item's price for raw materials.
3. Determine the price of the modified item. A modified weapon's cost is increased by 50% of the weapon's base cost for each modification. For example, a blaster pistol costs 500 credits. A blaster pistol with one modification costs 750 credits, and a blaster pistol with two modifications costs 1,000 credits.
4. Make an appropriate skill check to reflect one day's work, against the DC given on Table 1-1. If the check

succeeds, multiply the check result by your skill modifier (your appropriate skill ranks + your Intelligence modifier + any appropriate miscellaneous modifiers). If that number equals or exceeds the modified item's price, you have completed the modification.

If your check result  $\times$  your skill modifier is lower than the modified item's price, then that number represents progress you have made this day toward completing the modified item. Subtract the amount of progress from the modified item's price and record the new reduced value. At the end of the next day of work, make another check. Each day, you make more progress until the day when your check result  $\times$  your skill modifier equals or exceeds the modified item's remaining value. At that point, you have completed the modification.

Upon completion of the modification, make a final skill check (again, using the DC from the table) to determine if the item functions as intended. If the check fails, the modification does not work and all the time, money, and effort is wasted. If the check fails by 5 or more, the item was broken in the process of modification, and it must be repaired (or jury-rigged) just to bring it back up to its basic functionality.

You may take 10 on skill checks for modifying a weapon. You may not take 20, regardless of the skill you use.

A mastercrafted weapon may be further customized or personalized, working from the base cost of the mastercrafted weapon. A weapon that has been customized may be further customized or personalized, provided that the weapon has not reached its maximum number of customizations (see Table 1-1).

While it is being modified, a weapon is useless, but it can be made operational by jury-rigging. A jury-rigged weapon has all the properties of the weapon before the modification was begun.

Here's an example of modifying a weapon: Vor'en Kurn wants to increase the damage of his weapon, even though it will become more difficult for him to hit his target. The price of a blaster pistol with one modification is 750 credits. The cost of materials for one modification is 125 credits (one-fourth of the weapon's normal cost). The skill check has a DC of 15 (as shown on Table 1-1). Kurn has a Repair skill modifier of +10 and the appropriate tools. By taking 10, he gets a result of 20 on his first day's Repair check. So, at the end of his first day he has made 200 credits' worth of progress (check result of  $20 \times$  skill modifier of +10) toward the modified blaster pistol's price. After taking 10 for three more days, he has exceeded the modified item's price and customized the pistol. He makes another Repair check to see if the modification holds (again, taking 10) and succeeds. His pistol now does +1 damage, but he takes a -1 penalty on attacks with it.

### Concealing Weapons

The galaxy can be a rough-and-tumble place, so many adventurers carry their weapons openly almost everywhere they go. Sometimes, however, an obvious weapon isn't really appropriate—or a hero might want to conceal a backup weapon to supplement the blaster on her hip.

It's assumed that, when attempting to conceal a weapon, a character is wearing appropriate clothing—something moderately loose and bulky. Tighter or skimpier clothes make concealment harder, while larger clothes, such as cloaks or long coats, make it easier.

Drawing a concealed weapon is more difficult than drawing a regularly holstered weapon, and normally requires an attack action. Keeping the weapon in an easier-to-draw position makes concealing it a bit more difficult.

To conceal a weapon, make a Sleight of Hand check. A character concealing a weapon before she heads out into public can usually take 10 unless she's rushed, trying to conceal it when others might see her, or under other unusual constraints. Sleight of Hand can be used untrained in this instance, but the character must take 10.

A weapon's size imposes a modifier on an attempt to conceal it, as shown on the table below. The type of clothing worn by the user, and any attempt to make the weapon easier to draw, can also affect the check. Use all the modifiers that apply from the following table when making the Sleight of Hand check.

**Table 1-2: Concealment Modifiers**

Condition	Sleight of Hand Modifier
Weapon is Tiny	+4
Weapon is Small	+0
Weapon is Medium-size	-4
Weapon is Large	-8
Clothing is tight or skimpy	-4
Clothing is especially loose or bulky	+2
Clothing is specifically modified for concealing weapon	+6
Weapon can be drawn normally	-2
Weapon can be drawn as free action with Quick Draw feat	-4

Noticing a concealed weapon requires a Spot check. The DC varies: If the target made a roll when concealing a weapon, the DC of a Spot check to notice the weapon is the same as her check result (an opposed check, in other words). If the target took 10 on her Sleight of Hand check, use this formula:

Spot DC = Target's Sleight of Hand skill modifier (including modifiers from Table 1-2) + 10

Patting someone down to locate a hidden weapon requires a similar check. However, the skill employed is Search, and the searcher gets a +4 circumstance bonus for the hands-on act of patting the target down.

The size modifiers on the table above apply only to weapons. Weapon size categories do not use the same physical dimensions as size categories for other objects. (A chair, for example, is a Small object, even though it's much bigger than many Large weapons.) When using these rules to conceal objects other than weapons, use the size modifier based on a comparably sized weapon, not on the object's size category.

## Ranged Energy Weapons

Energy weapons are the most common types of ranged weapons in the galaxy, and have been dominant for centuries. They fire bolts of concentrated, coherent light that strike with a concussive impact. In addition, most blasters can be tailored to stun an opponent.

The most common energy weapons are blaster pistols and blaster rifles, which are commonly referred to as blasters.

Within a blaster, a gas with high energy potential is fed into a conversion enabler and excited by energy from a power source (usually a portable, built-in energy cell). The excited gas passes into the actuating blaster module, where it is compressed into a bundle of tightly packed energy particles. This bundle in turn passes through a prismatic crystal to focus it into a beam, which is further concentrated and shaped in the barrel by the galven circuitry. The final beam escapes from the emitter nozzle at the muzzle as a coherent blast of brilliant energy.

Blasters provide a great deal of punch for the investment. They vary from easily concealed hold-out pistols to huge repeating weapons and bunker-mounted cannons.

Ion pistols and ion rifles comprise another type of energy weapon. They are similar in appearance to blasters, but they fire a broad beam of ionizing energy that does not harm sentient beings but wreaks havoc on droids and cybernetic parts.

Disruptors, another type of energy weapon, function similarly to blasters, but instead of firing a blast of concentrated energy, they instead blast waves of broadband energy that break down the bonds between molecules. Extremely deadly, disruptors are illegal throughout the galaxy.



### Blaster Pistols

Blaster pistols are small energy weapons wielded with one hand. They are the most common energy weapons in the galaxy. The blaster pistol is carried by law enforcement agents, galactic merchants, and anyone with a need for basic firepower.

Unless otherwise noted, every blaster pistol uses a rechargeable standard power pack that has enough energy for 100 shots before needing to be replaced. A power pack costs 25 credits and weighs 0.1 kg.

#### BlasTech DH-17

**Weapon Type:** Blaster pistol  
**Proficiency Group:** Blaster pistols  
**Damage:** 3d6-1  
**Range Increment:** 12 m  
**Fort DC:** 15  
**Multifire/Autofire:** M  
**Hardness:** 5 **WP:** 2  
**Availability:** Prevalent, licensed

**Cost:** 550  
**Critical:** 20  
**Weight:** 1 kg  
**Type:** Energy  
**Size:** Small  
**Break DC:** 14  
**Era:**   

A workhorse of a blaster pistol, the long-nosed DH-17 continues to be popular even after the introduction of more advanced models. While later models such as the DL-18 provide more energy in exchange for a shorter range, the DH-17 was the weapon of choice on both sides of the Galactic Civil War. It continues to be a popular weapon with smugglers and independent traders who admire its extended range.

#### BlasTech DH-23 "Outback"

**Weapon Type:** Blaster pistol  
**Proficiency Group:** Blaster pistols  
**Damage:** 3d6  
**Range Increment:** 8 m  
**Fort DC:** 14  
**Multifire/Autofire:** M  
**Hardness:** 5 **WP:** 4  
**Availability:** Prevalent, licensed

**Cost:** 500  
**Critical:** 20  
**Weight:** 1 kg  
**Type:** Energy  
**Size:** Small  
**Break DC:** 17  
**Era:**   

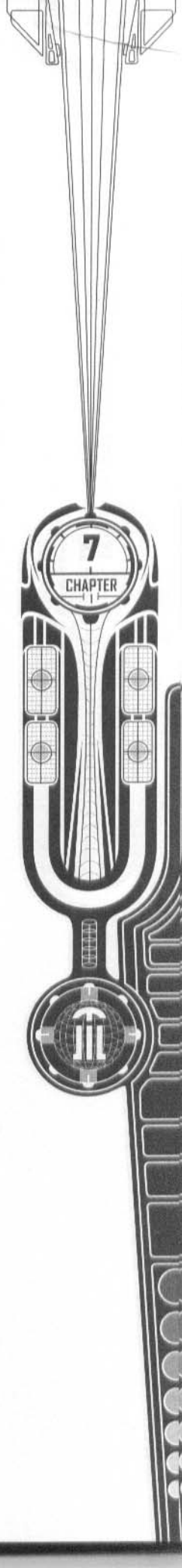

A modification of the DH-17, The DH-23 is built with one principal attribute in mind: durability. Its range and its effectiveness as a stun weapon are inferior to the DH-17, but it has a more effective heat radiator shroud and tight body construction, making the Outback more difficult to break.

#### BlasTech DL-18 Blaster Pistol (Typical Blaster Pistol)

**Weapon Type:** Blaster pistol  
**Proficiency Group:** Blaster pistols  
**Damage:** 3d6  
**Range Increment:** 10 m  
**Fort DC:** 15  
**Multifire/Autofire:** M  
**Hardness:** 5 **WP:** 2  
**Availability:** Prevalent, licensed

**Cost:** 500  
**Critical:** 20  
**Weight:** 1 kg  
**Type:** Energy  
**Size:** Small  
**Break DC:** 15  
**Era:** ☉ ☽ ☾

The DL-18 has served as the galaxy's basic blaster for decades. It was the foundation of many later BlasTech designs as well as the company's fortunes. Versatile enough to balance multiple requirements, the BlasTech DL-18 and its chief competitor, the Merr-Sonn Model 44, are among the most ubiquitous of these weapons. Typical models such as these are often heavily customized by their owners. The DL-18 is also known as the Mos Eisley Special™ since it is a common weapon among the crime lords of that Tatooine city.

#### BlasTech DL-22

**Weapon Type:** Blaster pistol  
**Proficiency Group:** Blaster pistols  
**Damage:** 3d6+1  
**Range Increment:** 10 m  
**Fort DC:** 14  
**Multifire/Autofire:** M  
**Hardness:** 5 **WP:** 2  
**Availability:** Prevalent, licensed

**Cost:** 550  
**Critical:** 20  
**Weight:** 1 kg  
**Type:** Energy  
**Size:** Small  
**Break DC:** 14  
**Era:** ☉ ☽ ☾

BlasTech's response to the Merr-Sonn DD6, the DL-22 uses a higher-grade focusing crystal in the barrel to increase the damage just a fraction at the expense of its stunning ability. Though this extra damage is regarded as a minor benefit for the added cost, the weapon is a good choice for individuals who intend to invest additional time to produce an even harder-hitting weapon through customization.

#### Elmainin Armaments SBP-200 Blaster Pistol

**Weapon Type:** Blaster pistol  
**Proficiency Group:** Blaster pistols  
**Damage:** 2d6  
**Range Increment:** 10 m  
**Fort DC:** 14  
**Multifire/Autofire:** M  
**Hardness:** 3 **WP:** 2  
**Availability:** Prevalent, licensed

**Cost:** 300  
**Critical:** 20  
**Weight:** 1 kg  
**Type:** Energy  
**Size:** Small  
**Break DC:** 13  
**Era:** ☉ ☽ ☾

An attempt by the small Elmainin Armaments group (EA) to undercut the powerful Merr-Sonn and BlasTech companies produced the SBP-200, which proved to be little more than an ineffective knock-off of their most popular models. The weapon is fragile, and its substandard focusing crystals are less effective than those of equivalent blasters produced by the major companies. EA was reduced to selling the bulk of its products in backwater regions such as the Tion Hegemony to customers more eager for a deal than for

quality merchandise. SBPs occasionally show up among private guard units and small militias.

#### Greff-Timms Industrial ATA Pulse-Wave Blaster

**Weapon Type:** Blaster pistol  
**Proficiency Group:** Blaster pistols  
**Damage:** 3d6  
**Range Increment:** 6 m  
**Fort DC:** —  
**Multifire/Autofire:** —  
**Hardness:** 5 **WP:** 2  
**Availability:** Rare, restricted

**Cost:** 600  
**Critical:** 20  
**Weight:** 1 kg  
**Type:** Energy  
**Size:** Small  
**Break DC:** 15  
**Era:** ☉

Pulse-wave weapons are the ancestors of current blaster weapons. They fire packets of coherent energy with devastating effect, but they have poor range and lack the ability of later energy weapons to stun their opponents. By the time of the rise of the Empire, pulse weapons were archaic and Greff-Timms Industrial was a footnote in history; however, this weapon still sees use in the Outer Rim and in Wild Space, particularly on backwater worlds.

#### Imperial Munitions/BlasTech KK-5 Blaster Pistol

**Weapon Type:** Blaster pistol  
**Proficiency Group:** Blaster pistols  
**Damage:** 3d6+1  
**Range Increment:** 12 m  
**Fort DC:** 15  
**Multifire/Autofire:** M  
**Hardness:** 5 **WP:** 2  
**Availability:** Prevalent, licensed  
**Special:** This weapon takes a -1 penalty on attacks.

**Cost:** 600  
**Critical:** 20  
**Weight:** 1 kg  
**Type:** Energy  
**Size:** Small  
**Break DC:** 13  
**Era:** ☽

The KK-5 was produced from designs provided by BlasTech but under the control of the Empire's own manufacturing facilities, known in the galactic bureaucracy as Imperial Munitions. These facilities were usually nationalized factories belonging to smaller manufacturers that the Empire suspected of Rebellion leanings. BlasTech, whose own weapons were increasingly showing up in Rebel hands, was more than willing to show its loyalty by providing technical assistance to the throne.

The resulting weapon was unpromising—though to BlasTech's credit, that wasn't due to poor design. The Empire's initial runs were plagued by defective prismatic crystals in the focusing rings, which seriously impaired the weapon's performance. BlasTech continued to produce its own designs, and while the Imperial Munitions weapon was common in the Core, it did not spread much farther. Manufacturing of the KK-5 was curtailed at the end of the Galactic Civil War.

#### Imperial Munitions/SoroSuub SC-4 Blaster Pistol

**Weapon Type:** Blaster pistol  
**Proficiency Group:** Blaster pistols  
**Damage:** 3d6  
**Range Increment:** 12 m  
**Fort DC:** 15  
**Multifire/Autofire:** M  
**Hardness:** 5 **WP:** 2  
**Availability:** Prevalent, licensed

**Cost:** 500  
**Critical:** 20  
**Weight:** 1 kg  
**Type:** Energy  
**Size:** Small  
**Break DC:** 15  
**Era:** ☽ ☾

**Special:** A tracking device in the grip records when and where this weapon is fired. When in range of the global positioning network, it transmits this information to an Imperial tracking computer.

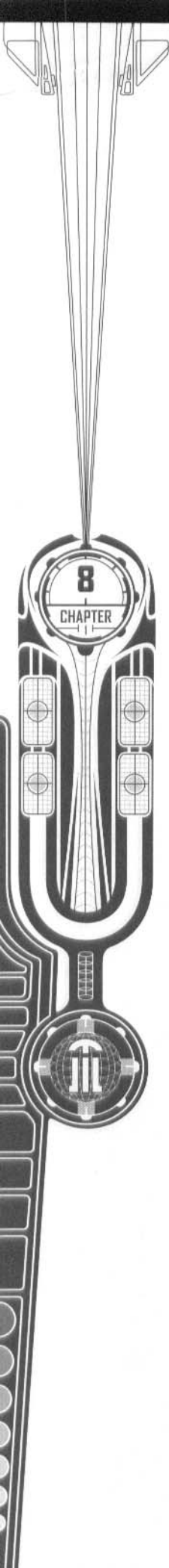





BlasTech DL-18

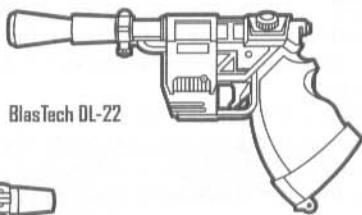

BlasTech DL-22

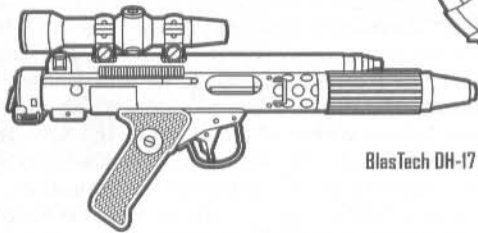

BlasTech DH-17

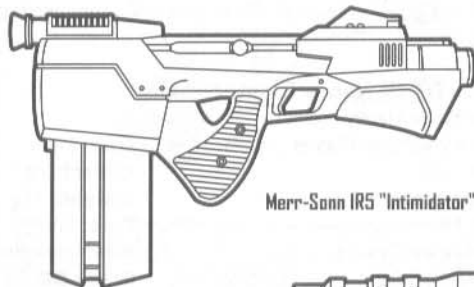

Merr-Sonn IR5 "Intimidator"

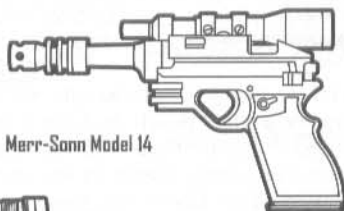

Merr-Sonn Model 14

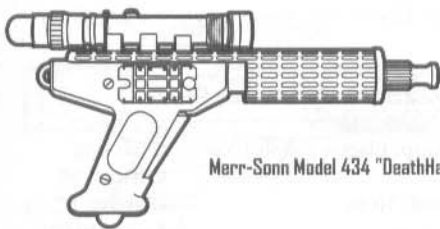

Merr-Sonn Model 434 "DeathHammer"

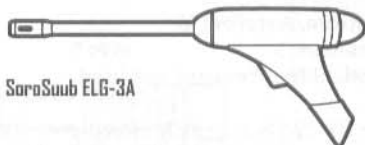

SoroSuub ELG-3A

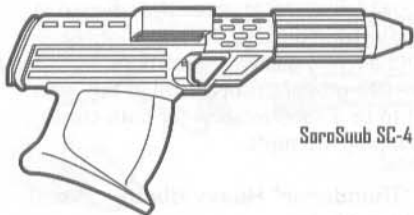

SoroSuub SC-4

A SoroSuub design provided for the Empire in the same manner as the BlasTech KK-5, the SC-4 is a solid, dependable blaster. During the Rebellion era, it was sold in the densely populated core worlds, usually to important citizens who needed extra protection. What these buyers didn't know was that each weapon's grip contained a code traceable by the Empire via a global positioning network. In other words, the Empire could locate a specific SC-4, and its owner, at any time. In addition, some versions were fitted out with microcharge explosives. On a computer-coded signal, such a pistol would explode, dealing 4d6 points of damage to all within 2 meters (Reflex DC 15 half).

The secret of the SC-4 was revealed to the Rebellion when SoroSuub became more active in the Rebel cause. At that point, a large number of these weapons were dumped on the open market, and the Rebels learned how to use captured Imperial computers to track them. Removing the tracker and the microcharge (if present) from a weapon counts as a single modification.

#### Merr-Sonn Model 44

**Weapon Type:** Blaster pistol

**Proficiency Group:** Blaster pistols

**Damage:** 3d6

**Range Increment:** 10 m

**Fort DC:** 15

**Multifire/Autofire:** M

**Hardness:** 5

**WP:** 2

**Availability:** Prevalent, licensed

**Cost:** 500

**Critical:** 20

**Weight:** 1 kg

**Type:** Energy

**Size:** Small

**Break DC:** 14

**Era:**

The Merr-Sonn alternative to the BlasTech DH-17, the Model 44 is similar to the DH-18 in performance if not appearance. Like the DH-18, it is a highly customizable baseline blaster pistol that serves a variety of needs equally well. Merr-Sonn models were once found primarily among Republic and later Imperial Forces, but a large number of them have found their way into the civilian market.

#### Merr-Sonn Model 434 "DeathHammer"

**Weapon Type:** Blaster pistol

**Proficiency Group:** Blaster pistols

**Damage:** 3d6+2

**Range Increment:** 8 m

**Fort DC:** 14

**Multifire/Autofire:** M

**Hardness:** 6

**WP:** 2

**Availability:** Prevalent, licensed

**Cost:** 650

**Critical:** 20

**Weight:** 1.2 kg

**Type:** Energy

**Size:** Small

**Break DC:** 15

**Era:**

The 434 gained its nickname from bounty hunters who appreciated both the weapon's durability and its stopping power. Its durasteel plating provides additional protection but adds to the weapon's weight. DeathHammers are common among bounty hunters and professional killers, who often decorate them ornately, adding more detail and filigree after every kill.

#### Merr-Sonn IR-5 "Intimidator"

**Weapon Type:** Blaster pistol

**Proficiency Group:** Blaster pistols

**Damage:** 2d6

**Range Increment:** 8 m

**Fort DC:** 15

**Multifire/Autofire:** M/A

**Cost:** 750; +200  
for retractable stock

**Critical:** 20

**Weight:** 1 kg

**Type:** Energy

**Size:** Small (Medium-size with stock attached)

**Hardness:** 5      **WP:** 2      **Break DC:** 14

**Availability:** Specialized, licensed      **Era:** Ⓛ

**Special:** Unlike most blaster pistols, the IR-5 may be set to automatic. In this mode, it takes a -4 penalty on attack rolls in addition to any other penalties unless the retractable stock is used.

A radical departure from traditional Merr-Sonn pistol designs, the Intimidator is a bulky, angular weapon—practically a heavy blaster—but it sacrifices range, damage, and accuracy for the benefit of a full automatic setting. Developed during the height of Imperial spending, the weapon proved too pricey to justify its benefits, so most Intimidators were remaindered through a Hutt trading company.

#### SoroSuub ELG-3A "Diplomat's Blaster"

**Weapon Type:** Blaster pistol

**Proficiency Group:** Blaster pistols

**Damage:** 3d6

**Range Increment:** 10 m

**Fort DC:** 17

**Multifire/Autofire:** M

**Hardness:** 4      **WP:** 2

**Availability:** Prevalent, licensed

**Cost:** 500

**Critical:** 20

**Weight:** 0.5 kg

**Type:** Energy

**Size:** Small

**Break DC:** 15

**Era:** Ⓛ Ⓜ Ⓝ

While known for its vehicles, SoroSuub also produces a sleek line of weapons called the ELG series, intended primarily for bodyguards and other political operatives. The Diplomat's Blaster combines the weight of a hold-out blaster with the range of a blaster pistol, and it is commonly used in situations where weapons are permitted but should not be obvious. The ELG-3A's focusing ring is set precisely to deliver better than average stun damage. This feature makes it an ideal weapon for bringing down potential assailants with minimal damage to the surroundings.

#### Heavy Blaster Pistols

The heavy blaster pistol is a class of energy weapon that seeks to combine the utility of the handgun-sized blaster pistol with the punch of a blaster rifle. The resulting weapon is heavier than a standard blaster pistol, and has a shorter range, but it can deal out more damage on average than the lighter pistols.

Heavy blaster pistols are used primarily by law enforcement officers, bodyguards, and criminals. These weapons are restricted on most planets.

Every heavy blaster pistol uses a rechargeable standard power pack that has enough energy for 50 shots before needing to be replaced. A power pack costs 25 credits and weighs 0.1 kilograms.

#### BlasTech DL-44/Merr-Sonn "Flash" 4 Heavy Blaster Pistol (Typical Heavy Blaster Pistol)

**Weapon Type:** Heavy blaster

**Proficiency Group:** Blaster pistols

**Damage:** 3d8

**Range Increment:** 8 m

**Fort DC:** 18

**Multifire/Autofire:** M

**Hardness:** 5      **WP:** 5

**Availability:** Prevalent, restricted

**Cost:** 750

**Critical:** 20

**Weight:** 1.3 kg

**Type:** Energy

**Size:** Medium-size

**Break DC:** 17

**Era:** Ⓛ Ⓜ Ⓝ

The archetypal heavy blaster, the DL-44 is designed with lethal close combat in mind. Its range is shorter than a blaster pistol's, but the damage it can deliver at close range makes up for this shortcoming. Despite the weapon's restricted status on most worlds, this model has sold well for BlasTech, and its success has encouraged other manufacturers to get into the game. The Merr-Sonn Flash 4, for example, is little more than a copycat design, of almost identical appearance to the DL-44. BlasTech also licensed this design to Imperial Munitions for the Empire's heavy blaster.

Both the BlasTech and the Merr-Sonn designs use a "cautionary pulser" grip that sends out a vibration to warn the user when the power pack is down to 5 shots or fewer. The Imperial Munitions design lacks this feature. Often in the heat of battle, this gentle vibration is overlooked, and neither company accepts responsibility for users whose power packs suddenly turn out to be empty.

The most famous wielder of the DL-44 in The New Jedi Order era was Han Solo. As tales of the General's exploits spread, the weapon enjoyed a substantial boost in sales. Truth to be told, Solo's accomplishments were due more to his own capabilities and the specific modifications he made to his DL-44 than to the attributes of the factory version of the weapon.

#### BlasTech DT-12 Heavy Blaster Pistol

**Weapon Type:** Heavy blaster

**Proficiency Group:** Blaster pistols

**Damage:** 3d8+2

**Range Increment:** 6 m

**Fort DC:** 18

**Multifire/Autofire:** M

**Hardness:** 5      **WP:** 5

**Availability:** Prevalent, restricted

**Cost:** 900

**Critical:** 20

**Weight:** 2 kg

**Type:** Energy

**Size:** Medium-size

**Break DC:** 17

**Era:** Ⓛ Ⓜ Ⓝ

The DT-12 sacrifices both weight and long-range accuracy to provide a lethal punch. Its large trigger grip makes it a preferred choice for those who lack hands like those of a Human. The bounty hunter Greedo used a DT-12, a fact that loyal users of the DL-44 (see above) never tire of telling others.

#### BlasTech DY-225 Heavy Blaster Pistol

**Weapon Type:** Heavy blaster

**Proficiency Group:** Blaster pistols

**Damage:** 3d8-2

**Range Increment:** 10 m

**Fort DC:** 20

**Multifire/Autofire:** M

**Hardness:** 5      **WP:** 5

**Availability:** Prevalent, restricted

**Cost:** 900

**Critical:** 20

**Weight:** 1.3 kg

**Type:** Energy

**Size:** Medium-size

**Break DC:** 17

**Era:** Ⓛ Ⓜ Ⓝ

The DY-225 is extremely effective on the stun setting, capable of bringing down powerful opponents. Designed by BlasTech in the hope of improving the image of heavy blaster pistols (and altering galactic regulations regarding the weapons), the DY-225 proved unsuccessful in this area, though it proved to be a solid weapon for both crowd control and kidnapping attempts.

#### BlasTech T-6 "Thunderer" Heavy Blaster Pistol

**Weapon Type:** Heavy blaster

**Proficiency Group:** Blaster pistols

**Cost:** 900

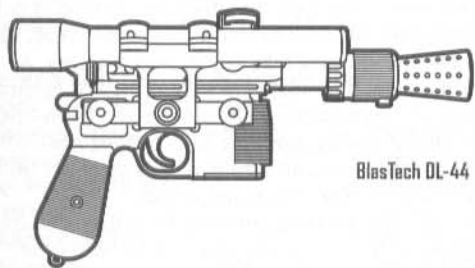

BlasTech DL-44

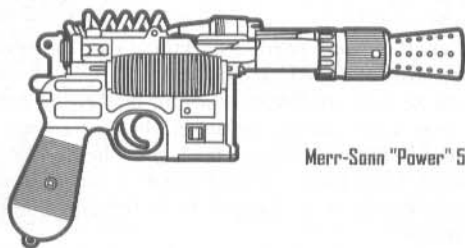

Merr-Sonn "Power" 5

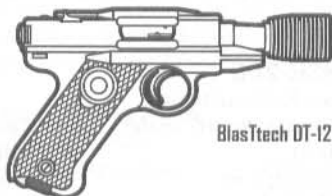

BlasTech DT-12

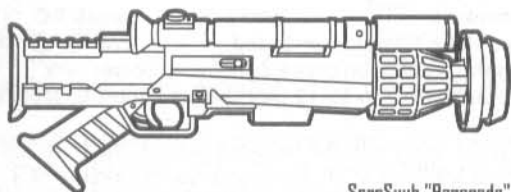

SoroSuub "Renegade"

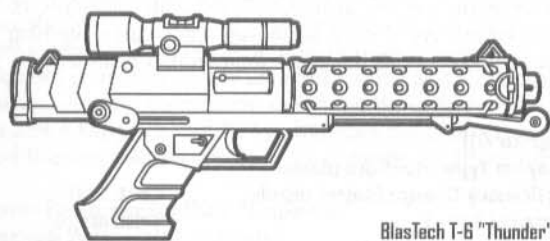

BlasTech T-6 "Thunder"

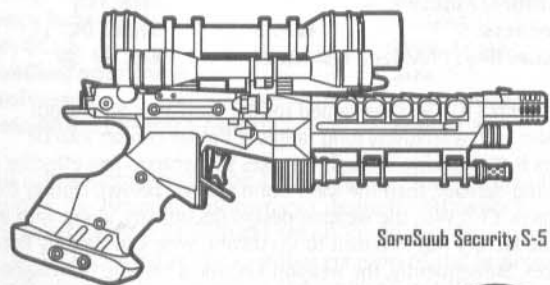

SoroSuub Security S-5

**Damage:** 3d8+3  
**Range Increment:** 8 m  
**Fort DC:** —  
**Multifire/Autofire:** M  
**Hardness:** 5 **WP:** 5  
**Availability:** Common, restricted

**Critical:** 19–20  
**Weight:** 2 kg  
**Type:** Energy  
**Size:** Medium-size  
**Break DC:** 17  
**Era:** Ⓢ

The ultimate "superheavy" blaster pistol, the Thunderer nearly qualifies as a blaster carbine. It has no stun setting, but it deals more damage and scores more critical hits than most other blaster pistols. A flip-down barrel support enables the user to wield the weapon as if it were a small blaster carbine instead of a large hand blaster.

In The New Jedi Order era, the Thunderer is the supreme off-the-shelf blaster pistol. Some systems classify it as a carbine and ban it entirely.

#### Caliban Model X

**Weapon Type:** Heavy blaster  
**Proficiency Group:** Blaster pistols  
**Damage:** 3d8+3  
**Range Increment:** 6 m  
**Fort DC:** 18  
**Multifire/Autofire:** M  
**Hardness:** 4 **WP:** 5  
**Availability:** Prevalent, restricted

**Cost:** 975  
**Critical:** 20  
**Weight:** 1.7 kg  
**Type:** Energy  
**Size:** Medium-size  
**Break DC:** 13  
**Era:** Ⓢ

A "superheavy" blaster pistol from a now-defunct company, the Model X packs a heavy punch but is fragile and requires frequent maintenance. Caliban compounded its difficulties by openly courting Rebels and insurrectionists in its marketing plan, a tactic that brought a quick visit from the Imperial Armed Forces to the company's main headquarters at Calabosh-2. The Caliban factories were absorbed into the nascent Imperial Munitions work, and the design for the weapon was eventually sold to SoroSuub, which used it as a basis for its Renegade model (see below).

#### Merr-Sonn "Power" 5 Heavy Blaster Pistol

**Weapon Type:** Heavy blaster  
**Proficiency Group:** Blaster pistols  
**Damage:** 3d8  
**Range Increment:** 8 m  
**Fort DC:** 18  
**Multifire/Autofire:** M  
**Hardness:** 5 **WP:** 4  
**Availability:** Prevalent, restricted

**Cost:** 825  
**Critical:** 20  
**Weight:** 1.1 kg  
**Type:** Energy  
**Size:** Medium-size  
**Break DC:** 15  
**Era:** Ⓢ Ⓢ Ⓢ

The Power 5 was the first new design of Merr-Sonn in this category, after the Flash 4 showed that the company could compete against the DL-44. Because it is made of lighter weight material than the Flash 4 or the BlasTech DL-44, the Power 5 is a little more fragile than either of those typical heavy blaster models.

#### SoroSuub Model Kylan-3

**Weapon Type:** Heavy blaster  
**Proficiency Group:** Blaster pistols  
**Damage:** 3d8+1  
**Range Increment:** 8 m  
**Fort DC:** 18  
**Multifire/Autofire:** —  
**Hardness:** 6 **WP:** 5  
**Availability:** Prevalent, restricted

**Cost:** 825  
**Critical:** 20  
**Weight:** 1.7 kg  
**Type:** Energy  
**Size:** Medium-size  
**Break DC:** 17  
**Era:** Ⓢ Ⓢ

Following the trend of "superheavy" blasters started by the DT-12, SoroSuub produced a stocky, hard-hitting weapon that was jokingly referred to as a Sullustan Blast Rifle (though Sullustans can wield the weapon one-handed, as can all Medium-size creatures). The Kylan was produced under Imperial contract, but a huge shipment of these weapons was "accidentally" delivered into Rebel hands during the Rebellion.

#### SoroSuub "Renegade" Heavy Blaster

**Weapon Type:** Heavy blaster

**Proficiency Group:** Blaster pistols

**Damage:** 3d8+2

**Range Increment:** 8 m

**Fort DC:** —

**Multifire/Autofire:** M

**Hardness:** 5

**WP:** 5

**Availability:** Common, restricted

**Cost:** 840

**Critical:** 20

**Weight:** 1.3 kg

**Type:** Energy

**Size:** Medium-size

**Break DC:** 17

**Era:** ☉

SoroSuub's last word in blaster design, this weapon was an outgrowth of the Caliban Model X (see above) that solved most of the design problems of that earlier weapon. By eliminating the stun setting from this weapon, SoroSuub managed to keep the force of the bolts high without destabilizing the housing.

The Renegade, as befits its name, has proved to be extremely popular with pirates, smugglers, and others who feel a need to have the largest gun in the room. The SoroSuub model was considered the ultimate in heavy blaster pistol design until it was superseded by the BlasTech T-6 Thunderer (see above).

#### SoroSuub Security S-5 Blaster

**Weapon Type:** Heavy blaster

**Proficiency Group:** Blaster pistols

**Damage:** 3d8-3

**Range Increment:** 8 m

**Fort DC:** 18

**Multifire/Autofire:** —

**Hardness:** 5

**WP:** 5

**Availability:** Prevalent, restricted

**Special:** The weapon has a built-in dart launcher and a grappling spike launcher.

**Cost:** 900

**Critical:** 20

**Weight:** 1.3 kg

**Type:** Energy

**Size:** Medium-size

**Break DC:** 17

**Era:** ☉ ☽ ☿

**Dart Launcher:** *Damage:* 1d4; *Critical:* 20; *Range Increment:* 2 m; *Type:* Piercing, capable of handling special dart ammunition (see the sidebar later in this chapter).

**Grappling Spike Launcher:** See Chapter Seven of the *Star Wars Roleplaying Game*. If used as a ranged weapon, it has the following statistics: *Damage:* 1d8; *Critical:* 20; *Range Increment:* 20 m (also its maximum range); *Type:* Slashing.

The Security S-5 is a combination weapon—it merges the properties of a number of other weapons to produce a piece of equipment that has potential in several areas but excels in none of them. The S-5 is a weak heavy blaster, an acceptable dart thrower, and an adequate grappling gun. What makes it useful is that it can perform all three of these functions, making it a good choice for organizations that may encounter a variety of threats in the course of their work. Elite organizations in generally peaceful locations appreciate the weapon for the choice of response it offers.

## Hold-Out Blasters

Hold-out blasters, some types of which are also called palm blasters, disposable blasters, or throw-aways, are small, easily concealed energy weapons that can fit into a pocket, a satchel, or the folds of a robe with little difficulty. Because of their ease of concealment, hold-out blasters are restricted on many civilized worlds. However, laws against hold-out blasters are typically brought into play only after the possessor has gotten in trouble for greater crimes.

Hold-out blasters are used primarily by individuals who want protection but don't want others to know they are packing energy weapons. Diplomats, nobles, and gamblers often own hold-out blasters. They are also useful in situations where the owner needs a backup in case his primary weapon is lost, damaged, or confiscated.

Because of their small size, hold-out blasters do not use power packs. Unless otherwise noted, they use energy cells, which provide sufficient power for 6 shots before they must be replaced. Some hold-out models have built-in energy cells, requiring the entire weapon to be recharged before it can be reused.

The multifire option is not available with a hold-out blaster pistol.

#### BlasTech HSB-200

**Weapon Type:** Hold-out blaster

**Proficiency Group:** Blaster pistols

**Damage:** 3d4+1

**Range Increment:** 4 m

**Fort DC:** 9

**Multifire/Autofire:** —

**Hardness:** 5

**WP:** 2

**Availability:** Common, restricted

**Special:** This weapon uses a customized power pack (cost 20) that provides energy for 12 shots before it must be replaced.

**Cost:** 360

**Critical:** 20

**Weight:** 1 kg

**Type:** Energy

**Size:** Small

**Break DC:** 14

**Era:** ☉ ☽ ☿

BlasTech's entry into the hold-out market, the HSB-200 is hardly a hold-out at all. Large and clunky because of a design decision to install a cut-down power pack instead of an energy cell, the HSB is practically a small blaster pistol—and an ineffective one at that. Still, it has its adherents, in particular owners of small businesses who want something to scare away toughs but not a weapon that deals lethal damage.

#### Czerka 411

**Weapon Type:** Hold-out blaster

**Proficiency Group:** Blaster pistols

**Damage:** 3d4-1

**Range Increment:** 6 m

**Fort DC:** 10

**Multifire/Autofire:** —

**Hardness:** 5

**WP:** 2

**Availability:** Prevalent, restricted

**Cost:** 300

**Critical:** 20

**Weight:** 0.5 kg

**Type:** Energy

**Size:** Tiny

**Break DC:** 14

**Era:** ☽ ☿

The Czerka 411 was developed for the Empire as a hold-out blaster with a relatively long range. A tighter emitter muzzle gives it that quality, though it makes the weapon less effective at dealing damage than the Merr-Sonn Q2 (see below). During the Galactic Civil War, the weapon design documents, along with an entire factory run in transit to Coruscant, were captured by Rebel forces. Subsequently, the weapon became a favorite of Rebellion espionage agents. The brazen heist, coupled with the then-unproven assertion that Czerka was somehow in cahoots with

the Rebels, prompted the manufacturer to quash the rumors by signing an exclusivity contract with the Empire for its weaponry. This agreement was the foundation of Imperial Munitions.

#### Gee-Tech 12 Defender MicroBlaster

**Weapon Type:** Hold-out blaster  
**Proficiency Group:** Blaster pistols  
**Damage:** 2d4  
**Range Increment:** 4 m  
**Fort DC:** 10  
**Multifire/Autofire:** —  
**Hardness:** 5 **WP:** 2  
**Availability:** Prevalent, restricted  
**Special:** This weapon fires only 2 shots. Its maximum range is two range increments. It grants a +2 circumstance bonus on Sleight of Hand checks made to conceal it.

The designers of the Gee-Tech 12 sacrificed damage and range to create the smallest possible blaster. The weapon is so different from other hold-out blasters that it verges on being an entirely new category of energy weapon. With just enough power for two shots and incapable of hitting anything more than 8 meters away, the MicroBlaster is best used for a surprise attack or as a distraction. It is a disposable weapon that cannot be reloaded.

#### Imperial Munitions Model 22T4

**Weapon Type:** Hold-out blaster  
**Proficiency Group:** Blaster pistols  
**Damage:** 3d4+1  
**Range Increment:** 4 m  
**Fort DC:** 8  
**Multifire/Autofire:** —  
**Hardness:** 5 **WP:** 2  
**Availability:** Specialized, restricted

A tough little weapon with a powerful punch, the 22T4 was made by Imperial-controlled factories using designs provided by Merr-Sonn. Unlike many other such weapons, the 22T4 was subjected to rigorous testing and quality control. The resulting weapon was issued to each member of the Imperial Security Bureau as a personal sidearm (no civilian models were made). Each 22T4 has a serial number contained in a microdot concealed on the underside of the actuating blaster module. Altering the weapon to remove the serial number requires a Repair check (DC 15), but does not count as a modification. Success results in a -1 penalty on attack rolls.

#### Merr-Sonn Model B22 "Imperial"

**Weapon Type:** Hold-out blaster  
**Proficiency Group:** Blaster pistols  
**Damage:** 3d4+1  
**Range Increment:** 4 m  
**Fort DC:** 9  
**Multifire/Autofire:** —  
**Hardness:** 5 **WP:** 2  
**Availability:** Prevalent, restricted

Also called (derogatorily) the Little Emperor, the B22 was the result of the Imperial bureaucracy's desire for an easily concealed weapon its political agents could use. The success of the B22 resulted in the eventual creation of the Imperial Munitions 22T4 (see above) in the Empire's own factories. Following the Galactic Civil War, the B22 was made available

as a consumer model. Its finger-slotted handgrip allows for a fast, accurate draw from a pocket or belt (+2 bonus on Sleight of Hand checks to conceal the weapon).

#### Merr-Sonn Model J1 "Happy Surprise" Palm Blaster

**Weapon Type:** Hold-out blaster  
**Proficiency Group:** Blaster pistols  
**Damage:** 3d4-1  
**Range Increment:** 4 m  
**Fort DC:** 9  
**Multifire/Autofire:** —  
**Hardness:** 5 **WP:** 2  
**Availability:** Common, restricted  
**Special:** This weapon grants a +2 circumstance bonus on Sleight of Hand checks made to conceal it when held in one's hand.

While a traditional hold-out blaster is wielded like a common blaster, held by a grip, the Happy Surprise (a translation of its name in Rodian, *Kheth-saw*) is held entirely in the palm of the hand with its barrel protruding between the second and third fingers. The weapon can be carried in a clenched hand or paw without arousing too many suspicions.

#### Merr-Sonn Model Q2 Hold-Out Blaster (Typical Hold-Out Blaster Pistol)

**Weapon Type:** Hold-out blaster  
**Proficiency Group:** Blaster pistols  
**Damage:** 3d4  
**Range Increment:** 4 m  
**Fort DC:** 10  
**Multifire/Autofire:** —  
**Hardness:** 5 **WP:** 2  
**Availability:** Prevalent, restricted

Just as BlasTech is best known for its DL-44 heavy blaster, Merr-Sonn dominates the hold-out blaster market with the Q2. Lightweight, elegant, and functional, the Merr-Sonn Q2 is an almost expected accessory for the diplomat or noble who is unsure of his or her allies. The Q2 design is so widely favored that SoroSuub licensed the design from Merr-Sonn for its own nearly identical Q-2 model. SoroSuub also used the design as the basis for its heavier ELG line of blasters.

#### Merr-Sonn Model Q4 "Quickfire" Hold-Out Blaster

**Weapon Type:** Hold-out blaster  
**Proficiency Group:** Blaster pistols  
**Damage:** 3d4+2  
**Range Increment:** 2 m  
**Fort DC:** 10  
**Multifire/Autofire:** —  
**Hardness:** 5 **WP:** 2  
**Availability:** Common, restricted  
**Special:** This weapon does not use energy cells. After firing 10 shots, it needs to be recharged by connecting it to any large power source via a special cable (included). Recharging takes 10 minutes.

With this solid, dependable hold-out, Merr-Sonn succeeded where BlasTech's HSB-200 failed in an attempt to build an entire weapon around a power pack. Merr-Sonn's configuration allows both more shots between recharges and more power in each shot. The Quickfire pays for its power with a range that borders on horrible, and it is best used in closed spaces or when the target is not aware that the weapon is present.

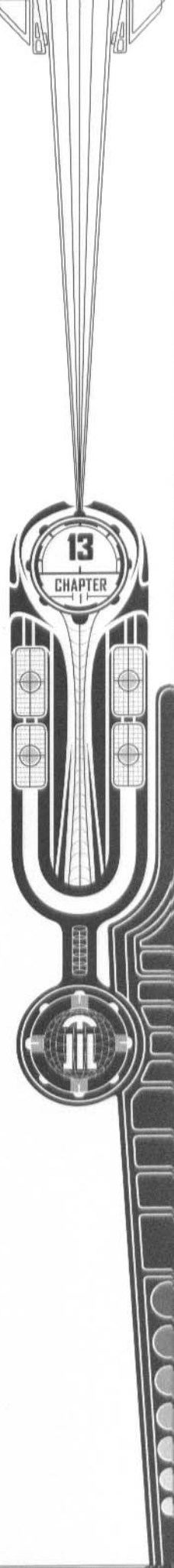

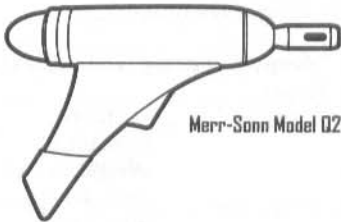

Merr-Sonn Model Q2



Merr-Sonn Model J1 "Happy Surprise"

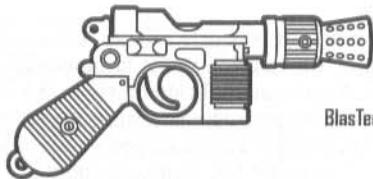

BlasTech HSB-200

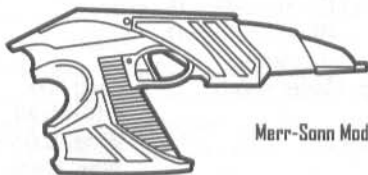

Merr-Sonn Model Q4 "Quickfire"

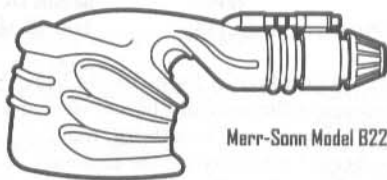

Merr-Sonn Model B22

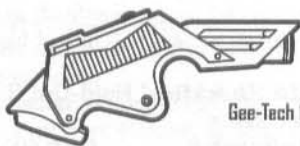

Gee-Tech I2 Defender

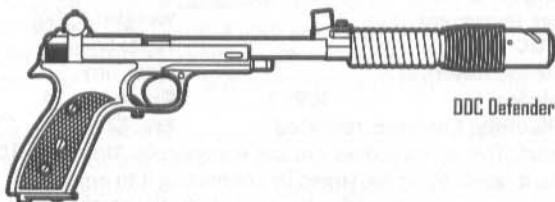

DDC Defender

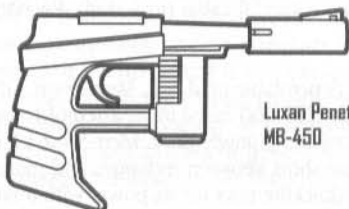

Luxan Penetrator MB-450

## Sporting Blaster Pistols

Also called target blasters, sporting blasters fill the gap between hold-outs and standard blasters. They are common among both nobility and rural inhabitants throughout the galaxy. Sporting blasters tend to be long-barreled and difficult to conceal, but they have a more graceful appearance than the standard blaster. Also, like common blaster pistols, target blasters are free from the regulations that plague most heavy blaster weapons. This lack of regulation is chiefly due to the weapons' lack of firepower.

A sporting blaster uses a standard rechargeable power pack that has enough energy for 100 shots before needing to be replaced. A power pack costs 25 credits and weighs 0.1 kg.

Sporting blaster pistols do not have multifire or autofire capability.

### Drearian Defense Conglomerate Defender (Typical Sporting Blaster Pistol)

**Weapon Type:** Sporting blaster pistol

**Proficiency Group:** Blaster pistols

**Damage:** 3d4

**Range Increment:** 8 m

**Fort DC:** 12

**Multifire/Autofire:** —

**Hardness:** 5

**WP:** 2

**Availability:** Prevalent, licensed

**Cost:** 300

**Critical:** 20

**Weight:** 1 kg

**Type:** Energy

**Size:** Small

**Break DC:** 15

**Era:**

The creation of the designers at the Drearian Defense Conglomerate, the venerable but dependable Defender is often handed down from parent to child. As with all sporting blaster pistols, the Defender has a prominent muzzle and sights, and usually is personalized to provide an ideal shooting weight and aim for its wielder.

As an added benefit, the DDC Defender may be broken down into three parts—grip, body, and barrel. After entering a special three-digit code into a keypad on the weapon, the user can break down the weapon. The various parts can then be hidden and reassembled later. Both disassembly and reassembly require 1 full-round action.

### Luxan Penetrator MB-450

**Weapon Type:** Sporting blaster pistol

**Proficiency Group:** Blaster pistols

**Damage:** 3d4+3

**Range Increment:** 6 m

**Fort DC:** 8

**Multifire/Autofire:** —

**Hardness:** 5

**WP:** 2

**Availability:** Rare, licensed

**Cost:** 550

**Critical:** 20

**Weight:** 1 kg

**Type:** Energy

**Size:** Small

**Break DC:** 13

**Era:**

A powerful target blaster with a negligible stunning attack, the Penetrator from Luxan Personal Armaments, Ltd., is truly a hunting pistol. It uses a double-nested series of precision galven circuits to focus the energy beam, packing a punch that's out of proportion to its size and energy requirements. However, this double-series focusing comes at a cost: The resulting beam is so narrow that its effectiveness against a target is limited. It has a smaller chance to hit its target than do other sporting blasters, but when it hits, it does more damage.

Luxan Personal Armaments is an ancient company serving the elite of the galaxy. Its weapons are hand-crafted and

made to order. They are often customized to the whims of the buyer for an additional cost, but rarely personalized. Each Penetrator is marked to identify its factory origin and manufacturing run. These markings on the casing are usually eradicated or obscured if the weapon has passed through several owners.

#### Merr-Sonn Model 6 "Quick-6"

**Weapon Type:** Sporting blaster pistol

**Proficiency Group:** Blaster pistols

**Damage:** 3d4-1

**Range Increment:** 8 m

**Fort DC:** 14

**Multifire/Autofire:** —

**Hardness:** 4 **WP:** 2

**Availability:** Prevalent, licensed

**Cost:** 360

**Critical:** 20

**Weight:** 0.75 kg

**Type:** Energy

**Size:** Small

**Break DC:** 15

**Era:**   

The Merr-Sonn Quick-6 is a popular target blaster. With its added stun effectiveness, sport hunters find it useful for bringing down live game. Although it is a bit more delicate than competing models, the Quick-6's light weight makes it easy to carry on long journeys through the wild.

#### SoroSuub X-30 "Lancer" Target Blast Pistol

**Weapon Type:** Sporting blaster pistol

**Proficiency Group:** Blaster pistols

**Damage:** 3d4

**Range Increment:** 10 m

**Fort DC:** 10

**Multifire/Autofire:** —

**Hardness:** 5 **WP:** 2

**Availability:** Prevalent, licensed

**Cost:** 330

**Critical:** 20

**Weight:** 1 kg

**Type:** Energy

**Size:** Small

**Break DC:** 14

**Era:**   

A thin-barreled sporting blaster with a balanced stock, the X-30 is SoroSuub's first experiment in overconcentrating the beam to extend the weapon's firepower to a longer range. As a result, the X-30 makes an excellent target blaster for sport hunters as well as a popular backup weapon for assassins. Design elements of the X-30 were later incorporated into SoroSuub's X-45 sniper rifle (see Sporting Blaster Rifles, later in this chapter).

### Blaster Rifles and Carbines

The standard-issue weapon of armed forces throughout the galaxy, the blaster rifle is a long-barreled energy weapon with a heavy stock. It is usually fired with two hands. Primarily military weapons, blaster rifles are produced in such large runs that inevitably many of them find their way into the black and gray markets. Blaster rifles are sought not only by mercenaries and bounty hunters, but also by fringers living on barely tamed planets.

A blaster carbine is a kind of blaster rifle that saves weight with a shorter barrel and a smaller stock. These changes result in a lighter and less cumbersome weapon, at the expense of range and stunning ability.

Both blaster rifles and blaster carbines may be used in multifire mode. Both types of weapon use standard rechargeable power packs that have enough energy for 50 shots. A power pack costs 25 credits and weighs 0.1 kg.

#### Baktoid Armor Workshop E-5 Droid Blaster (Typical Blaster Carbine)

**Weapon Type:** Blaster carbine

**Proficiency Group:** Blaster rifles

**Cost:** 900

**Damage:** 3d8

**Range Increment:** 20 m

**Fort DC:** 15

**Multifire/Autofire:** M

**Hardness:** 4 **WP:** 4

**Availability:** Prevalent, military

**Critical:** 19-20

**Weight:** 2.2 kg

**Type:** Energy

**Size:** Medium-size

**Break DC:** 15

**Era:** 

Lightweight, simply constructed, and cheap, the E-5 was originally a BlasTech design that was reverse-engineered by Baktoid Armor Workshop for use by its droid troopers. The fact that the weapon was intended for use by nonliving wielders allowed BAW to skimp on some of the finer points—such as the fact that short-barreled carbines are comparatively fragile and produce a great deal of heat over repeated firings. While these factors might inconvenience a Human soldier, a Baktoid Battle Drone has no complaints.

With the defeat of the Trade Federation, E-5s were sold as scrap, and many of them fell into the hands of smugglers, space pirates, and other marauders. They are still found throughout the galaxy as late as The New Jedi Order era, as surplus items, but are not as frequently found in the later eras.

#### BlasTech 500 "ESPO" Riot Gun

**Weapon Type:** Blaster rifle

**Proficiency Group:** Blaster rifles

**Damage:** 3d8+1

**Range Increment:** 30 m

**Fort DC:** 16

**Multifire/Autofire:** M/A

**Hardness:** 5 **WP:** 5

**Availability:** Specialized, military

**Special:** This weapon provides a -2 penalty on attack rolls when not in autofire mode.

**Cost:** 1,000

**Critical:** 19-20

**Weight:** 4.5 kg

**Type:** Energy

**Size:** Medium-size

**Break DC:** 17

**Era:**   

A compact, short-barreled blaster rifle with an open-frame stock, the BlasTech 500 was designed for dealing with large crowds. Its design swaps accuracy for the ability to hit something—anything—in its field of fire. Cynics refer to this as "Corporate Sector logic"—when in doubt, shoot into a crowd.

The BlasTech 500 is manufactured exclusively within the Corporate Sector, for use by the Corporate Sector Security Division—better known as the ESPOs. These security officers usually fire their weapons on full automatic, so the limitation of the BlasTech 500 is not as severely felt.

#### BlasTech DLT-20A and A280 Blaster Rifles "Longblasters"

**Weapon Type:** Blaster rifle

**Proficiency Group:** Blaster rifles

**Damage:** 3d8+3

**Critical:** 20 for DLT-20A, 19-20 for A280

**Range Increment:** 30 m

**Fort DC:** 16

**Multifire/Autofire:** M

**Hardness:** 5 **WP:** 8

**Availability:** Prevalent, military

**Era:**    DLT-20A,   A280

**Cost:** 1,300

**Weight:** 6.7 kg

**Type:** Energy

**Size:** Large

**Break DC:** 18

These are two similar models of powerful, oversized blaster rifles often utilized by mounted troops. Many Republic exploratory patrols, and later Imperial garrisons, used local wildlife as mounts, and the Longblaster was ideally suited to

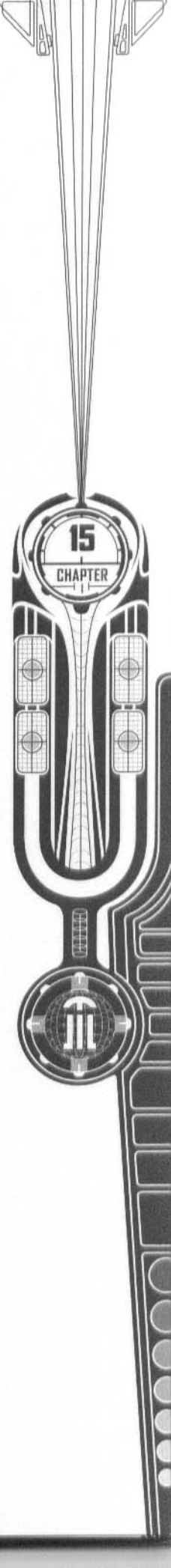

reconnaissance missions where the ability to hit a foe at a great distance was highly valued.

The A280 is based on the initial design of the DLT-20A. An expert can tell that the galven circuits are more bunched near the focusing crystal of the A280, creating a slight bulge at the midsection of the weapon. This change increases the weapon's accuracy and stopping power.

Both models are still in use in The New Jedi Order era, despite their ancient heritage and need for regular maintenance. If well cared for, these rifles will continue to be useful in the future.

### BlasTech E-11/"Freedom One" Blaster Rifle (Typical Blaster Rifle)

**Weapon Type:** Blaster rifle

**Proficiency Group:** Blaster rifles

**Damage:** 3d8

**Range Increment:** 30 m

**Fort DC:** 18

**Multifire/Autofire:** M

**Hardness:** 5

**WP:** 5

**Availability:** Prevalent, military

**Cost:** 1,000

**Critical:** 19–20

**Weight:** 4.5 kg

**Type:** Energy

**Size:** Medium-size

**Break DC:** 17

**Era:** ☉ ☽ ☾

The most identifiable blaster rifle in existence, the compact E-11 looks almost like a carbine at first glance. Its light-weight stock folds up underneath the body of the weapon, and its cooling fins and heat vents reduce the need for a long barrel. A marvel of engineering, the easily produced E-11 is most commonly known as the stormtrooper blaster, though it was used by military forces in the era of the Old Republic as well.

BlasTech's design for the E-11 was licensed to SoroSuub for manufacture. That version was known as the Stormtrooper One and was renamed the Freedom One during SoroSuub's support of the Rebellion. The weapon appears under the latter name in The New Jedi Order era, and it is virtually identical to the E-11.

### BlasTech Firespray DL-87 Stun Rifle

**Weapon Type:** Blaster rifle

**Proficiency Group:** Blaster rifles

**Damage:** 1d8

**Range Increment:** 20 m

**Fort DC:** 15

**Multifire/Autofire:** M

**Hardness:** 5

**WP:** 5

**Availability:** Common, restricted

**Special:** This weapon fires only 10 shots before depleting its power pack. When set on stun, the DL-87 fires stunning energy in a cone-shaped field 6 meters long and 6 meters wide at the far end. Anyone within that area must make a Fortitude save or be knocked unconscious for 1d4+1 rounds. Those who make the saving throw are stunned for 1 round.

**Cost:** 1,000

**Critical:** 20

**Weight:** 4.5 kg

**Type:** Energy

**Size:** Medium-size

**Break DC:** 13

**Era:** ☉ ☽ ☾

An unusual weapon, the DL-87 is not truly a blaster rifle, as its wide, spraylike muzzle clearly attests. The Firespray and its larger cousin the Deck Sweeper (see below) represent a new category of "stun blasters," which are designed to knock out opponents rather than kill them. The Firespray fires two beams of stunning energy from split trapezoids mounted at the corners of the barrel. Its stunning attack affects those caught where the twin beams meet.

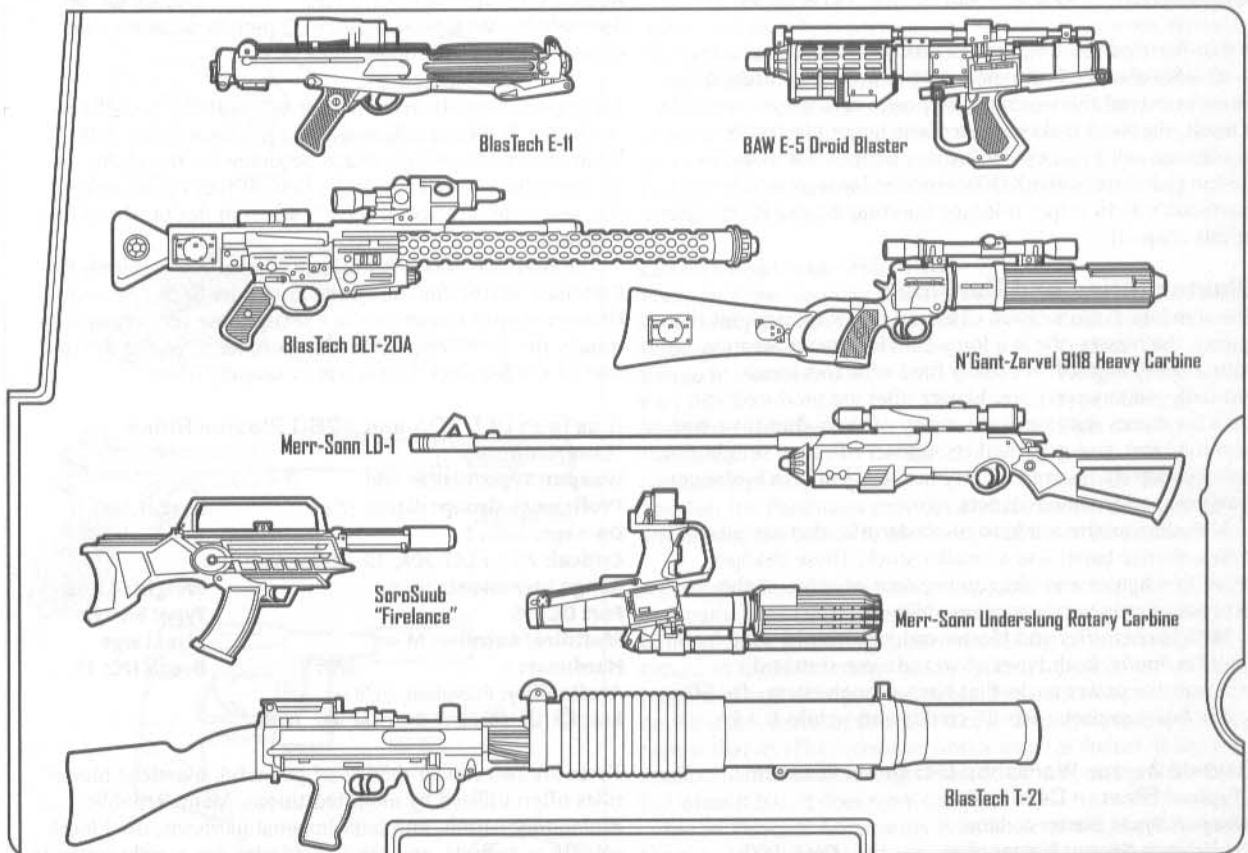



The weapon can be set to deal normal damage, although it has a poor range increment and deals little actual damage. Quirky and easily broken, the Firespray has never caught on.

#### Core World Arms Pulse-Blast Rifle

**Weapon Type:** Blaster rifle

**Proficiency Group:** Blaster rifles

**Damage:** 3d8+2

**Range Increment:** 20 m

**Fort DC:** —

**Multifire/Autofire:** —

**Hardness:** 3

**WP:** 3

**Availability:** Rare, restricted

**Special:** The pulse-blast rifle requires a customized power pack (cost 60, 40 shots per charge). The penalty for range is -3 per range increment instead of the normal -2. This weapon provides a -2 penalty on Move Silently checks when it is loaded and being held or carried.

**Cost:** 2,000

**Critical:** 19-20

**Weight:** 5 kg

**Type:** Energy

**Size:** Medium-size

**Break DC:** 15

**Era:** ☼

This archaic weapon is the great-grandfather of pulse-wave weapons and the modern blaster. Often sought by collectors, it is heavier than the modern blaster rifle and more vulnerable to damage due to its great age. It emits a continual low hum when loaded. Its longer galven chamber produces erratic results at long range, but it is more effective in terms of raw damage than most standard-issue blasters of the day. Rumors swirl that some backwater world far behind on the technology curve continues to produce these weapons in later eras.

#### Greff-Timms Industrial Type A Pulse-Wave Rifle

**Weapon Type:** Blaster rifle

**Proficiency Group:** Blaster rifles

**Damage:** 3d8+3

**Range Increment:** 10 m

**Fort DC:** —

**Multifire/Autofire:** —

**Hardness:** 4

**WP:** 4

**Availability:** Rare, restricted

**Cost:** 1,200

**Critical:** 19-20

**Weight:** 7.7 kg

**Type:** Energy

**Size:** Medium-size

**Break DC:** 15

**Era:** ☼

Little more than a large version of the pulse-wave blaster, the pulse-wave rifle was a museum piece long before the rise of the Empire. While smaller blasters may still be found far from the routes of galactic commerce, pulse-wave rifles often come from raiding the tombs of adventurers of bygone eras, and as such they tend to draw the attention of local governments. The pulse-wave rifle is long and heavy, and its effectiveness drops at ranges longer than a few tens of meters.

#### Imperial Munitions StarAnvil Heavy Blaster Rifle

**Weapon Type:** Blaster Rifle

**Proficiency Group:** Blaster rifles

**Damage:** 3d8

**Range Increment:** 30 m

**Fort DC:** —

**Multifire/Autofire:** —

**Hardness:** 5

**WP:** 10

**Availability:** Rare, military

**Cost:** 2,000

**Critical:** 18-20

**Weight:** 9 kg

**Type:** Energy

**Size:** Large

**Break DC:** 20

**Era:** ☾

This has been called the ultimate blaster rifle. It is a longblaster in the tradition of the BlasTech A280 (see above). It was produced during the Galactic Civil War on the now-desolate factory-moon of Cuthbern. Its designers combined the scope technology of a sporting blaster rifle with the power of a more traditional longblaster to create a nasty, accurate, powerful weapon.

The Cuthbern facility originally produced extremely high-quality runs of E-11s and other weapons licensed from other munitions manufacturers. So high was the quality of the weapons from Cuthbern that the Empire annexed the moon without recompense, enslaved the population, and turned the place into a munitions factory for the Empire. The moon was abandoned after a Rebel attack and remained unoccupied thereafter. Only a small number of StarAnvils were produced. Since then, scattered attempts to retro-engineer the weapon and make new production models have failed.

#### Merr-Sonn Deck Sweeper Stun Blaster

**Weapon Type:** Light repeating blaster

**Proficiency Group:** Blaster rifles

**Damage:** 1d10

**Range Increment:** 15 m

**Fort DC:** 18

**Multifire/Autofire:** —

**Hardness:** 5

**WP:** 10

**Availability:** Common, restricted

**Special:** This weapon fires only 5 shots before its power pack needs to be replaced. When set on stun, this weapon fires stunning energy in a cone-shaped field 8 meters long and 8 meters wide at the far end. Anyone within that area must make a Fortitude save or be knocked unconscious for 1d4+1 rounds. Those who make the saving throw are stunned for 1 round.

**Cost:** 2,000

**Critical:** 20

**Weight:** 4.5 kg

**Type:** Energy

**Size:** Large

**Break DC:** 15

**Era:** ☾

Using the BlasTech Firespray as a base, Merr-Sonn has produced its own stun rifle. Intended primarily as a close-range crowd-control device, the Deck Sweeper has been well received by local police and security forces, though it has been less popular among the organized military bureaucracy. Produced primarily during the Galactic Civil War to handle the threat of "popular rebellions," it remains in the Merr-Sonn catalog, but it is backlisted, and no Deck Sweepers are currently in production. Those that might be available in later eras are of a vintage dating back to the Battle of Endor.

Because all of its advancements were concentrated on its ability to stun, the Deck Sweeper is at best a poor blaster weapon.

#### Merr-Sonn Model G8

**Weapon Type:** Blaster rifle

**Proficiency Group:** Blaster rifles

**Damage:** 3d8

**Range Increment:** 40 m

**Fort DC:** 18

**Multifire/Autofire:** M

**Hardness:** 4

**WP:** 5

**Availability:** Prevalent, military

**Cost:** 1,100

**Critical:** 19-20

**Weight:** 4.5 kg

**Type:** Energy

**Size:** Medium-size

**Break DC:** 15

**Era:** ☼ ☾ ☽

The Merr-Sonn G8 is a standard military blaster rifle, though it is not nearly as prevalent as the E-11. It has the benefit of greater range at the expense of both a higher price and a more fragile housing. During the time of the Old Republic, the Merr-Sonn Model G8 was extremely popular among the frontier expanses, particularly with local authorities in the regions around the Tion Hegemony and Hutt Space. These owners in turn sold the weapons to the nascent Rebel Alliance, making the G8 a common battlefield weapon in the early days of the Galactic Civil War. The Rebels found that a weapon with slightly longer range gave them the drop on stormtroopers in an ambush.

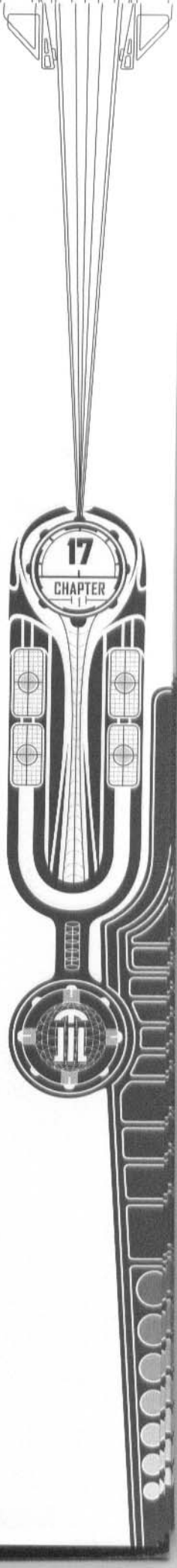

### N'Gant-Zarvel 9118 Heavy Carbine

**Weapon Type:** Blaster carbine  
**Proficiency Group:** Blaster rifles  
**Damage:** 3d8+1  
**Range Increment:** 20 m  
**Fort DC:** 13  
**Multifire/Autofire:** M  
**Hardness:** 6 **WP:** 4  
**Availability:** Common, military

**Cost:** 990  
**Critical:** 19–20  
**Weight:** 2.7 kg  
**Type:** Energy  
**Size:** Medium-size  
**Break DC:** 16  
**Era:** ⚙️

A short-barreled blaster carbine with a heavy stock, the 9118 is an extremely durable weapon suitable for use both in the wild and in urban settings. Produced by a small Rodian operation with distribution through a number of Hutt families, the N'Gant-Zarvel has proved extremely popular with mercenary units and insurrectionists alike. Of particular note is the deep thumping noise this model produces when fired.

### SoroSuub Firelance Blaster Rifle

**Weapon Type:** Blaster rifle  
**Proficiency Group:** Blaster rifles  
**Damage:** 3d8  
**Range Increment:** 30 m  
**Fort DC:** 20  
**Multifire/Autofire:** M  
**Hardness:** 5 **WP:** 5  
**Availability:** Common, restricted  
**Special:** The stun setting for this weapon is effective to a range of 10 meters.

**Cost:** 1,200  
**Critical:** 20  
**Weight:** 2.5 kg  
**Type:** Energy  
**Size:** Medium-size  
**Break DC:** 17  
**Era:** ⚙️ ⚡️ ⚙️

This weapon is a rarity—a blaster rifle with a highly effective stun setting. Sold as “the most effective weapon available for freelance law enforcement officials,” the rifle is primarily intended for use by bounty hunters who have orders to bring their targets back alive. In addition to its stun capability, the Firelance has the benefit of being almost as light as a carbine, making it a good choice for hunters who must track their prey over long distances.

### SoroSuub Heavy Tracker 16

**Weapon Type:** Blaster rifle  
**Proficiency Group:** Blaster rifles  
**Damage:** 3d8+1  
**Range Increment:** 30 m  
**Fort DC:** 18  
**Multifire/Autofire:** M  
**Hardness:** 5 **WP:** 5  
**Availability:** Prevalent, military

**Cost:** 1,100  
**Critical:** 19–20  
**Weight:** 6 kg  
**Type:** Energy  
**Size:** Medium-size  
**Break DC:** 17  
**Era:** ⚙️ ⚡️ ⚙️

The Heavy Tracker—with the emphasis on “heavy”—is a thick-barreled blaster rifle with a built-in stock, otherwise similar to the BlasTech E-11 (see above). The Heavy Tracker, like many SoroSuub weapon designs, was originally licensed from another company (BlasTech in this case). The Sullustan firm produced its own version, fixing what its engineers perceived as flaws in the original. A durable, tough weapon, the Heavy Tracker 16 is good to have on wilderness patrols. It quickly became a favorite of the Rebel Alliance and other insurrectionist movements.

### Sporting Blaster Rifles

Sporting blaster rifles, also called hunting blasters, are lighter, less lethal versions of the standard blaster rifle. They are primarily intended for use on frontier worlds with high wildlife populations, but they are just as commonly used to circumvent legal restrictions against heavier rifles. Sporting blaster rifles are often used by assassins, bounty hunters, and other gun-wielders who prefer this legal nicety.

Every sporting blaster rifle uses a standard rechargeable power pack that has enough energy for 50 shots before needing to be replaced. A power pack costs 25 credits and weighs 0.1 kg.

Sporting blasters cannot be used in multifire or autofire mode.

**Special Rule:** When firing a single shot from a sporting blaster rifle as a full-round action, the user gains a +1 bonus on attack rolls against targets within 80 meters. Sporting blaster rifles have tailor-made sights, and gain no benefit from improved weapon sights (see Weapon Attachments and Accessories, at the end of this chapter).

### Czerka FS-1 Farshot

**Weapon Type:** Sporting blaster rifle  
**Proficiency Group:** Blaster rifles  
**Damage:** 3d6–2  
**Range Increment:** 50 m  
**Fort DC:** 15  
**Multifire/Autofire:** –  
**Hardness:** 5 **WP:** 5  
**Availability:** Prevalent, restricted

**Cost:** 880  
**Critical:** 19–20  
**Weight:** 3 kg  
**Type:** Energy  
**Size:** Medium-size  
**Break DC:** 17  
**Era:** ⚙️ ⚡️ ⚙️

A good frontier weapon, the Farshot sacrifices stopping power for greater range and lighter weight. The weapon is particularly good for farmers and raiders on agricultural and desert worlds, where the ability to hit at a distance may offset the need to do more damage at close range.

### Drearian Defense Conglomerate “Light Sport” (Typical Sporting Blaster Rifle)

**Weapon Type:** Sporting blaster rifle  
**Proficiency Group:** Blaster rifles  
**Damage:** 3d6  
**Range Increment:** 40 m  
**Fort DC:** 15  
**Multifire/Autofire:** –  
**Hardness:** 5 **WP:** 5  
**Availability:** Prevalent, restricted

**Cost:** 800  
**Critical:** 19–20  
**Weight:** 4 kg  
**Type:** Energy  
**Size:** Medium-size  
**Break DC:** 17  
**Era:** ⚙️ ⚡️ ⚙️

Known for its high-quality sporting blaster pistols and rifles, the Drearian Defense Conglomerate is a mid-sized company with a galactic reach. The DDC Light Sport is noted for being a well-balanced, well-tuned target rifle that is equally good when brand-new out of the case or after hanging on the wall for generations. While it lacks the punch of a standard blaster rifle, the Light Sport has a longer range than most of its larger cousins.

### Herloss HBT-4 Hunting Blaster

**Weapon Type:** Sporting blaster rifle  
**Proficiency Group:** Blaster rifles  
**Damage:** 3d6+2  
**Range Increment:** 30 m  
**Fort DC:** 15  
**Multifire/Autofire:** –

**Cost:** 880  
**Critical:** 19–20  
**Weight:** 6 kg  
**Type:** Energy  
**Size:** Medium-size

**Hardness:** 5      **WP:** 5      **Break DC:** 17  
**Availability:** Prevalent, restricted      **Era:** ☉ ☽ ☿

Slightly larger and heavier than most other sporting blasters, the Herloss clearly shows the influence of the DDC Light Sport, upon which it was based. The Herloss model, however, is designed chiefly with the worlds of the Outer Rim in mind, in particular those with large, predatory forms of wildlife. It is particularly favored on planets with excessive vegetation, where its shorter range makes little difference.

#### Merr-Sonn LD-1 Target Blaster Rifle

**Weapon Type:** Sporting blaster rifle  
**Proficiency Group:** Blaster rifles  
**Damage:** 3d6+3  
**Range Increment:** 40 m  
**Fort DC:** 15  
**Multifire/Autofire:** —  
**Hardness:** 4      **WP:** 3  
**Availability:** Prevalent, restricted  
**Special:** The LD-1 can be disassembled to fit into a specially made case. Assembling or disassembling the weapon takes 3 full-round actions.

**Cost:** 1,100  
**Critical:** 19–20  
**Weight:** 4 kg  
**Type:** Energy  
**Size:** Medium-size  
**Break DC:** 13  
**Era:** ☽ ☿

“Sporting” in name only, this rifle is the result of a cynical attempt to make a weapon whose damage approaches that of a blaster rifle without sacrificing the legal protection of a target blaster. The weapon is as fragile as the SoroSuub X-45 (see below), but has more punch per trigger-pull. Like many target/sniper rifles, the Merr-Sonn comes disassembled in a carrying case, and takes 3 full-round actions to assemble and align.

Rumors persist of the existence of an LD-1a, produced in limited runs for the Imperial Security Bureau. This weapon overfocuses the blast beam in the same manner as the SoroSuub X-45. This limited edition has a threat range of 18–20, an availability rating of military/illegal, and a price of whatever the market will bear.

#### SoroSuub X-45 Sniper Rifle

**Weapon Type:** Sporting blaster rifle  
**Proficiency Group:** Blaster rifles  
**Damage:** 3d6+1  
**Range Increment:** 50 m  
**Fort DC:** 13  
**Multifire/Autofire:** —  
**Hardness:** 4      **WP:** 4  
**Availability:** Common, military  
**Special:** This weapon can be disassembled to fit into a specially made case. Assembling or disassembling the weapon takes 2 full-round actions. If this weapon is used to fire only a single shot in a round, its threat range improves to 18–20.

**Cost:** 1,000  
**Critical:** 19–20 (see text)  
**Weight:** 4 kg  
**Type:** Energy  
**Size:** Medium-size  
**Break DC:** 13  
**Era:** ☽ ☿

The SoroSuub corporation attempted to have its cake and eat it too by producing the X-45, a highly accurate sports rifle with an overfocused beam. The focusing produces a blaster bolt thinner than normal, but much more lethal. Originally designed and marketed as a sporting blaster called the Riflette, this weapon was released to the civilian market during the days of the Empire. After it proved to be all too popular with assassins, it was recategorized as military. The X-45 is extremely fragile, and as such it is usually carried in a case until needed.

**Xerrol Nightstinger**  
**Weapon Type:** Sporting blaster rifle  
**Proficiency Group:** Blaster rifles  
**Damage:** 3d6  
**Range Increment:** 40 m  
**Fort DC:** 15  
**Multifire/Autofire:** —  
**Hardness:** 5      **WP:** 5  
**Availability:** Prevalent, restricted  
**Special:** This weapon fires only 5 shots before its special gas canister must be replaced (cost 1,000 per canister). It does not use a power pack.

**Cost:** 1,500  
**Critical:** 19–20  
**Weight:** 4 kg  
**Type:** Energy  
**Size:** Medium-size  
**Break DC:** 14  
**Era:** ☽ ☿

Produced by the Xerrol Corporation for discerning clients (such as the Empire), the Nightstinger has the signature ability to fire an invisible bolt of energy. This ability to strike invisibly is balanced by some extreme drawbacks. The weapon uses customized canisters of specially formulated gas to help create the bolt. These canisters give the Nightstinger a unique look, and they cannot be modified to fit other blasters.

#### Light Repeating Blasters

Light repeating blasters are primarily military weapons, only rarely seen in civilian use. Mercenary units may pick these up for large-scale operations, and Imperial doctrine requires troops wielding these weapons to provide covering fire for the installation of heavier artillery. Light repeating blasters represent the upper end of personal equipment; heavier repeating blasters are primarily the domain of organized military units. A light repeating blaster is usually—though not always—a long, heavy-barreled weapon with an attached tripod support.

A light repeating blaster uses a standard power pack that provides enough energy for 30 shots. Light repeating blasters fire only in multifire or autofire mode.

#### BlasTech T-21 Light Repeating Blaster (Typical Light Repeating Blaster)

**Weapon Type:** Light repeating blaster  
**Proficiency Group:** Blaster rifles  
**Damage:** 3d8  
**Range Increment:** 40 m  
**Type:** Energy  
**Multifire/Autofire:** M/A only  
**Hardness:** 5      **WP:** 10  
**Availability:** Prevalent, military  
**Special:** Autofire puts this weapon under severe stress. In each subsequent round of continuous autofire after the first, roll 1d20 and add +1 to the die roll for each additional round after the first. A result of 10 or higher means the weapon becomes inoperative for 1d6 rounds.

**Cost:** 2,000  
**Critical:** 19–20  
**Weight:** 4.5 kg  
**Size:** Large  
**Break DC:** 20  
**Era:** ☽ ☿

The archetypical light repeating blaster, this weapon is identifiable by its two sets of focusing coils, one next to the targeting sensor and one at the muzzle itself.

The T-21 uses a standard power pack, which has enough energy for 30 shots. It may also be plugged into a separate power source, giving it effectively unlimited ammunition (at the expense of mobility).

The weapon is susceptible to the extreme heat of autofire. Internal cooling units keep the downtime to a minimum, but the weapon is not made for long-term firefights.

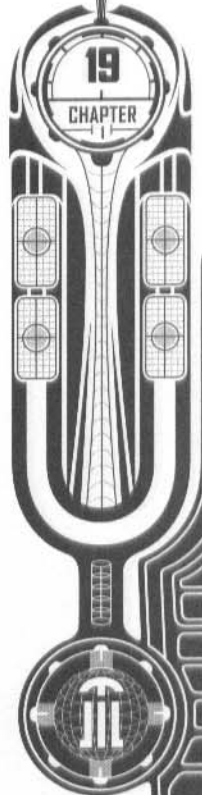

### Merr-Sonn Underslung Rotary Blaster Carbine

**Weapon Type:** Light repeating blaster

**Proficiency Group:** Blaster rifles

**Damage:** 3d8+3

**Range Increment:** 30 m

**Fort DC:** —

**Multifire/Autofire:** M/A only

**Hardness:** 5 **WP:** 10

**Availability:** Common, military

**Cost:** 2,400

**Critical:** 19–20

**Weight:** 2.3 kg

**Type:** Energy

**Size:** Large

**Break DC:** 18

**Era:** ☉

An intriguing design by Merr-Sonn from the Old Republic era that has since been overtaken by the more cost-effective BlasTech T-21 (see above), the Underslung Rotary has two interesting features. First, it is a true rotary weapon, in that a series of timed galven coils must rotate into firing position. In this fashion the Merr-Sonn avoids the overheating problems that plague the later BlasTech design. Second, the weapon is held in an underhand grip and shot from the hip, since aiming accuracy was judged not as important as a steady stream of fire. Both of these concepts were revolutionary for the time, and primarily for that reason the weapon was ignored by both the Old Republic and the rising Empire. The Underslung Rotary went out of fashion, though collectors still seek it out.

### Ion Guns

Ion guns are primarily antidroid weapons. A hit from an ion gun disrupts the actuator pathways within a droid, sending the equivalent of the “halt” function through the restraining bolt. When the weapon is set on full, this effect creates massive damage in the pathways and may destroy the droid. When the weapon is set on stun, it causes the droid to become inactive for 1d4 rounds, similar to unconsciousness in a sentient being. While inactive, a droid is unaware of its surroundings (though hardwired recording devices separate from the droid’s control systems may still operate).

Ion guns do not have any effect on living beings (except, perhaps, when used as impromptu clubs). They do not have any effect on vehicles, except those that utilize droid mechanisms and actuators (walkers and droid-operated cabs, for example). They do not affect other electronic technology, such as electronic locks or tools, computers, or other devices lacking actuator pathways.

Ion guns do affect cybernetic devices, which contain droid-like actuator pathways. A cyborged individual takes damage from an ion gun, and, if stunned, loses the use of cybernetic limbs or body parts for 1d4 rounds. This loss of functionality may lead to blindness, paralysis, loss of mental function, or death, depending on the individual’s degree of cyborgization.

The more powerful ion cannons that are mounted on ships can affect electronic devices, such as starship systems, but they use a different attack matrix than ion pistols and rifles do, and they drain much more power.

Ion guns cannot be used in multifire or autofire mode. Unless otherwise noted, every ion gun uses a standard power pack, which has enough energy for 30 shots.

### Felebreck Electrical Defense Systems Droid Disabler

**Weapon Type:** Ion pistol

**Proficiency Group:** Blaster pistols

**Damage:** 3d6+2

**Range Increment:** 4 m

**Fort DC:** 17

**Multifire/Autofire:** —

**Cost:** 250

**Critical:** 20

**Weight:** 2.2 kg

**Type:** Energy

**Size:** Small

**Hardness:** 5

**WP:** 2

**Break DC:** 14

**Availability:** Common, licensed

**Era:** ☉

**Special:** Damage affects droids and cybernetic systems only. This weapon fires only 5 shots before its power pack needs to be replaced.

A relative latecomer to the field of antidroid weaponry, the Felebreck Droid Disabler was developed in a period of rising malicious droid activity—a time when stories of assassin droids circulated widely, and when pure rogue droids, having lost their programming matrices, became havoc-wreaking wildbots. The Droid Disabler is Felebreck’s attempt to cash in on those concerns, and the company has done a booming business in urban areas that have seen domestic upheaval, foreign invasion, and a rising population of masterless automatons. The Droid Disabler packs a great deal of power for a close-range weapon and is designed primarily to terminate—not just deactivate—dangerous droids.

### Homemade Ion Pistol

**Weapon Type:** Ion pistol

**Proficiency Group:** Blaster pistols

**Damage:** 3d6–1

**Range Increment:** 10 m

**Fort DC:** 20

**Multifire/Autofire:** —

**Hardness:** 3

**WP:** 2

**Availability:** Common, licensed

**Special:** Damage affects droids and cybernetic systems only.

**Cost:** 300

**Critical:** 20

**Weight:** 2.7 kg

**Type:** Energy

**Size:** Small

**Break DC:** 12

**Era:** ☉ ☽ ☿

Ion pistols are relatively easy to manufacture from scrap droid parts and blasters, and technologically enterprising species such as the Jawas and the Squibs are good at putting together effective antidroid weapons that they utilize in their “discovery” and capture of rogue droids. These devices are often held together with bantha spit and wire, but they do the job of incapacitating recalcitrant droids.

### Merr-Sonn DEMP Ion Carbine (Typical Ion Rifle)

**Weapon Type:** Ion rifle

**Proficiency Group:** Blaster rifles

**Damage:** 3d8

**Range Increment:** 30 m

**Fort DC:** 18

**Multifire/Autofire:** —

**Hardness:** 5

**WP:** 5

**Availability:** Common, licensed

**Special:** Damage affects droids and cybernetic systems only.

**Cost:** 800

**Critical:** 19–20

**Weight:** 3.1 kg

**Type:** Energy

**Size:** Medium-size

**Break DC:** 18

**Era:** ☉ ☽ ☿

### Merr-Sonn DEMP Ion Pistol (Typical Ion Pistol)

**Weapon Type:** Ion pistol

**Proficiency Group:** Blaster pistols

**Damage:** 3d6

**Range Increment:** 8 m

**Fort DC:** 15

**Multifire/Autofire:** —

**Hardness:** 5

**WP:** 2

**Availability:** Common, licensed

**Special:** Damage affects droids and cybernetic systems only.

**Cost:** 250

**Critical:** 20

**Weight:** 1 kg

**Type:** Energy

**Size:** Small

**Break DC:** 14

**Era:** ☉ ☽ ☿

In the years since the Trade Federation’s droid-led attack on Naboo, Merr-Sonn has led the way in producing antidroid technology. The company’s Destructive Electromagnetic Pulse (DEMP) guns resemble traditional blaster rifles and

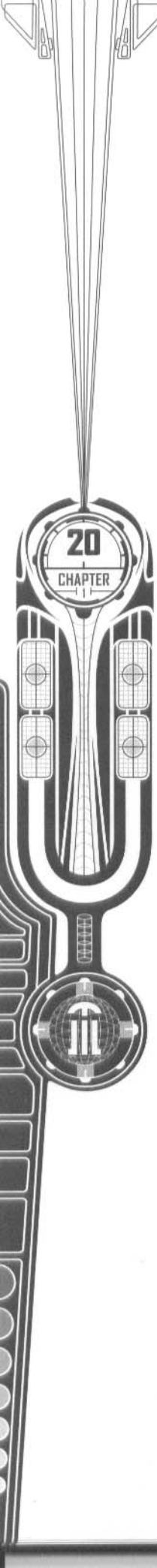

pistols with an oversized discharge cylinder glued to the front, giving a DEMP gun an innocuous, almost comic appearance. Droids, however, take the weapons very seriously, and the sight of a DEMP gun is a sure way to trigger the “pleading and whining” subroutine of a protocol droid.

The availability of DEMP weapons, and most antidroid technology, ebbs and flows with the threat that droids seem to pose. In areas and eras where the threat is extensive, they are popular weapons. When the majority of droids are merely astromechs and servants operating under restraining bolts, DEMP guns are packed away in planetary armories and generally forgotten.

### Disruptor Weapons

A typical blaster’s energy bolt is a packet of concentrated energy that delivers a concussive force when it strikes. A disruptor wave, on the other hand, is a series of nonharmonic vibrations that excite the molecules of the target, causing them to lose cohesion and come apart. Where a blaster bolt leaves a dead body, a disruptor leaves a pile of smoking ash.

Basically, disruptors are disintegrators. They are effective against solid targets, vaporizing starship hulls and armor with equal ease. Individuals struck by disruptor bolts are often completely reduced to ash by a single hit.

Disruptors cannot be used in multifire or autofire mode and cannot be set to stun. They may be fired a maximum of once per round. A typical disruptor rifle gets 10 shots from a power pack, while a disruptor pistol gets 5 shots.

Disruptor weapons are universally reviled, and on the vast majority of worlds the mere possession of one merits the death penalty.

**Special:** All disruptor weapons have extremely slow recycle rates between shots. A disruptor weapon may only be fired once per round, regardless of the number of attacks its wielder is entitled to. A target hit by a disruptor beam must make a Reflex save (DC 10) to avoid a critical hit. A target reduced to 0 wound points by a disruptor is disintegrated.

#### Merr-Sonn Model MSD-32 Disruptor Pistol

**Weapon Type:** Disruptor pistol

**Proficiency Group:** Blaster pistols

**Damage:** 2d10

**Range Increment:** 2 m

**Fort DC:** —

**Multifire/Autofire:** —

**Hardness:** 5 **WP:** 2

**Availability:** Rare, illegal

**Special:** The maximum range of this weapon is four range increments, instead of the normal ten.

**Cost:** 4,000

**Critical:** Special

**Weight:** 3.1 kg

**Type:** Energy

**Size:** Small

**Break DC:** 12

**Era:** ⬇️

This weapon was so deadly and unpopular that evidence of its existence was officially stricken from the Merr-Sonn corporate history. The MSD-32 was commissioned by the Imperial bureaucracy in extremely limited numbers for use by its agents. Many of these weapons quickly fell into the wrong hands, and the ISB (Imperial Security Bureau) spent a great deal of time tracking them down—time that would have been better spent fighting the Rebel Alliance. Ultimately, the design for the MSD-32 was purged from all company computers, the designers were sent to the spice mines, the managers were shot, and the remaining inventory was destroyed.

Despite these draconian tactics, a few MSD-32s have survived. The design has proved to be a very effective

advance over the Tenloss disruptors (see below). Merr-Sonn has managed to coax out better range than the Tenloss pistol, while packing in the deadliness of the Tenloss rifle. The designers achieved this with a phased array of energy pulses (as opposed to an overwhelming blast) that works against the natural harmonics in the molecules of the target. Sought by collectors and assassins alike, a crate of MSD-32s is reported to be still floating around somewhere in the Corporate Sector.

#### Tenloss DX-2 (Typical Disruptor Pistol)

**Weapon Type:** Disruptor pistol

**Proficiency Group:** Blaster pistols

**Damage:** 2d8

**Range Increment:** 2 m

**Fort DC:** —

**Multifire/Autofire:** —

**Hardness:** 5 **WP:** 2

**Availability:** Rare, illegal

**Special:** The maximum range of this weapon is 3 range increments, instead of the normal 10.

**Cost:** 2,250

**Critical:** Special

**Weight:** 2.5 kg

**Type:** Energy

**Size:** Small

**Break DC:** 12

**Era:** ⬆️ ⬇️ ⬇️

#### Tenloss DXR-6 Disruptor (Typical Disruptor Rifle)

**Weapon Type:** Disruptor rifle

**Proficiency Group:** Blaster rifles

**Damage:** 2d10

**Range Increment:** 2 m

**Fort DC:** —

**Multifire/Autofire:** —

**Hardness:** 5 **WP:** 5

**Availability:** Rare, illegal

**Cost:** 3,500

**Critical:** Special

**Weight:** 3.5 kg

**Type:** Energy

**Size:** Medium-size

**Break DC:** 14

**Era:** ⬆️ ⬇️ ⬇️

The Tenloss syndicate is a powerful criminal organization that specializes in contraband goods. It is the only known (admitted) manufacturer of disruptor weapons. Because of this, over the course of time its factories have been assaulted and destroyed not only by the New Republic, but also by the Old Republic, the Empire, the Trade Federation, the Hutts, the Corporate Sector Authority, and several bands of freebooters and space pirates. As a result, Tenloss has essentially gone underground: Its disruptor pistols are handmade to order, and the individuals ordering them are thoroughly investigated before any deal is made.

The pistol and the rifle share an attractive, swept-back design that belies their ugly purpose. They have almost no range to speak of, so they are usually used in surprise situations or in very close quarters. Possession of a Tenloss disruptor is a capital offense on a thousand worlds. For a time, the crime lord Jurga the Hutt wore one on his sash as a symbol of his power. He was eventually disintegrated with it by an irate employee.

## Ranged Projectile Weapons

Unlike energy weapons, projectile weapons fire solid objects—usually metallic slugs, arrows, quarrels, or darts. Projectile weapons are generally less effective than blasters, dealing less damage on average than an energy weapon of similar size. In addition, they tend to leave evidence of their use, such as expended ammunition, that may be tracked back to the original weapon.

Projectile weapons do have a number of basic advantages, however. They tend to be less loud and explosive than blaster weapons, so surreptitious attacks are more feasible. Even a slugthrower may have its noise silenced and its barrel-

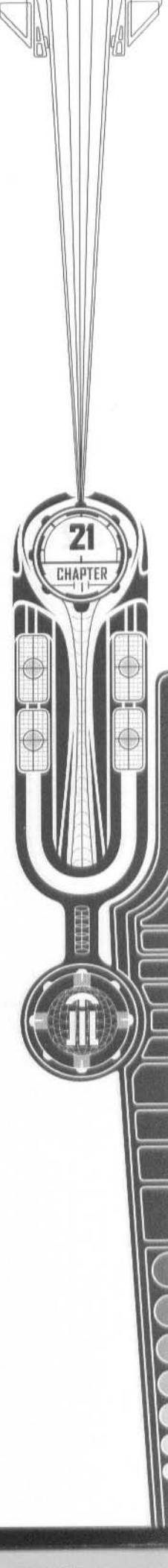

flash suppressed by means of attachments. Unlike blasters, projectile weapons may be loaded with special ammunition that produces effects other than raw damage (see the Special Slugthrower Ammunition sidebar), and they do not require power packs. Finally, projectile weapons tend to be both more durable and more easily repaired than their blaster equivalents.

Projectile weapons are most common in less civilized parts of the galaxy. Legally they are usually treated as blaster weapons of a similar type. Some individual projectile weapons have multifire or autofire capability, but not all do. Projectile weapons do not have stun settings, though they may be loaded with special ammunition that can incapacitate an opponent.

### Slugthrower Pistols

The projectile weapon equivalent of the blaster pistol, a slugthrower pistol depends on the rapid expansion of gas to propel a metal bullet through the barrel. Slugthrower pistols tend to be popular on outpost worlds where the capability to repair blasters is limited. Slugthrower pistols are generally small, and range from hold-outs to the equivalent of heavy blaster pistols. Hold-outs and some special projectile pistols lack multifire capability.

Slugthrowers cannot be set on stun.

#### Czerka Adjudicator

**Weapon Type:** Slugthrower pistol

**Proficiency Group:** Slugthrowers

**Damage:** 2d6-3

**Range Increment:** 10 m

**Fort DC:** —

**Multifire/Autofire:** —

**Hardness:** 4

**WP:** 3

**Availability:** Prevalent, licensed

**Special:** This weapon fires 4 shots before needing to be reloaded. It is reloaded by hand with standard slugthrower ammunition (cost 5 per 50 shots). It takes 1 full-round action to reload.

**Cost:** 325

**Critical:** 20

**Weight:** 0.5 kg

**Type:** Piercing

**Size:** Tiny

**Break DC:** 14

**Era:**   

One of the few slugthrower hold-outs in regular use, the Czerka shares with its blaster pistol relatives a small size that allows it to be concealed up a sleeve or in a pocket without attracting undue attention. It is not a weapon for a firefight, since its limited capacity and slow reload time make the user a sitting duck relatively quickly.

#### Field Sports Air Pistol

**Weapon Type:** Slugthrower pistol

**Proficiency Group:** Slugthrowers

**Damage:** 2d6

**Range Increment:** 4 m

**Fort DC:** —

**Multifire/Autofire:** —

**Hardness:** 5

**WP:** 2

**Availability:** Prevalent

**Special:** This weapon fires 20 shots before reloading. It requires a 20-shot clip of special ammo (cost 10).

**Cost:** 200

**Critical:** 20

**Weight:** 0.8 kg

**Type:** Piercing

**Size:** Small

**Break DC:** 16

**Era:**   

A small, lightweight slugthrower with the same general appearance as a sporting blaster pistol, this air pistol uses a blast of released gas (instead of a chemical explosion) as a propellant. Readily available, it is rarely confiscated because it looks like a toy. It is available in black and shades of gray as well as a rainbow of colors.



### SPECIAL SLUGTHROWER AMMUNITION

Unless otherwise noted, most slugthrowers use a type of slug or bullet, usually a jacketed shell, to deal damage. Some of these weapons, such as the Dissuader and the Blaster Buster, are specifically designed for particular payloads and as such might not use traditional ammo.

For most slugthrowers, special types of ammunition are available at higher prices (though sometimes these types of ammo are restricted). Bounty hunters who use slugthrowers tend to make extensive use of special ammunition in their work. Some mix rounds in the same clip, starting with mercy bullets, then working their way up to pyros and explosives in case the less deadly slugs fail to stop their opponents.

Here are a few special ammunition types.

**Explosive Ammunition:** The target must make a Reflex save (DC 15) or take 1d8 points of additional damage from the explosive charge. Cost is 10 × the cost of standard ammunition. *Availability:* Common, restricted.

**Mercy Ammunition:** These are soft gel bullets intended to stun an opponent. Damage is reduced by half, but the target must make a Fortitude save (DC 15) or be knocked unconscious for 1d4+1 rounds. Individuals in heavy armor or powered armor do not need to make Fortitude saves and cannot be knocked unconscious by mercy rounds. Cost is 5 × the cost of standard ammunition. *Availability:* Common.

**Pyro Ammunition:** The target must make a Reflex save (DC 15) or take 1d6 points of additional fire damage and risk catching on fire (see Chapter Twelve of the *Star Wars Roleplaying Game*). Cost is 5 × the cost of standard ammunition. *Availability:* Common, restricted. ☼

#### Kelvarek Consolidated Arms Dissuader KD-30

**Weapon Type:** Slugthrower pistol

**Proficiency Group:** Slugthrowers

**Damage:** 1d10/special

**Range Increment:** 10 m

**Fort DC:** —

**Multifire/Autofire:** —

**Hardness:** 5

**WP:** 3

**Availability:** Common, licensed

**Special:** This weapon may fire 10 shots before reloading. It requires a 10-shot clip of special ammunition (cost 100). This weapon makes a ranged touch attack to hit.

**Cost:** 350

**Critical:** 20

**Weight:** 1.4 kg

**Type:** Piercing

**Size:** Small

**Break DC:** 16

**Era:**   

A highly advanced and specialized slugthrower, the Dissuader fires special ammunition that consists of a metal-jacketed cartridge filled with borless acid. The shot deals 1d10 points of damage initially; the potent acid then deals 1d4 points of damage per round for 3 rounds or until it is washed off.

The acid destroys armor. Each point of damage reduced by the armor permanently reduces the armor's damage reduction. For example, if the acid deals 3 points of damage to a suit of medium battle armor (DR 5), the armor's damage reduction is reduced to DR 2.

#### Oriolanis Defense Systems Blaster Buster

**Weapon Type:** Slugthrower pistol

**Proficiency Group:** Slugthrowers

**Damage:** 2d6

**Cost:** 700

**Critical:** 20

**Range Increment:** 10 m

**Fort DC:** —

**Multifire/Autofire:** —

**Hardness:** 4 **WP:** 3

**Availability:** Common, licensed

**Special:** This weapon may fire 4 shots before needing to be reloaded. It is reloaded by hand with standard slugthrower ammunition (cost 5 per 50 shots) or special ammunition (cost 10 per 10 shots) that works only with this weapon. It takes a full-round action to reload. When firing its special ammunition, this weapon gains a +4 circumstance bonus on attack rolls against a blaster that has fired within the last round. Damage against the weapon in this situation is doubled.

An advanced slugthrower with a highly specialized niche, the ODS Blaster Buster utilizes a unique, specially made payload. It may be used as a standard slugthrower, but it gains its best benefits as an antiblaster weapon by utilizing special ammunition that works only with this weapon. Using laser-guided targeting along with a heat-seeking payload, the special Blaster Buster shell homes in on a recently fired weapon instead of the individual who fired it. The Blaster Buster has been used by corporate security forces seeking to disarm assailants instead of killing them.

#### **Oriolanis Defense System Striker Projectile Pistol (Typical Slugthrower Pistol)**

**Weapon Type:** Slugthrower pistol

**Proficiency Group:** Slugthrowers

**Damage:** 2d6

**Range Increment:** 10 m

**Fort DC:** —

**Multifire/Autofire:** M

**Hardness:** 5 **WP:** 3

**Availability:** Prevalent, licensed

**Special:** This weapon fires 8 shots before needing to be reloaded. It uses an 8-shot clip of ammunition (cost 5).

The ODS Striker Pistol is a good example of a standard short-range pistol manufactured by a modern company. The Striker Pistol is durable if unimpressive, and it utilizes a standard ammunition clip. The weapon is popular among the worlds of the Outer Rim, but it may be purchased anywhere with ease.

#### **Morellian Weapons Conglomerate Enforcer Pistol**

**Weapon Type:** Slugthrower pistol

**Proficiency Group:** Slugthrowers

**Damage:** 2d6+4

**Range Increment:** 10 m

**Fort DC:** —

**Multifire/Autofire:** M

**Hardness:** 5 **WP:** 3

**Availability:** Rare, restricted

**Special:** This weapon fires 8 shots before needing to be reloaded. It uses an 8-shot clip of ammunition (cost 5). Each shot after the first one fired in a given round takes a cumulative -1 penalty on the attack roll.

The projectile equivalent of the heavy blaster pistol, the Enforcer is produced in limited quantities by the Morellian Weapons Conglomerate for use by its corporate security force. Larger than a standard slugthrower, the Enforcer has a nasty recoil, which makes shots fired in rapid succession erratic.

**Weight:** 1.4 kg

**Type:** Piercing

**Size:** Small

**Break DC:** 14

**Era:** ⚙️ ⚡️ ⚙️

#### **Yctor Arms Black Powder Pistol**

**Weapon Type:** Slugthrower pistol

**Proficiency Group:** Slugthrowers

**Damage:** 2d6-2

**Range Increment:** 4 m

**Fort DC:** —

**Multifire/Autofire:** —

**Hardness:** 5 **WP:** 3

**Availability:** Rare

**Special:** This weapon must be reloaded after each shot. Reloading is a full-round action. Ammunition costs 5 credits per 50 shots.

**Cost:** 200

**Critical:** 20

**Weight:** 1.4 kg

**Type:** Piercing

**Size:** Small

**Break DC:** 16

**Era:** ⚙️ ⚡️ ⚙️

Yctor Arms specializes in collector's items and functional museum reproductions. The black powder pistol is an example from a bygone age; most planets do not even have regulations covering the use of such a weapon. An ornate, long-barreled handgun with a decorated grip (often with an inlay of semiprecious stones), the black powder pistol is slow to reload and relatively ineffective in a modern combat situation.

#### **Slugthrower Rifles**

Slugthrower rifles share many benefits and problems with slugthrower pistols. They are popular both on low-tech worlds as well as with bounty hunters whose travels take them to such far-flung locations.

Slugthrower rifles are often sold as "sport" or "target" weapons, allowing the owners to skate along the edge of planetary restrictions against their energy-based cousins.

Slugthrower rifles may use multifire but not autofire mode. They cannot be set on stun.

#### **Czerka Adventurer**

**Weapon Type:** Slugthrower rifle

**Proficiency Group:** Slugthrowers

**Damage:** 2d8+1

**Range Increment:** 30 m

**Fort DC:** —

**Multifire/Autofire:** M

**Hardness:** 4 **WP:** 5

**Availability:** Prevalent, licensed

**Special:** This weapon may fire 15 shots before needing to be reloaded. It uses a 15-shot clip of ammunition (cost 6).

**Cost:** 360

**Critical:** 20

**Weight:** 4 kg

**Type:** Piercing

**Size:** Medium-size

**Break DC:** 16

**Era:** ⚙️ ⚡️ ⚙️

A long-barreled projectile rifle with excellent aim over long distances, the Czerka Adventurer is used by bounty hunters such as Aurra Sing, since its presence does not trip as many weapon detectors as a large blaster would. The Adventurer floods its chamber with a rich oxidizer as it detonates its shell, giving the projectile both added punch and extra range. In addition, the weapon breaks down easily for off-planet transportation. It takes only a partial action to fit the barrel back to the stock.

#### **Dresselian Projectile Rifle (Typical Slugthrower Rifle)**

**Weapon Type:** Slugthrower rifle

**Proficiency Group:** Slugthrowers

**Damage:** 2d8

**Range Increment:** 20 m

**Fort DC:** —

**Multifire/Autofire:** M

**Hardness:** 5 **WP:** 5

**Availability:** Prevalent, licensed

**Special:** This weapon may fire 12 shots before needing to be reloaded. It uses a 12-shot clip of ammunition (cost 5).

**Cost:** 300

**Critical:** 20

**Weight:** 4 kg

**Type:** Piercing

**Size:** Medium-size

**Break DC:** 18

**Era:** ⚙️ ⚡️ ⚙️

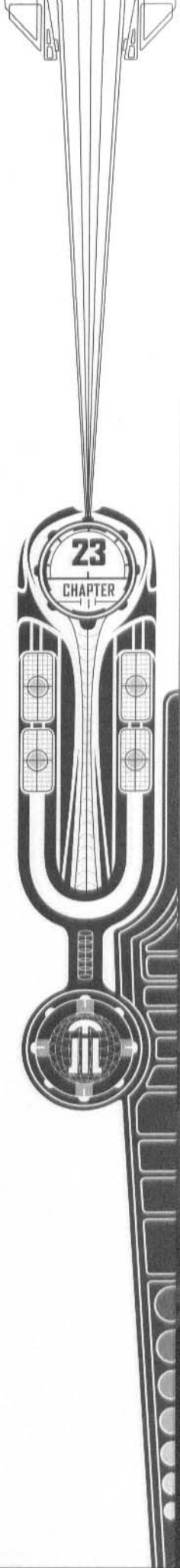

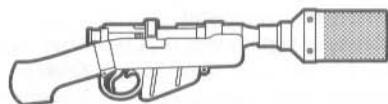

Merr-Sonn Model DEMP Ion Carbine

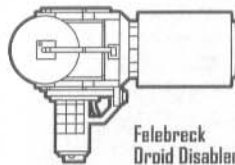
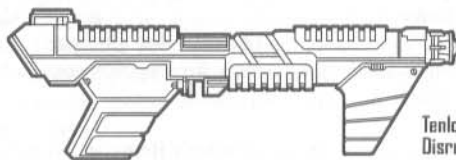
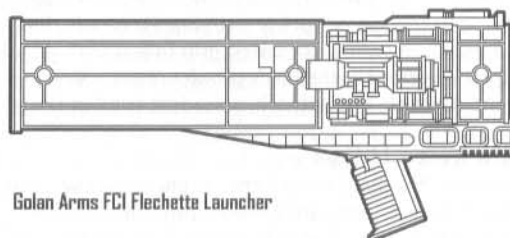
Felebreck  
Droid DisablerPrax Arms  
Protector PRP-502Tenloss DXR-6  
DisruptorKalvarek  
Consolidated  
Arms Dissuader  
KD-30

Golan Arms FCI Flechette Launcher

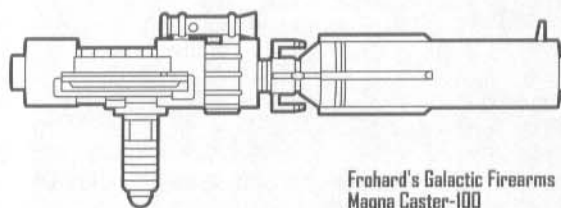
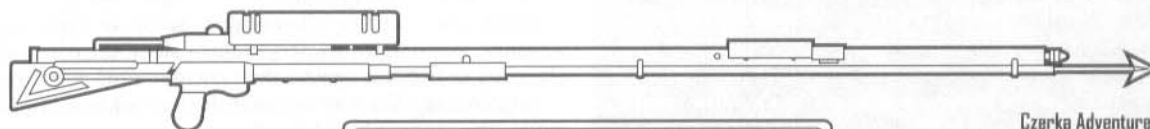
Frohard's Galactic Firearms  
Magna Caster-100

Czerka Adventurer

An excellent example of a slugthrower rifle produced by a low-technology society, the Dresselian Projectile Rifle helped the Dresselians drive off Imperial occupying forces. The Dresselians produced some of the weapons, but others were manufactured by Bothans and smuggled to the planet to aid in the rebellion.

Made of native woods and easily smelted metals, the Dresselian rifle is typical of a projectile weapon built by a native species. It is equivalent to the weapon used by the Tusken Raiders of Tatooine to take potshots at Podracers.

### Dart Pistols

Some projectile weapons use darts instead of metal slugs. Fired from spring-loaded launchers, these small and aerodynamic projectiles tend to have incredibly short ranges and deal little damage by themselves. As a result, dart pistols are often loaded with special ammunition (see the Special Dart Ammunition sidebar). Standard dart ammunition for the two models described here costs 5 credits for 10 shots.

Although it's not a weapon to bring to a firefight, a dart pistol rivals the hold-out blaster for dominance of the concealable weapon niche. Most dart pistols may be broken down into smaller components, which may then be further disguised to prevent discovery. As a result, dart pistols are favored by secret agents and assassins.

Most dart pistols are not illegal. However, some of the more esoteric payloads they carry may be tightly regulated, so care must be taken in their purchase and transportation.

Dart pistols cannot be used in multifire or autofire mode, and they cannot be set to stun.

### Prax Arms Protector PRP-502 Hold-Out Shooter

**Weapon Type:** Dart shooter

**Proficiency Group:** Slugthrowers

**Damage:** 1d4

**Range Increment:** 4 m

**Fort DC:** —

**Multifire/Autofire:** —

**Hardness:** 4

**WP:** 2

**Availability:** Common

**Special:** This weapon fires 4 shots before needing to be reloaded. It takes a full-round action to reload. The weapon can be taken apart or reassembled as 1 full-round action.

**Cost:** 300

**Critical:** 20

**Weight:** 0.5 kg

**Type:** Piercing

**Size:** Tiny

**Break DC:** 12

**Era:**

Prax Arms has found its niche in the manufacture of dart weapons, and produces two of the most common of the type. The Protector PRP-502 looks like a standard hold-out blaster, and may be concealed in the hand in the same manner. In addition, it can be broken down into four components, which are easily hidden and reassembled.

### Prax Arms Stealth-2VX Palm Shooter

**Weapon Type:** Dart shooter

**Proficiency Group:** Slugthrowers

**Damage:** 1d4-1

**Range Increment:** 2 m

**Fort DC:** —

**Multifire/Autofire:** —

**Hardness:** 4

**WP:** 2

**Availability:** Common

**Special:** This weapon grants a +4 circumstance bonus on Sleight of Hand checks made to conceal it when held in one's hand. It fires 3 shots before needing to be reloaded as a full-round action.

**Cost:** 360

**Critical:** 20

**Weight:** 0.5 kg

**Type:** Piercing

**Size:** Tiny

**Break DC:** 12

**Era:**





## SPECIAL DART AMMUNITION

Standard dart ammunition consists of hollow- or solid-tipped darts, made of plastic, metal, or ceramics, about 5 centimeters long. A dart's damage is incidental, even on a critical hit, but the hollow-tipped version is often loaded with additional material to increase its lethality. The dart's tip is sealed to protect the user from contact with the payload, but the seal shatters when the dart strikes a target.

Typical payloads include the following.

**Toxin:** Malkite Themfar and Fex-M3 nerve toxins are both deadly poisons. When used in dart ammunition, they are injury poisons (Fort DC 15), initial damage 2d6 Con and secondary damage 1d6 Con. Other types of poison may be used as well. The dart must deal wound damage in order for the toxin to take effect. The cost is 100 credits per shot. *Availability:* Rare, illegal.

**Knock-Out:** A concentrated dose of the painkiller Symoxin is a common knock-out dart poison. It is an injury poison (Fort DC 18), initial damage 1d6 Dex and secondary damage unconsciousness. Other knock-out drugs may be used as well. The dart must deal wound damage in order for the knock-out drug to take effect. The cost is 10 credits per shot. *Availability:* Common, restricted.

**Acid:** While not as powerful as a slugthrower shell, a borless acid dart deals 1d4 points of damage each round for 3 rounds or until the acid is washed off. (See the Dissuader, earlier in this chapter, for more information about the acid.) A ranged touch attack is used when firing an acid dart. The cost is 10 credits per shot. *Availability:* Common, restricted.

**Tracer:** Instead of dealing damage, the dart contains a small tracking device that functions as a tracer link. With proper tracking technology, the device may be located with a successful Search check (DC 12). A ranged touch attack is used when firing a tracer dart. The cost is 20 credits per shot. *Availability:* Common, military. ☺

The Stealth-2VX is the dart pistol version of the Merr-Sonn Happy Surprise palm blaster (see Hold-Out Blasters, earlier in this chapter). The body of the weapon rests inside one's cupped palm, while the three darts jut from between the fingers.

The Stealth itself weighs only 0.25 kilograms. Its listed weight includes a wristband that comes with the weapon, which is used to store up to six additional darts.

### Flechette Launchers

A flechette launcher fires a canister filled with razor-sharp needles. The canister explodes at a predetermined distance from the user (usually right in front of the target), filling the area with flying spikes for massive damage. A deadly weapon with high collateral damage, the flechette launcher is banned on many worlds and highly restricted on others, usually available only to local military operations.

A flechette launcher cannot be fired more than once per round, and it is usually programmed before it is fired (this may be done in the round it is fired as a move action). The weapon may be fired without programming; its damage is halved in this case. Unlike with grenades, the user cannot target an unoccupied location—the programming must be able to sense a physical target to function properly. The target may make a Reflex save (DC 15) for half damage.

Misses are treated as grenadelike weapons for purposes of determining where they land (see Chapter Eight of the *Star Wars Roleplaying Game*), except that they do not explode if they land in an unoccupied space.

Using a flechette launcher effectively requires the Exotic Weapon Proficiency (flechette launchers) feat. This feat allows the user to fire any flechette launcher.

Flechette launchers cannot be used in multifire or autofire mode, and they cannot be set to stun.

### Golan Arms FC11 Flechette Launcher

**Weapon Type:** Flechette launcher

**Proficiency Group:** Exotic  
(flechette launchers)

**Cost:** 2,000

**Damage:** 3d8 (antipersonnel);  
6d8 (antivehicle)

**Critical:** 20

**Range Increment:** 20 m (4 m)

**Weight:** 20 kg

(antipersonnel); 20 m (2 m) (antivehicle)

**Fort DC:** —

**Multifire/Autofire:** —

**Type:** Slashing

**Size:** Large

**Hardness:** 5

**WP:** 10

**Break DC:** 15

**Availability:** Common, illegal

**Era:** ☺ ☹

**Special:** This weapon fires 6 shots before needing to be reloaded. It is reloaded with flechette canisters (cost 200 per antipersonnel canister or 300 per antivehicle canister). It takes 1 full-round action to reload.

The FC11 is a barely portable, shoulder-fired weapon that expels canisters of razor-sharp microdarts. Each canister explodes at a predetermined distance from a selected target for maximum effect. The weapon can fire both antipersonnel canisters and antivehicle canisters, and has four barrels. An antipersonnel canister has a larger burst radius but does less damage than an antivehicle canister, which is more lethal but affects a smaller area. Both antipersonnel and antivehicle canisters may be loaded in a weapon at the same time, and used as the need arises.

Golan Arms is not known for its innovative designs, and the FC11 reflects some earlier, more powerful fixed artillery pieces designed before the rise of the Empire. Golan Arms threw in with the Rebel Alliance (losing half of its factories to the Empire in the process) and provided the Rebels with these launchers.



## BURST RADIUS

Some weapons (including flechette launchers, rockets, and grenades) deal damage in an area rather than to a single target. That area is referred to as the weapon's burst radius and is given in parentheses along with the weapon's range increment entry. The burst radius is centered on a particular 2-meter-by-2-meter space (which is not necessarily occupied by a creature or an object) and extends out in all directions to the given distance.

For instance, a weapon with a 2-meter burst radius deals damage to anything in the space where it lands, and to anything located in any of the eight 2-meter-by-2-meter spaces adjacent to the center space. A 4-meter burst radius extends outward to all the spaces that are adjacent to the spaces within the 2-meter radius. ☺

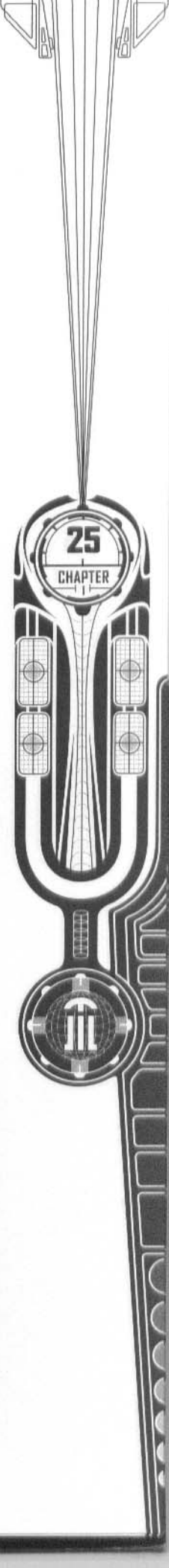

### Malaxan Firepower Incorporated FWG-5 Flechette Smart Pistol

**Weapon Type:** Flechette launcher pistol

**Proficiency Group:** Exotic  
(flechette launchers)

**Damage:** 3d8

**Range Increment:** 10 m (2 m)

**Fort DC:** —

**Multifire/Autofire:** —

**Hardness:** 5 **WP:** 8

**Availability:** Common, illegal

**Special:** This weapon fires 8 shots before needing to be reloaded. It uses an 8-shot clip of ammunition (cost 200).

**Cost:** 800

**Critical:** 20

**Weight:** 1.3 kg

**Type:** Slashing

**Size:** Small

**Break DC:** 12

**Era:** Ⓢ

A smaller (and, according to the sales brochure, "safer") flechette launcher than the Golan Arms FC11, the FWG-5 has been produced by Malaxan in the form of a handgun. The bulky canisters of the FC11 have been replaced with smaller, more aerodynamic pellets, crammed with flechettes backed by an explosive charge. These smaller pellets deliver the punch of the old FC11, but do so within a much smaller area.

### Salus DF-D1 Flechette Launcher

**Weapon Type:** Flechette launcher rifle

**Proficiency Group:** Exotic  
(flechette launchers)

**Damage:** 5d8

**Range Increment:** 12 m (4 m)

**Fort DC:** —

**Multifire/Autofire:** —

**Hardness:** 5 **WP:** 10

**Availability:** Common, illegal

**Special:** This weapon fires 6 shots before needing to be reloaded. It uses a 6-shot clip of ammunition (cost 600). Each additional range increment beyond the first provides a -4 penalty on the attack roll, instead of the normal -2.

**Cost:** 1,200

**Critical:** 20

**Weight:** 4.5 kg

**Type:** Slashing

**Size:** Medium-size

**Break DC:** 13

**Era:** Ⓢ

The Salus DF-D1 looks like a cut-down version of the FC11 with two barrels instead of four. It can be wielded as a rifle instead of being rested on top of the shoulder.

The Salus Combine sought to steal this weapon's design from Golan and produce a smaller model for the Empire. The resulting weapon, while impressive, proved to be erratic at longer ranges, and after one near-miss too many on the battlefield, the company was absorbed by Imperial Munitions and the weapon dropped from production.

## Crossbows and Magna Casters

Also called autocasters because of their similarity to the Wookiee bowcaster, crossbows are ancient weapons used by some sport hunters and a few assassins. Versions of this weapon are found in museums and private collections throughout the galaxy, but the Drolan Corporation has maintained a small but loyal customer base for its designs for generations.

Magna casters are a distant relative to the Wookiee bowcaster, though most lack the distinctive crossarm design of both crossbows and bowcasters. A magna caster uses a portable magnetic field generator to accelerate its arrowlike quarrels to a high velocity in a very short distance. This technology produces a weapon with great firepower, but which is very quiet—an advantage to both hunters and assassins.

Crossbow quarrels (and normal arrows) may be custom-made in the same fashion as darts, with a variety of deadly payloads (see the Special Dart Ammunition sidebar).

Crossbows and magna casters cannot be used in autofire mode and cannot be set on stun.

### Drolan Plasteel Repeating Crossbow

**Weapon Type:** Crossbow

**Proficiency Group:** Exotic (crossbows)

**Damage:** 1d8

**Range Increment:** 16 m

**Fort DC:** —

**Multifire/Autofire:** M

**Hardness:** 4 **WP:** 8

**Availability:** Specialized

**Special:** This weapon fires 10 shots before needing to be reloaded. It uses quarrels (cost 40 per 10 quarrels). It takes a full-round action to reload.

**Cost:** 400

**Critical:** 20

**Weight:** 1.2 kg

**Type:** Piercing

**Size:** Medium-size

**Break DC:** 12

**Era:** Ⓢ Ⓣ Ⓤ

The Drolan repeating crossbow looks like a cross between a bowcaster and a rifle. It is made of lightweight plasteel and has a large underslung bin for holding ammunition. As each quarrel is fired, the next is brought up to the firing groove while the bowstring is automatically recocked, allowing multiple shots in a single round.

### Frohard's Galactic Firearms Magna Caster-100

**Weapon Type:** Magna caster

**Proficiency Group:** Exotic (magna casters)

**Damage:** 3d8

**Range Increment:** 20 m

**Fort DC:** —

**Multifire/Autofire:** M

**Hardness:** 4 **WP:** 4

**Availability:** Common, restricted

**Special:** This weapon fires 10 shots before needing to be reloaded. It uses a 10-shot clip of ammunition (cost 150).

**Cost:** 2,000

**Critical:** 20

**Weight:** 4 kg

**Type:** Piercing

**Size:** Medium-size

**Break DC:** 15

**Era:** Ⓢ

The Magna Caster-100 is the most recent of several attempts to duplicate the simplicity of the Wookiee bowcaster. While the weapon is dominated by a large, thick barrel containing the magnetic field generator, the magna caster produces neither the power nor the penetration of the Wookiee weapon, nor do its quarrels take on the signature blazing energy sheath of a bowcaster bolt when fired. For most buyers of the Magna Caster-100, this feature is preferable, since their prey tend to be easily spooked by loud noises and bright lights.

## Wrist Weapons

Wrist weapons represent a variety of different projectile types—crossbowlike casters, self-propelled rockets, and metal blade launchers. In each case, however, the weapon is worn and used in a similar fashion—strapped across the back of the wrist or forearm and fired over the back of the hand.

The advantage of wrist weapons is that they may be easily concealed beneath robes or even bulky sleeves. In addition, as with combat gloves, the user of a wrist weapon cannot lose his weapon or be disarmed—though the weapon can, of course, still be destroyed.

Using wrist weapons effectively requires the Exotic Weapon Proficiency (wrist weapons) feat. An individual with this feat may use any wrist weapon.

A wrist weapon may be worn on either wrist or both. As a general rule, it cannot be used in multifire or autofire mode, and it cannot be set on stun.



## WRIST ROCKET AMMUNITION

Numerous types of rockets are available for the Kelvarek Consolidated Arms MM9 Rocket System. Just a few are detailed here.

In addition to the wide variety of rockets described here, creative bounty hunters often concoct their own specialized ammo. Further, a truly paranoid user may hook up additional weapon systems to his rocket system control pack. Boba Fett, famous for his many kills, was known to have a small flamer mounted on his wrist rocket launcher in addition to his other weapons.

### Locris Syndicated Securities Type-12A Explosive Antipersonnel Rocket

**Damage:** 3d8 **Range Increment:** 6 m (4 m)  
**Type:** Slashing **Cost:** 400

**Availability:** Common, military

**Special:** This weapon functions as a frag grenade (Reflex DC 15 for half damage), except that it cannot target a space.

### Merr-Sonn K26 Explosive Antivehicle Rocket

**Damage:** 4d8 **Range Increment:** 10 m (2 m)  
**Type:** Slashing **Cost:** 500

**Availability:** Common, military

**Special:** This weapon functions as a frag grenade (Reflex DC 15 for half damage), except that it cannot target a space.

### Locris Syndicated Securities Type 12-B Hollow-Tip Rocket with FGA-583 Nerve Toxin

**Damage:** 2d6 **Range Increment:** 6 m  
**Type:** Piercing **Cost:** 600

**Availability:** Rare, illegal

**Special:** Injury poison (Fort DC 15), initial damage 1d6 Con, secondary damage 2d6 Con. This weapon must deal wound damage for the toxin to take effect.

### Locris Syndicated Securities Type 12-B Hollow-Tip Rocket with Accudrop Stun Gas

**Damage:** 2d6 **Range Increment:** 6 m (2 m)  
**Type:** Piercing **Cost:** 400

**Availability:** Common, restricted

**Special:** This weapon fills the target area with a 2-meter-radius cloud of gas. The gas is an inhaled poison (Fort DC 18), initial damage 1d6 Dex, secondary damage unconsciousness.

### Locris Syndicated Securities Type 12-B Hollow-Tip Rocket, Empty

**Damage:** 2d6 **Range Increment:** 6 m  
**Type:** Piercing **Cost:** 200

**Availability:** Common

### Merr-Sonn DEMP Ionization Blast Rocket

**Damage:** 3d6 **Range Increment:** 6 m (2 m)  
**Type:** Energy **Cost:** 400

**Fort DC:** 18

**Availability:** Common, restricted

**Special:** Damage affects droids and cybernetic systems only.

### BlasTech Lumablast Rocket

**Damage:** Special **Range Increment:** 10 m (4 m)  
**Type:** Energy **Cost:** 400

**Availability:** Common, restricted

**Special:** Every creature within the burst radius must make a Fortitude save (DC 15) or be blinded for 1d4+1 rounds.

### Kelvarek "Dumb" Energy Quarrel

**Damage:** 2d6 **Range Increment:** 6 m  
**Type:** Energy **Cost:** 50

**Availability:** Prevalent, restricted

### Drolan Plasteel QuickShot Wrist-Caster

**Weapon Type:** Wrist-mounted crossbow

**Proficiency Group:** Exotic (wrist weapons) **Cost:** 500

**Damage:** 1d4 **Critical:** 20

**Range Increment:** 4 m **Weight:** 1 kg

**Fort DC:** — **Type:** Piercing

**Multifire/Autofire:** — **Size:** Small

**Hardness:** 4 **WP:** 2 **Break DC:** 12

**Availability:** Common, restricted **Era:** ⚙️

**Special:** This weapon must be reloaded after each shot. It uses quarrels (cost 10 for 10 quarrels).

Produced during the elegant age of the Old Republic but little seen in later eras, the Drolan QuickShot is a crossbow mounted on a forearm sleeve, designed to be worn under heavy robes. One quarrel is usually nocked for firing, and up to four more are stored in the sleeve for future use. The specially made QuickShot quarrels may be modified in the same manner as special dart ammunition (see the sidebar).

QuickShots have largely been superseded by hold-out blasters and dart pistols, but they still have a niche—especially when one wishes to greet a potential opponent with open (and apparently empty) hands. Drolan has not made these weapons since the Rise of the Empire era, but a lot of surplus QuickShots remain easily available on the market.

The company does not make any specially modified ammunition, but third parties often do.

### Golan Arms Vac Attack Mk-127

**Weapon Type:** Wrist-mounted blade launcher

**Proficiency Group:** Exotic (wrist weapons) **Cost:** 700

**Damage:** 3d8 **Critical:** 20

**Range Increment:** 4 m **Weight:** 1 kg

**Fort DC:** — **Type:** Slashing

**Multifire/Autofire:** — **Size:** Small

**Hardness:** 4 **WP:** 2 **Break DC:** 14

**Availability:** Common, restricted **Era:** ⚙️

**Special:** This weapon fires 2 shots before needing to be reloaded. It uses a 2-shot clip of ammunition (cost 50).

The Mk-127 is mounted on the forearm just behind the wrist with a secure metallic band. A shot from this weapon consists of a trio of 3-centimeter-diameter circular blades launched spinning toward its target at high speed.

The Mk-127 was originally manufactured by the Vacutech Combine, which went out of business due to problems with the Imperial bureaucracy. Golan Arms purchased both the company and its patents, and released the Vac Attack Mk-127 less than a year later.

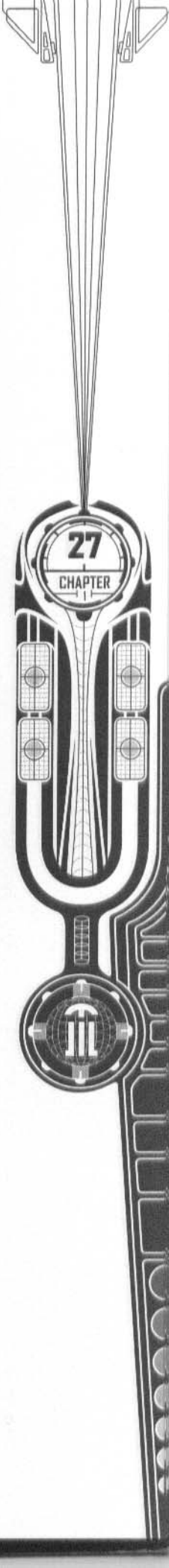

### Kelvarek Consolidated Arms MM9 Rocket System

**Weapon Type:** Wrist-mounted rocket launcher  
**Proficiency Group:** Exotic (wrist weapons) **Cost:** 2,500  
**Damage:** Varies **Critical:** Varies  
**Range Increment:** 6 m, unless otherwise noted **Weight:** 1 kg  
**Fort DC:** — **Type:** Varies  
**Multifire/Autofire:** — **Size:** Small  
**Hardness:** 4 **WP:** 4 **Break DC:** 15  
**Availability:** Common, restricted **Era:** Ⓢ  
**Special:** This weapon must be reloaded after each shot. It uses individual rockets (cost varies; see the Wrist Rocket Ammunition sidebar).

The ultimate in versatility, the MM9 rocket system can deliver a variety of payloads according to the needs and pocketbook of the user. Extremely popular with bounty hunters—and equally unpopular with government organizations—this miniature rocket launcher attaches to the arm just behind the wrist and overhangs the back of the hand, alleviating the user's worry about inadvertently shooting his or her hand off.

Rockets that miss their targets are treated as grenadelike weapons for purposes of determining where they land. (see Chapter Eight of the *Star Wars Roleplaying Game*).

### Prax Arms LG-5 Laser Gauntlet

**Weapon Type:** Wrist-mounted laser  
**Proficiency Group:** Exotic (wrist weapons) **Cost:** 1,500  
**Damage:** 2d4 **Critical:** 20  
**Range Increment:** 10 m **Weight:** 1 kg  
**Fort DC:** — **Type:** Energy  
**Multifire/Autofire:** — **Size:** Small  
**Hardness:** 5 **WP:** 5 **Break DC:** 17  
**Availability:** Common, restricted **Era:** Ⓢ Ⓣ Ⓤ  
**Special:** This weapon fires 3 shots before needing to be reloaded. It is reloaded as a full-round action with a pack of three special energy cells (cost 210 per pack).

This mass-produced laser gauntlet is a matching pair of heavy gauntlets, one of which is equipped with a small, powerful laser projector. A nonpowered gauntlet comes with the weapon (or the buyer can pay twice the list price for weapons on both gauntlets). The beam is shot along the back of the first finger (for Humans) or equivalent digit.

The laser gauntlet gets its power from three energy cells contained in a pouch along the cuff. These cells provide enough energy for 1 shot each before needing to be replaced.

Prax Arms has produced laser gauntlets in a variety of styles over the years to cover a variety of species and fashions. In addition, enterprising and fashion-conscious individuals have removed the firing elements of the LG-5 (as a modification) and installed them in gauntlets that meet their own needs.

## Melee Weapons

In many situations, a blaster just won't do the trick—particularly when your opponent is right on top of you. At this point, blades are drawn, punches are thrown, and melee weapons are of supreme importance.

Melee weapons fall into three categories.

Standard melee weapons include typical weapons found throughout the galaxy (clubs and swords, for example) as well as exotic weapons utilized by particular species—the gaderffii used by the Tusken Raiders on Tatooine, for example, or the rykk blade favored by Wookiees (see below).

Vibro weapons are bladed, powered melee weapons that use reverberating ultrasonics along the blades to deal considerable damage for their size. Most vibro weapons deal conventional damage, but a few weapons, such as the force pike, can deal stun damage as well.

Finally, full-fledged stun weapons use electrostatic charges to incapacitate their targets.

A melee weapon that uses energy cells or a power pack must have its power source replaced after the weapon scores 20 hits.

### Standard Melee Weapons

Many standard melee weapons have the advantage of being relatively easy to use and not requiring power packs or energy cells to function. They include simple weapons such as clubs and spears, as well as more ornate and specialized manufactured goods and weapons that have a special place within the heritage of a particular planet or species.

### Drolan Plasteel Sword (Typical Modern Longsword)

**Weapon Type:** Melee weapon  
**Proficiency Group:** Exotic (swords) **Cost:** 150  
**Damage:** 1d8 **Critical:** 20  
**Weight:** 2 kg **Type:** Slashing  
**Fort DC:** — **Size:** Medium-size  
**Hardness:** 10 **WP:** 2 **Break DC:** 16  
**Availability:** Prevalent **Era:** Ⓢ Ⓣ Ⓤ

Swords are long-bladed weapons (longer than knives) made of metal, plasteel, or highly bonded poly-layered ceramic. They are wielded primarily on worlds where high technology is absent, sometimes used as ceremonial weapons, and occasionally found among private collections. Traditional swords have been superseded in common use by vibroblades. Unlike vibroblades, swords are not illegal, though their similarity in appearance may result in a user being stopped and questioned by local authorities.

### Garrote

**Weapon Type:** Melee weapon  
**Proficiency Group:** Exotic (garrote) **Cost:** 50  
**Damage:** 1d6 **Critical:** —  
**Weight:** 0.5 kg **Type:** Slashing  
**Fort DC:** — **Size:** Small  
**Hardness:** 3 **WP:** 2 **Break DC:** 16  
**Availability:** Prevalent **Era:** Ⓢ Ⓣ Ⓤ

Garrotes range from simple knotted cloths (which deal bludgeoning damage and have a break DC of 10) to dura-steel spun wires (as described in the statistics above). Regardless of type, the purpose of a garrote is to cut off an opponent's air supply and crush his or her throat.

A garrote can be used only with a successful grapple check. For each round after the first that it remains around the target's throat, the garrote deals an additional 1d6 points of damage, and in the round after the garrote was attached, the target begins to suffocate. A target in combat can only hold his breath for a number of rounds equal to his Constitution score (this is different from normal drowning or suffocation because the individual is actively struggling) before succumbing to the effects of suffocation.

Garrotes can be used only against creatures with easily encompassed throats. Any form of armor, including natural armor, prevents the use of a garrote. Breaking the grapple ends the ongoing garrote damage.

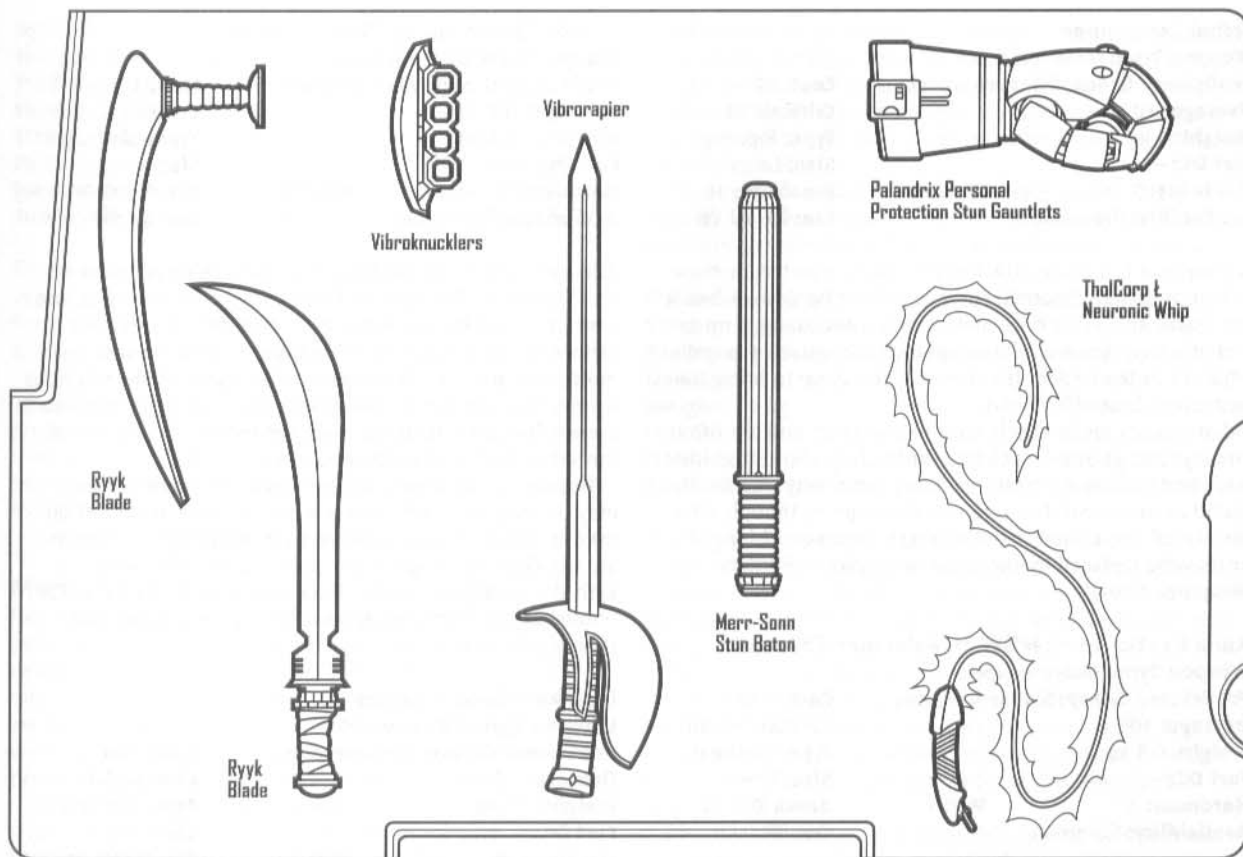

#### Merr-Sonn Snap Baton

**Weapon Type:** Melee weapon  
**Proficiency Group:** Simple weapons  
**Damage:** 1d6+1  
**Weight:** 1 kg  
**Fort DC:** —  
**Hardness:** 5      **WP:** 5  
**Availability:** Prevalent

**Cost:** 100  
**Critical:** 20  
**Type:** Bludgeoning  
**Size:** Medium-size  
**Break DC:** 17  
**Era:** 🌌 🗓 🌐

A collapsible baton that expands from a 12-centimeter cylinder to a full meter-long club, the snap baton is easily carried and just as easily deployed. Several types are on the market, but the Merr-Sonn version is coated with a thin layer of black sound-dampening material to reduce the noise it makes when it hits a target. Snap batons are particularly popular in urban centers, both as weapons for thugs and as items of personal protection.

#### Ryyk Blade

**Weapon Type:** Melee weapon  
**Proficiency Group:** Exotic (ryyk blade)  
**Damage:** 3d4  
**Weight:** 1.5 kg  
**Fort DC:** —  
**Hardness:** 10      **WP:** 3  
**Availability:** Specialized

**Cost:** 500  
**Critical:** 20  
**Type:** Slashing  
**Size:** Small  
**Break DC:** 15  
**Era:** 🌌 🗓 🌐

The traditional melee weapon of the Wookiees of Kashyyyk, a ryyk blade is a long machete with a hide-wrapped grip. Blade and grip designs vary widely among the Wookiee clans, but all have their origin in broad blades originally used

to clear overgrowth and later adapted into melee weapons. Wookiees sometimes utilize just one blade, but those with the proper training fight in a two-handed style that is both graceful and deadly.

The ryyk blade is primarily a Wookiee weapon, and a non-Wookiee using one attracts attention from Wookiees. A wielder is advised to be able to understand Shyriiwook, and to have a good explanation why he or she is using this weapon.

#### Sancretti Arms Whip (Typical Whip)

**Weapon Type:** Melee weapon  
**Proficiency Group:** Exotic (whip)  
**Damage:** 1d3  
**Weight:** 1.5 kg  
**Fort DC:** —  
**Hardness:** 4      **WP:** 2  
**Availability:** Prevalent

**Cost:** 100  
**Critical:** —  
**Type:** Slashing  
**Size:** Small  
**Break DC:** 12  
**Era:** 🌌 🗓 🌐

**Special:** This weapon never affects the wound points of its target. Any type of manufactured or natural armor negates a whip's damage. A whip has a maximum range of 4 meters, and the user may attack anything within that area, including an adjacent opponent. It may be used to trip an opponent, and the user can drop it if the attempt fails, thus preventing the opponent from tripping the user. This weapon grants the user a +2 bonus on attack rolls made to disarm, including the roll to avoid being disarmed in turn.

A whip is a long, ropelike weapon made of braided leather, metal, or some other supple, ductile material. The Sancretti Arms version is made of spun cables of bantha hide.

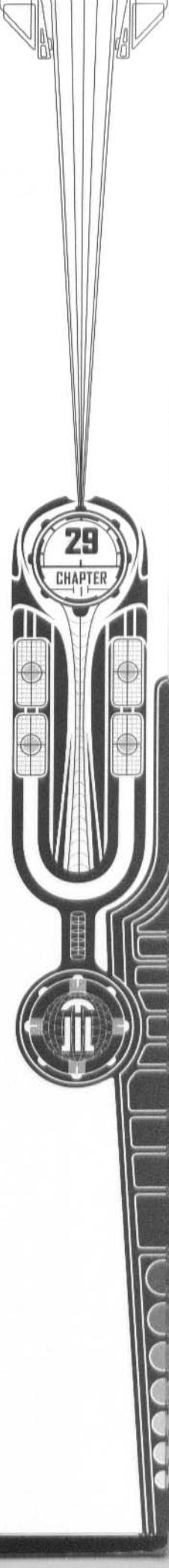

### Tribal Longspear

**Weapon Type:** Melee weapon  
**Proficiency Group:** Primitive weapons  
**Damage:** 1d8  
**Weight:** 4 kg  
**Fort DC:** —  
**Hardness:** 5  
**Availability:** Prevalent

**WP:** 5  
**Cost:** 80  
**Critical:** 20  
**Type:** Piercing  
**Size:** Large  
**Break DC:** 16  
**Era:** Ⓢ Ⓣ Ⓤ

A longspear is a blade attached to a shaft 2 meters or more in length. Unlike a normal spear, it cannot be thrown, but it has reach, and as such its wielder may attack targets up to 4 meters away. However, the weapon cannot attack a target adjacent to the wielder (the target is too close to bring the weapon to bear effectively).

Longspears are relatively easy to construct and are often employed in primitive societies, particularly those that hunt large and dangerous creatures. Longspears may also be found as ornamental or ceremonial weapons, though after the rise of the Empire most of these ornamental longs-pears were replaced by the great force pike (see Vibro Weapons, below).

### Xana Exotic Arms MSW-9 Molecular Stiletto

**Weapon Type:** Melee weapon  
**Proficiency Group:** Simple weapons  
**Damage:** 1d6  
**Weight:** 0.5 kg  
**Fort DC:** —  
**Hardness:** 3  
**Availability:** Common

**WP:** 1  
**Cost:** 700  
**Critical:** 19–20  
**Type:** Slashing  
**Size:** Tiny  
**Break DC:** 12  
**Era:** Ⓢ

A high-technology melee weapon, the molecular stiletto looks like a datapad stylus. Upon the activation of a control stud, a 30-centimeter-long monomolecular blade springs from the tip. This blade is a single molecule in thickness, and although it is fragile in comparison to other blades, it can deal significant damage.

Xana Exotic Arms is a corporation whose owners are hidden behind a maze of false names, holding companies, and shell corporations. They hold the designs to monomolecular blades as proprietary, and have neither licensed them out nor revealed the secret of the blades' manufacture.

### Vibro Weapons

Vibro weapons are powered weapons, requiring energy cells to function. They generally have metallic blades that are sheathed in an ultrasonic field, causing the blades to vibrate very quickly. An unpowered vibro weapon functions as a standard melee weapon of the same general type (treat such a weapon as a club if no conventional equivalent exists).

The wide variety of vibro weapons includes the vibrodagger; the large, swordlike vibroblade; and several models of vibro-ax, as well as the other types described here. A similar weapon is the force pike, which, unlike other vibro weapons, is designed to release a stun charge instead of ultrasonic damage. Merr-Sonn, SoroSuub, and Czerka all make standard vibro weapons.

Unless otherwise noted, vibro weapons emit an audible, high-pitched sound when they are powered—individuals gain a +2 circumstance bonus on Listen checks when attempting to hear a target carrying a powered vibro weapon.

### Czerka Great Force Pike

**Weapon Type:** Melee weapon  
**Proficiency Group:** Vibro weapons  
**Damage:** 3d8  
**Weight:** 2.8 kg  
**Fort DC:** 18  
**Hardness:** 5  
**Availability:** Common

**Cost:** 1,000  
**Critical:** 20  
**Type:** Slashing  
**Size:** Large  
**Break DC:** 20  
**Era:** Ⓢ Ⓣ Ⓤ

A longer version of the force pike (see Chapter Seven of the *Star Wars Roleplaying Game*), the great force pike was commissioned by the Imperial Throne from Czerka for ceremonial and crowd control purposes, and the various moffs and grand moffs were awarded cases of the weapons for use by their ceremonial guards. Some of these weapons eventually found their way into the reception halls of various crime lords and petty dictators.

Because of its length, a great force pike has reach and may be used to attack targets 4 meters away. It cannot be used to attack targets adjacent to its wielder (such targets are too close to bring the weapon to bear effectively). As with the force pike, a great force pike may be set either for normal or stun damage. A great force pike requires four energy cells to operate.

### Czerka Vibroknuclers

**Weapon Type:** Melee weapon  
**Proficiency Group:** Vibro weapons  
**Damage:** 1d6+1  
**Weight:** 0.5 kg  
**Fort DC:** —  
**Hardness:** 5  
**Availability:** Common, restricted

**Cost:** 200  
**Critical:** 20  
**Type:** Slashing  
**Size:** Tiny  
**Break DC:** 14  
**Era:** Ⓢ Ⓣ Ⓤ

Vibroknuclers consist of a casing containing a power source (concealed in the palm of the hand) and a small blade that peeks out from between the backs of the knuckles.

An attacker wearing vibroknuclers cannot be disarmed. The weapons themselves, however, can be damaged. Vibroknuclers require an energy cell to operate. If unpowered, they deal 1d4 points of damage.

### LaserHone Duelist Vibrorapier

**Weapon Type:** Melee weapon  
**Proficiency Group:** Vibro weapons  
**Damage:** 2d6+2  
**Weight:** 1.4 kg  
**Fort DC:** —  
**Hardness:** 5  
**Availability:** Common, restricted  
**Special:** This weapon does not grant the +2 bonus on Listen checks common to other vibro weapons.

**Cost:** 500  
**Critical:** 20  
**Type:** Slashing  
**Size:** Medium-size  
**Break DC:** 17  
**Era:** Ⓢ Ⓣ Ⓤ

Made with a thinner, longer blade than that of a typical vibroblade, the LaserHone Duelist is extremely well balanced and appropriate for the professional fighter. LaserHone has succeeded in dampening the ultrasonic pitch, making the weapon totally silent. The Duelist is excellent for stealth work when using a blaster or a lightsaber would be unwise.

A vibrorapier requires two energy cells to function.

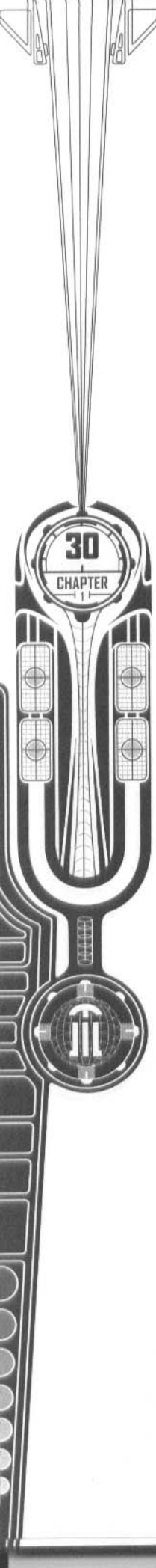

### Merr-Sonn Vibrobayonet

**Weapon Type:** Melee weapon  
**Proficiency Group:** Vibro weapons  
**Damage:** 2d4+2 or 2d4  
**Weight:** 1 kg  
**Fort DC:** —  
**Hardness:** 5 **WP:** 2  
**Availability:** Common, military

**Cost:** 200  
**Critical:** 20  
**Type:** Slashing  
**Size:** Small  
**Break DC:** 14  
**Era:** Ⓢ Ⓣ Ⓤ

Produced by Merr-Sonn to be attached to the E11 and other common models of blaster rifle, the vibrobayonet allows a trooper to use his or her rifle as a vibro weapon in close combat, dealing 2d4+2 points of damage.

A vibrobayonet has its own energy cell, so using it as an attachment on a blaster rifle does not deplete the rifle's power pack. A vibrobayonet used as a weapon by itself functions as a vibrodagger, dealing 2d4 points of damage. The Merr-Sonn weapon emits an obvious, deep buzz, the better to frighten defenders.

A vibrobayonet requires an energy cell to operate.

### Melee Stun Weapons

Not all weapons are designed with bloodshed as their chief purpose. Many weapons are intended to incapacitate opponents rather than kill them. The bulk of these stun their targets by means of an energy charge. Melee stun weapons are particularly preferred by local police units and corporate security forces, as well as by slavers who do not wish to permanently damage their merchandise.

Melee stun weapons are considered to be always set on stun. If a character is hit and fails a Fortitude save, he is knocked unconscious for 1d4+1 rounds. If the character succeeds at the Fortitude save, he is stunned for 1 round.

Melee stun weapons cannot normally affect targets in powered, medium, or heavy armor, or creatures with a natural armor bonus of +3 or higher.

### Merr-Sonn Stun Baton (Typical Stun Baton)

**Weapon Type:** Melee weapon  
**Proficiency Group:** Simple weapons  
**Damage:** —  
**Weight:** 1.8 kg  
**Fort DC:** 15  
**Hardness:** 5 **WP:** 5  
**Availability:** Prevalent, restricted

**Cost:** 50  
**Critical:** —  
**Type:** Bludgeoning  
**Size:** Medium-size  
**Break DC:** 17  
**Era:** Ⓢ Ⓣ Ⓤ

The simplest form of stun baton, this Merr-Sonn model is used by corporate agents and local police forces alike. Producing a mild charge, the stun baton can deal with most low-level urban disturbances. The original Merr-Sonn has been in production for decades, though sales spiked with the Rebellion and the fall of the Empire. An unpowered stun baton is treated as a normal club.

The stun baton requires an energy cell to operate.

### Merr-Sonn Z2 Stun Baton

**Weapon Type:** Melee weapon  
**Proficiency Group:** Simple weapons  
**Damage:** — (low) or 1d6 (high)  
**Weight:** 1.8 kg  
**Fort DC:** 15 (low) or 18 (high)  
**Hardness:** 5 **WP:** 5  
**Availability:** Common, restricted

**Cost:** 700  
**Critical:** —  
**Type:** Bludgeoning  
**Size:** Medium-size  
**Break DC:** 17  
**Era:** Ⓢ Ⓣ Ⓤ

A refinement of the original Merr-Sonn stun baton in a similar housing, the Merr-Sonn Z2 has an adjuster knob to kick up the weapon's effect to a new level. The higher setting deals normal damage on a successful strike in addition to stunning, but drains the energy cell after only 5 hits instead of the usual 20.

The weapon is used more by corporate agents and slavers than by local law enforcement. It is official policy in some locations to leave the setting at the higher level continually.

### Palandrax Personal Protection Stun Gauntlets

**Weapon Type:** Melee weapon  
**Proficiency Group:** Simple weapons  
**Damage:** —  
**Weight:** 1.8 kg  
**Fort DC:** 12  
**Hardness:** 5 **WP:** 5  
**Availability:** Prevalent

**Cost:** 500  
**Critical:** —  
**Type:** Bludgeoning  
**Size:** Medium-size  
**Break DC:** 14  
**Era:** Ⓢ Ⓣ Ⓤ

The fabric of these heavy gauntlets is interwoven with circuitry to deliver an electric shock when they hit. When they are powered, the gloves glow, and a noticeable electrical discharge is evident around them. The weapon requires two energy cells (one for each glove).

Palandrax makes its stun gauntlets to fit a variety of species, and any set of gloves is considered to be the same size weapon as the size of the species it is made for. The company primarily makes Medium-size gauntlets, though it will do special orders for Large or Small creatures (at ten times the list price).

An attacker wearing stun gauntlets cannot be disarmed. The gloves themselves, however, can be damaged.

Unpowered gauntlets function as normal gloves, providing no special benefit in combat.

### SoroSuub CS-12 Stun Master

**Weapon Type:** Melee weapon  
**Proficiency Group:** Simple weapons  
**Damage:** —  
**Weight:** 1.1 kg  
**Fort DC:** 18  
**Hardness:** 5 **WP:** 2  
**Availability:** Common, restricted

**Cost:** 700  
**Critical:** —  
**Type:** Bludgeoning  
**Size:** Small  
**Break DC:** 14  
**Era:** Ⓢ Ⓣ Ⓤ

Also called a contact stunner and sold as a personal protection device, the CS-12 consists of a small cylinder 15 centimeters long and 5 centimeters in diameter with a flat disk on the forward end from which protrude thirteen contact disks. If applied to a target, the stun master produces an extremely strong nonlethal charge. While tightly regulated, particularly on populous worlds, the Stun Master and other contact stunners are easily smuggled through customs and police inspections.

The CS-12 needs an energy cell to function. It deals no damage when unpowered.

### TholCorp Neuronic Whip

**Weapon Type:** Melee weapon  
**Proficiency Group:** Exotic (whip)  
**Damage:** 1d4 (normal) or 2d4 (stun)  
**Weight:** 1.8 kg  
**Fort DC:** 16  
**Hardness:** 5 **WP:** 3  
**Availability:** Rare, illegal

**Cost:** 700  
**Critical:** —  
**Type:** Slashing  
**Size:** Small  
**Break DC:** 14  
**Era:** Ⓢ Ⓣ Ⓤ

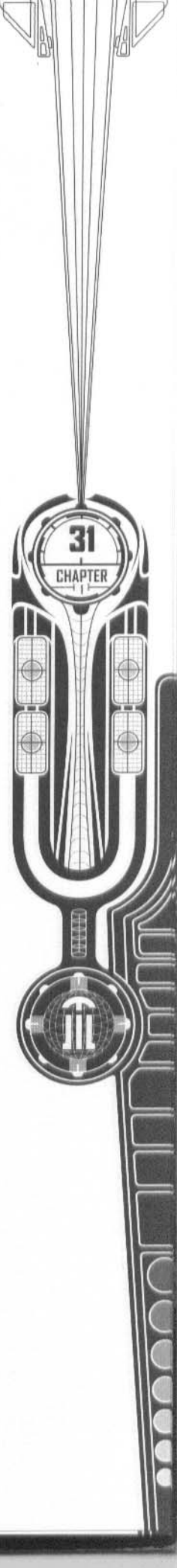

**Special:** This weapon cannot stun a creature wearing medium, heavy, or powered armor, or with a +3 or higher natural armor bonus. It has a maximum range of 4 meters, and the user may attack anything within that area, including an adjacent opponent. It may be used to trip an opponent, and the user can drop it if the attempt fails, thus preventing the opponent from tripping the user. This weapon grants the user a +2 bonus on attack rolls made to disarm, including the roll to avoid being disarmed in turn.

The neuronomic whip is a slaver's weapon, banned on a thousand worlds. With its capability to stun its target, a neuronomic whip is effective for keeping recalcitrant slaves in line.

The neuronomic whip has two settings—one for normal attacks, and one for stunning attacks. When set for a normal attack, the stunwhip functions exactly like a normal whip (covered just above). When set for its stun attack, the neuronomic whip emits a continuous low hum. It deals a powerful jolt (2d4 points of damage) and also delivers the effect of a weapon with a stun setting. Most armored creatures are not vulnerable to the stun effect, but they still take the higher damage when the weapon hits.

## Grenades and Other Explosives

Explosives are thrown at or placed near their targets, and they can create a diverse number of effects. Also, unlike most weapons, grenades and explosives are expended when they are used (though some special grenades may be salvaged and later reused).

While grenades and other explosives are sold primarily to military organizations, their large manufacturing runs and small size ensure that a sizable number of them end up on the black market.

### Grenades

Grenades are small thrown weapons that explode to affect a large area. The most common grenades are fragmentation (frag) grenades and stun grenades.

Grenades are usually thrown, but their range may be drastically increased by the use of a grenade launcher (see the following section). Grenade launchers are usually found only in the possession of military organizations, but sometimes work their way into the hands of paramilitary and criminal groups.

Unless otherwise noted, grenades explode on contact.

#### Czerka Chemical Load Grenade

**Weapon Type:** Grenade

**Proficiency Group:** Simple weapons

**Damage:** Special

**Range Increment:** 4 m (4 m)

**Fort DC:** —

**Multifire/Autofire:** —

**Hardness:** 2

**WP:** 2

**Availability:** Prevalent, military

**Cost:** Varies by load

**Critical:** —

**Weight:** 0.5 kg

**Type:** Special

**Size:** Tiny

**Break DC:** 15

**Era:** Ⓢ Ⓜ Ⓝ

These specially made custom grenades are filled and prepared at the factory and (under Czerka's trade agreements) clearly labeled as to their content. Each grenade contains a specific chemical payload, which affects targets within the grenade's burst radius depending on its type.

**Agent T-238** is a debilitating nausea-inducing chemical. Those within the burst radius must make a Fortitude save (DC 15) or be stricken with nausea for the next 1d4 hours (treat as exhausted). *Cost:* 650.

**Fax-M3** is a deadly nerve toxin released in aerosol form. It is an inhaled poison (Fort DC 15), initial damage 1d6 Con, secondary damage 2d6 Con. *Cost:* 1,050.

**Smoke** payloads produce smoke in the burst radius in gray, white, or various colors. Those within that area suffer the effects of smoke (as discussed in Chapter Twelve of the *Star Wars Roleplaying Game*) and gain one-half concealment (20% miss chance). *Cost:* 150.

**Plank Gas** is a corrosive chemical that deals 1d6 points of damage to all targets and objects in the burst radius each round for 3 rounds. A successful Reflex save (DC 15) each round negates the effect, as does moving out of the burst radius. *Cost:* 850.

The shell of a chemical load grenade disintegrates upon use; chemical load grenades cannot be refilled.

#### Czerka Spore/B Stun Grenade

**Weapon Type:** Grenade

**Proficiency Group:** Simple weapons

**Damage:** —

**Range Increment:** 4 m (4 m)

**Fort DC:** 17

**Multifire/Autofire:** —

**Hardness:** 2

**WP:** 2

**Availability:** Prevalent, military

**Special:** This weapon does no damage to targets in sealed suits such as powered armor, targets that do not breathe, and targets that are breathing through the use of respirators.

**Cost:** 700

**Critical:** —

**Weight:** 0.5 kg

**Type:** Special

**Size:** Tiny

**Break DC:** 15

**Era:** Ⓢ Ⓜ Ⓝ

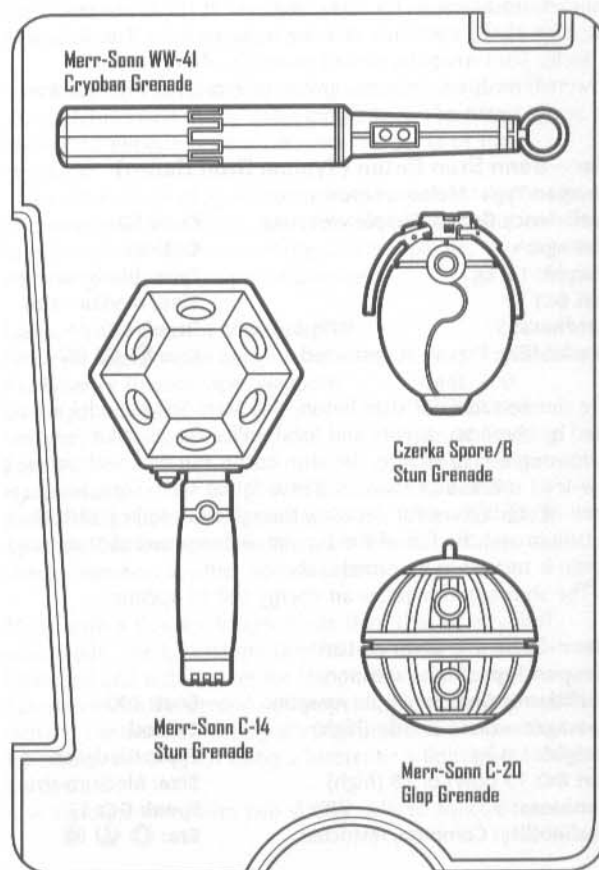

Merr-Sonn WW-41  
Cryoban Grenade

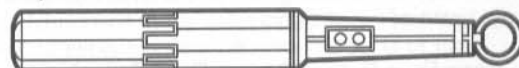

Merr-Sonn C-14  
Stun Grenade



Czerka Spore/B  
Stun Grenade



Merr-Sonn C-20  
Glap Grenade



This plum-shaped grenade explodes on contact, filling the burst radius with a swarm of Bothan stun spores. These spores are inhaled and numb the targets' respiratory systems, causing the those within the blast area to immediately go unconscious.

Those within the burst radius of the grenade must make a Fortitude save (DC 17) to avoid being knocked unconscious for 2d6 rounds. Success on the save results in being stunned for 1 round.

An individual who fails the saving throw by 10 or more begins to suffocate (see Suffocation and Drowning in Chapter Twelve of the *Star Wars Roleplaying Game*). A successful Treat Injury check (DC 17) allows the individual to be resuscitated. Otherwise, the individual is in danger of dying.

#### Graff-Timms 0033X Grenade

**Weapon Type:** Grenade

**Proficiency Group:** Simple weapons

**Damage:** 2d6

**Range Increment:** 4 m (2 m)

**Fort DC:** —

**Multifire/Autofire:** —

**Hardness:** 2

**WP:** 2

**Availability:** Rare

**Special:** Targets within the burst radius may make a Reflex save (DC 15) for half damage.

**Cost:** 400

**Critical:** —

**Weight:** 0.5 kg

**Type:** Slashing

**Size:** Tiny

**Break DC:** 15

**Era:** ☉

A relic of the past, the 0033X was the grenade used by Old Republic jump troopers long ago. The grenades are not currently being made, though they were manufactured in such numbers that they are still in use in certain locations.

#### Merr-Sonn C-10 Stun Grenade (Typical Stun Grenade)

**Weapon Type:** Grenade

**Proficiency Group:** Simple weapons

**Damage:** —

**Range Increment:** 4 m (4 m)

**Fort DC:** 15/12 (see text)

**Multifire/Autofire:** —

**Hardness:** 2

**WP:** 2

**Availability:** Prevalent, military

**Cost:** 600

**Critical:** —

**Weight:** 0.5 kg

**Type:** Energy

**Size:** Tiny

**Break DC:** 15

**Era:** ☉ ☽ ☿

The C-10 is a smooth grenade lacking the chrome shield common to the C-16 and C-22 (see below). The purpose of the stun grenade is to knock targets unconscious with a sudden concussive blast. This concussive energy causes the target to make a Fortitude save (DC 15 if hit by the grenade, DC 12 if in an adjacent space). Those making the save are stunned for 1 round. Those failing the save are knocked unconscious for 1d4+1 rounds.

#### Merr-Sonn C-14A Stun Grenade

**Weapon Type:** Grenade

**Proficiency Group:** Simple weapons

**Damage:** —

**Range Increment:** 4 m (4 m)

**Fort DC:** 12

**Multifire/Autofire:** —

**Hardness:** 2

**WP:** 2

**Availability:** Prevalent, military

**Cost:** 500

**Critical:** —

**Weight:** 0.5 kg

**Type:** Energy

**Size:** Tiny

**Break DC:** 15

**Era:** ☽

A multifaceted metallic sphere with a clublike handle, the C-14A is dotted with beamsplitters. It discharges when it hits

the ground, bathing the burst radius in a brilliant energy field. Stun grenades of this type are used for crowd control.

Targets in the blast area of this stun grenade must make a Fortitude save (DC 12) or be knocked unconscious for 1d4+1 rounds. A target that makes a successful save is stunned for 1 round.

The original C-14 model was developed for Imperial Munitions. It was designed so that it could be recovered, recharged, and reused. Much to the chagrin of the designers, recovered C-14s often cropped up in later battles against the very troops that had used them initially. The later version (the C-14A detailed here) requires a Repair check (DC 15) to reactivate it. This particular weapon has fallen out of favor by the time of The New Jedi Order era.

#### Merr-Sonn C-16 Fragmentation Grenade (Typical Frag Grenade)

**Weapon Type:** Grenade

**Proficiency Group:** Simple weapons

**Damage:** 4d6+1

**Range Increment:** 4 m (4 m)

**Fort DC:** —

**Multifire/Autofire:** —

**Hardness:** 2

**WP:** 2

**Availability:** Prevalent, military

**Special:** Targets within the burst radius may make a Reflex save (DC 15) for half damage.

**Cost:** 500

**Critical:** —

**Weight:** 0.5 kg

**Type:** Slashing

**Size:** Tiny

**Break DC:** 15

**Era:** ☉ ☽ ☿

The Merr-Sonn C-16 contains a detonite charge in the center of its casing, wrapped in a prestressed chrome shell that fills the burst radius with a flurry of metal shards. The C-16 was popular with Rebel forces during the Galactic Civil War, but the same type of grenade can be found in all eras of play.

#### Merr-Sonn C-22 Fragmentation Grenade

**Weapon Type:** Grenade

**Proficiency Group:** Simple weapons

**Damage:** 4d6

**Range Increment:** 4 m (4 m)

**Fort DC:** —

**Multifire/Autofire:** —

**Hardness:** 2

**WP:** 2

**Availability:** Prevalent, military

**Special:** This weapon has a timer that allows the grenade to go off in any round up to 20 rounds after being set. The timer can be deactivated with a special code (as a move action or attack action), or with a Demolitions check against DC 15 (as a full-round action). Targets within the burst radius may make a Reflex save (DC 15) for half damage.

**Cost:** 700

**Critical:** —

**Weight:** 0.5 kg

**Type:** Slashing

**Size:** Tiny

**Break DC:** 15

**Era:** ☉ ☽ ☿

More advanced than the C-16, the C-22 was more commonly used by Imperial forces during the Galactic Civil War. This grenade has a timer that can delay the weapon's explosion for up to 20 rounds; the timer can be deactivated by pressing down on the top and feeding in the correct code. The timer need not be used, however—without it, the C-22, like the C-16, simply explodes in the same round when it is thrown.

In addition, the C-22 has a weak magnetic grapple that allows it to be secured on (but not tossed against) vehicles.

#### Merr-Sonn G-20 Glap Grenade

**Weapon Type:** Grenade

**Proficiency Group:** Simple weapons

**Damage:** —

**Cost:** 600

**Critical:** —

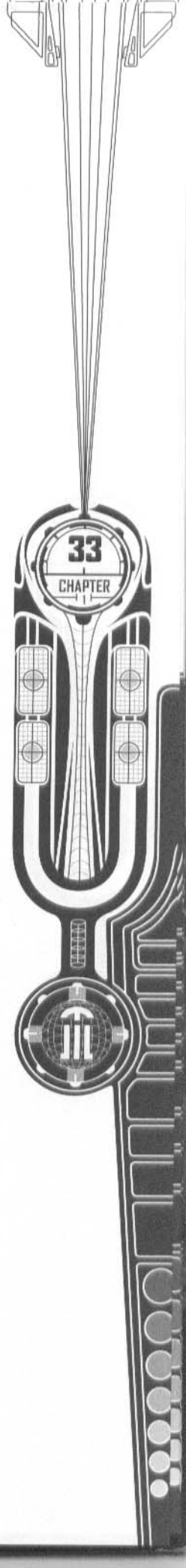

**Range Increment:** 4 m (4 m)

**Fort DC:** —

**Multifire/Autofire:** —

**Hardness:** 2

**WP:** 2

**Availability:** Prevalent, restricted

**Special:** This weapon has a timer that allows the grenade to go off in any round up to 3 rounds after being set. The timer can be deactivated with a Demolitions check against DC 15 (a full-round action).

**Weight:** 0.5 kg

**Type:** Special

**Size:** Tiny

**Break DC:** 15

**Era:**   

A spherical grenade, the G-20 sprays its burst radius with an adhesive foam that slows or completely imprisons its targets. It may explode on contact or as much as 3 rounds later and may be recharged (cost 100 to recharge, given proper facilities). Glop grenades do not produce injuries, and as such are advantageous in situations when no collateral damage is desired. They are used extensively in the Corporate Sector.

Those caught within the burst radius of a glop grenade must make a Reflex save (DC 15) or be held immobile by the glop; those who succeed must move at half speed until the glop is removed from their bodies. Regardless of the saving throw, those within the area of the glop are entangled (–2 penalty on attack rolls and –4 to Dexterity).

Stuck characters may break free with a Strength check (DC 27) or by dealing 18 points of energy damage to the glop. Freed characters still suffer attack and Dexterity penalties and move at half speed until the glop dries or is removed.

Glop becomes naturally brittle after 5 minutes. It may also be removed by glop dissolver, which frees a stuck character in 1 round and removes glop entirely in 1 round more. Glop dissolver is sold in aerosol packs of four applications for 50 credits. Each application is sufficient to clean up one individual.

#### Merr-Sonn WW-41 Cryoban Grenade

**Weapon Type:** Grenade

**Proficiency Group:** Simple weapons

**Damage:** 1d6 and special (see text)

**Range Increment:** 4 m (4 m)

**Fort DC:** —

**Multifire/Autofire:** —

**Hardness:** 2

**WP:** 2

**Availability:** Prevalent, military

**Special:** Those within the burst radius must make a Fortitude save (DC 15) or take an additional 1d6 points of damage. Heavy clothing negates the initial 1d6 points of damage and grants a +4 equipment bonus on the saving. This weapon does no damage to a target in a sealed suit such as powered armor.

**Cost:** 800

**Critical:** —

**Weight:** 0.5 kg

**Type:** Special

**Size:** Tiny

**Break DC:** 15

**Era:**  

A baton-shaped grenade, the Cryoban explodes on contact, creating within the burst radius a zone of sudden, intense cold. Intended primarily as a firefighting tool, the Cryoban snuffs all flames within the burst radius. It also harms living creatures and droids (the sudden cold affects delicate circuitry), but is less harmful to creatures protected from cold (such as those in heavy clothing).

#### Grenade Launchers

Grenade launchers are military weapons that radically improve the range of grenades. Those that are light enough to be carried by a single soldier fall into the blaster rifles proficiency group, while those large enough to require a tripod fall under the heavy weapons proficiency group. In addition to being carried by soldiers, heavy grenade launchers may be easily mounted on vehicles.

Grenades fired by grenade launchers always explode on impact, regardless of timers or other considerations. Grenade launchers fire one grenade per round. Grenades fired by a launcher are still subject to deviation if they miss their target (see Grenadelike Weapons in Chapter Eight of the *Star Wars Roleplaying Game*).

Grenade launchers generally cannot be used in autofire or multifire mode and cannot be set on stun.

#### Merr-Sonn GL-II/GL-11sa Handheld Grenade Launcher

**Weapon Type:** Grenade launcher

**Proficiency Group:** Blaster rifles

**Damage:** By grenade type

**Cost:** 2,000

**Critical:** By grenade type

**Weight:** 3 kg (see below)

**Type:** By grenade type

**Size:** Medium-size

**Break DC:** 15

**Era:**   

**Range Increment:** 30 m

(burst radius by grenade type)

**Fort DC:** —

**Multifire/Autofire:** —

**Hardness:** 5

**WP:** 5

**Availability:** Common, military

**Special:** This weapon fires 4 shots before needing to be reloaded as a full-round action.

Merr-Sonn is the leading manufacturer of grenade launchers, and the company has naturally tailored these weapons to fit its family of explosive devices. The GL-11 and GL-11sa are similar in appearance, using a blaster rifle stock but replacing the housing and galven circuitry with a chopped launcher barrel. The GL-11 fires C-16 frag grenades (see above), while the GL-11sa fires C-10 stun grenades.

#### Merr-Sonn MobileMortar-3

**Weapon Type:** Grenade launcher

**Proficiency Group:** Heavy weapons

**Damage:** By grenade type

**Cost:** 4,000

**Critical:** By grenade type

**Weight:** 20 kg/2 kg (see below)

**Type:** By grenade type

**Size:** Large

**Break DC:** 20

**Era:**   

**Range Increment:** 100 m

(burst radius by grenade type)

**Fort DC:** —

**Multifire/Autofire:** —

**Hardness:** 5

**WP:** 10

**Availability:** Common, military

**Special:** This weapon fires 12 shots before needing to be reloaded as a full-round action.

The Merr-Sonn MobileMortar-3 is a full-bore military weapon, complete with a small repulsorlift-equipped tripod that reduces the weapon's effective weight from 20 kg to 2 kg. The MobileMortar is designed to fire only C-22 frag grenades, but inspired soldiers (and others) do not let this fact get in the way of experimenting with other payloads, including the C-14A and the C-16.

#### SoroSuub TTT-54 "Thumper"

**Weapon Type:** Grenade launcher

**Proficiency Group:** Heavy weapons

**Damage:** By grenade type

**Cost:** 4,000

**Critical:** By grenade type

**Weight:** 20 kg

**Type:** By grenade type

**Size:** Large

**Break DC:** 20

**Era:**  

**Range Increment:** 50 m

(burst radius by grenade type)

**Fort DC:** —

**Multifire/Autofire:** —

**Hardness:** 5

**WP:** 10

**Availability:** Common, military

**Special:** This weapon fires 5 shots before needing to be reloaded as a full-round action. Changing this weapon's ammunition type is also a full-round action.

The BlasTech "Tees" is a low-tech weapon first produced by the Rebel Alliance and later licensed to SoroSuub for full production. Unlike the Merr-Sonn model, it lacks the repulsorlift and must be lugged into place, and it has a much shorter range. However, its adjustable grenade housing can be programmed to accommodate and fire any type of grenade, including a thermal detonator, with equal ease. The setting must be recalibrated for each new grenade, and the launcher will jam if different-sized grenades are in the same magazine.

## Other Weapons and Weapon Systems

Some weapons in the *Star Wars* universe do not fit into neat categories. They utilize special forms of energy, or require special rules, or represent unique, experimental, or uncommon weapon technology. This section covers these weapons and their special requirements.

### Flame Projectors

Flame projectors, also called flamers, shoot a jet of ignited liquid that has a short range but deals a large amount of damage—and may set targets aflame. The leading manufacturer of flame projectors is Merr-Sonn, and its designs have been licensed to Czerka, which produces almost identical models. Czerka also produces a wrist-mounted flamer.

A flame projector affects all the space between the weapon and the farthest extent of the flaming shot, which may be out to the maximum range of the weapon. Every 2-meter square along this line is affected, meaning that a flamer can harm multiple targets with a single shot. Any creature struck by a flamer may make a Reflex saving throw (DC varies by weapon) to take half damage.

Targets that are flammable may be set on fire, as per the rules for catching on fire in the *Star Wars Roleplaying Game*.

Effectively using a portable flame projector requires the Exotic Weapon Proficiency (flame projectors) feat. Heavier models are covered by Weapon Group Proficiency (heavy weapons). A character proficient with Exotic Weapons (flame projectors) can use any flamer that's based on this feat.

Flamers fire once per round and cannot be used in autofire or multifire mode.

Flame projectors have a weakness because they employ volatile, flammable chemicals under pressure. If the weapon is reduced to 0 wound points, it explodes, dealing 4d6 points of damage to anything within a 4-meter burst radius.

#### Czerka CZ Wrist-Mounted Flame Projector

**Weapon Type:** Flame projector

**Proficiency Group:** Exotic (flame projectors) **Cost:** 800

**Damage:** 2d6

**Critical:** 20

**Range Increment:** 2 m

**Weight:** 1 kg

**Fort DC:** —

**Type:** Energy

**Multifire/Autofire:** —

**Size:** Small

**Hardness:** 5 **WP:** 4

**Break DC:** 13

**Availability:** Common, illegal

**Era:**   

**Special:** This weapon fires 5 shots before needing to be reloaded. It uses a special ammunition canister (cost 30). This weapon fires a maximum of two range increments instead of the normal ten.

Czerka's sole original flamer design, predating the Merr-Sonn versions, the CZ is a thin, wandlike weapon mounted on the back of the wrist, with the projector jutting out alongside the outside of the hand beyond the fingers. The weapon is connected by a feeder tube to a small fuel canister worn on the back of the belt. The CZ is a good surprise weapon as well as an arsonist's friend.

Boba Fett has seriously modified his CZ, stripping off the housing and incorporating it into his Kelvarek MM9 wrist rocket system, as well as hooking up the firing mechanism to his internal computer link. This version of the weapon falls into the wrist weapons proficiency group.

#### Merr-Sonn Model C-22 Flame Carbine

**Weapon Type:** Flame projector

**Proficiency Group:** Exotic (flame projectors) **Cost:** 500

**Damage:** 4d6

**Critical:** 20

**Range Increment:** 2 m

**Weight:** 3 kg

**Fort DC:** —

**Type:** Energy

**Multifire/Autofire:** —

**Size:** Medium-size

**Hardness:** 4

**WP:** 5

**Break DC:** 15

**Availability:** Specialized, restricted

**Era:**   

**Special:** This weapon fires 10 shots before needing to be reloaded. It uses a special ammunition canister (cost 50). This weapon fires a maximum of four range increments instead of the normal ten.

Used in the Corporate Sector as a riot-control device of extreme effect, the flame carbine is a backup for the standard-issue blaster or riot gun. The fuel canister is worn

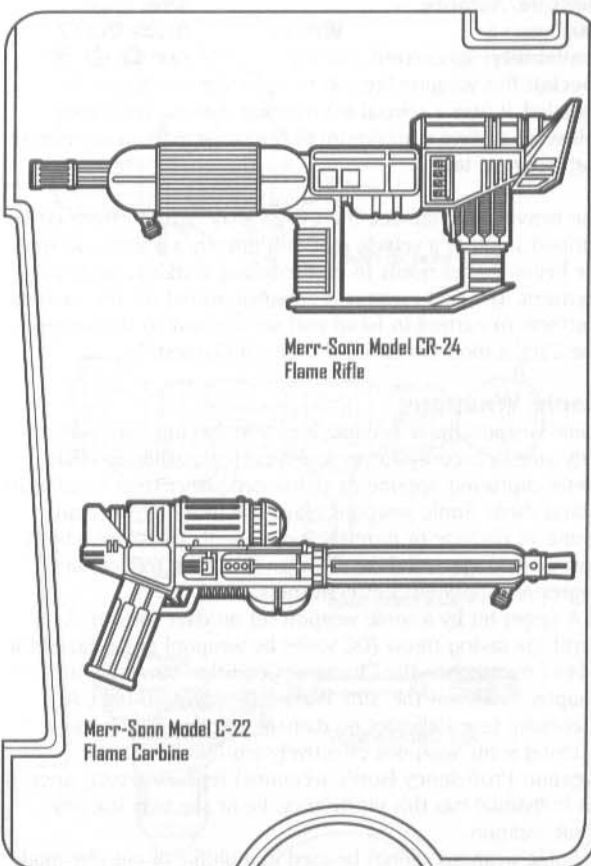

Merr-Sonn Model CR-24  
Flame Rifle

Merr-Sonn Model C-22  
Flame Carbine

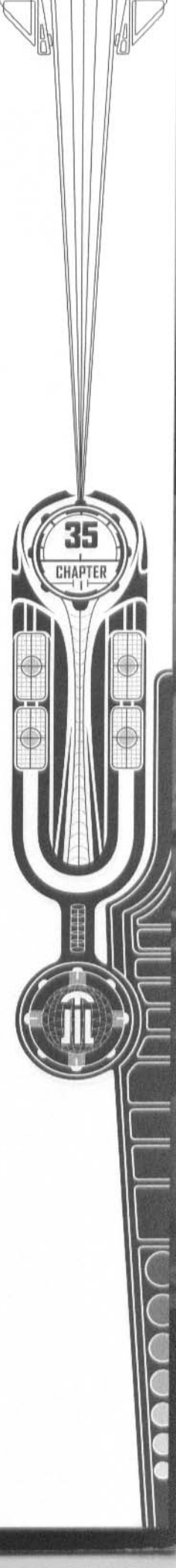

the belt and connected to the weapon by a flexible line. The Czerka model is called the CZ-22 Flametongue.

#### Merr-Sonn Model CR-24/Czerka CZ-24 Flamemaster Flame Rifle

**Weapon Type:** Flame projector  
**Proficiency Group:** Exotic (flame projectors) **Cost:** 700  
**Damage:** 5d6 **Critical:** 20  
**Range Increment:** 2 m **Weight:** 5 kg  
**Fort DC:** — **Type:** Energy  
**Multifire/Autofire:** — **Size:** Medium-size  
**Hardness:** 5 **WP:** 5 **Break DC:** 14  
**Availability:** Specialized, military **Era:** ☉ ☾ ☽  
**Special:** This weapon fires 25 shots before needing to be reloaded. It uses a special ammunition canister (cost 100). This weapon fires a maximum of five range increments instead of the normal ten.

A larger version of the C-22 flame carbine, the CR-24 is more of a military weapon, though it sees use in the Corporate Sector alongside the C-22. It is effective against infantry and in clearing out opponents from well-secured locations such as bunkers and buildings. The Czerka model, called the CZ-24 Flamemaster, is identical in performance to the CR-24.

#### Merr-Sonn Model CR-28/Czerka CZ-28 Flamestrike Flame Cannon

**Weapon Type:** Flame projector **Cost:** 2,500  
**Proficiency Group:** Heavy weapons **Critical:** 19–20  
**Damage:** 6d6 **Weight:** 25 kg  
**Range Increment:** 4 m **Type:** Energy  
**Fort DC:** — **Size:** Large  
**Multifire/Autofire:** — **Break DC:** 17  
**Hardness:** 5 **WP:** 10 **Era:** ☉ ☾ ☽  
**Availability:** Specialized, military  
**Special:** This weapon fires 50 shots before needing to be reloaded. It uses a special ammunition canister (cost 200). This weapon fires a maximum of five range increments instead of the normal ten.

The heaviest of flamers, the CR-28 may be fired from either a tripod stand or a vehicle mount. Primarily a military weapon, the heavy flamer needs to be fired from a stable, unmoving platform. The fuel canister is either mounted on the weapon platform or carried in hand and set up next to the weapon. The Czerka model is called the CZ-28 Flamestrike.

### Sonic Weapons

Sonic weapons have become increasingly common, particularly among security forces and local law authorities that prefer capturing opponents unharmed rather than injuring or killing them. Sonic weapons make use of a high-intensity sound to damage or daze their opponents. Most have both normal damage and daze settings; the latter reduces an aggressive opponent's effectiveness.

A target hit by a sonic weapon set on daze must make a Fortitude saving throw (DC varies by weapon) or be dazed for 1d4+1 rounds (see the Character Condition Summary in Chapter Twelve of the *Star Wars Roleplaying Game*). A successful save indicates no damage or other ill effects.

Using sonic weapons effectively requires the Exotic Weapon Proficiency (sonic weapons) feat. However, once an individual has this proficiency, he or she may use any sonic weapon.

Sonic weapons cannot be used in multifire or autofire mode.

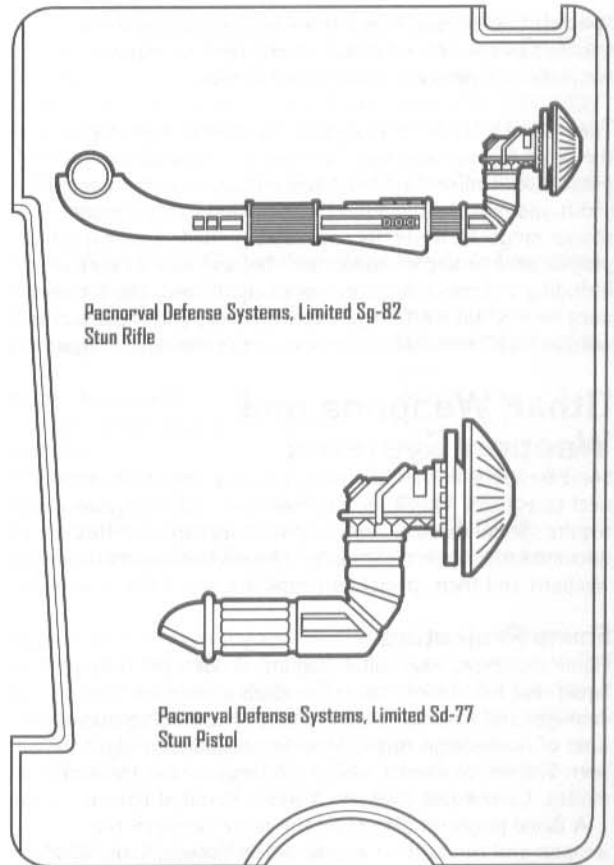

Pacnorval Defense Systems, Limited Sg-82  
Stun Rifle

Pacnorval Defense Systems, Limited Sd-77  
Stun Pistol

#### Pacnorval Defense Systems, Limited Sd-77 Sonic Pistol

**Weapon Type:** Sonic weapon **Cost:** 1,000  
**Proficiency Group:** Exotic (sonic weapons) **Critical:** 20  
**Damage:** 3d6 **Weight:** 1 kg  
**Range Increment:** 2 m **Type:** Special (sonic)  
**Fort DC:** 14 (daze) **Size:** Small  
**Multifire/Autofire:** — **Break DC:** 12  
**Hardness:** 5 **WP:** 2 **Era:** ☾ ☽  
**Availability:** Common, licensed  
**Special:** This weapon fires 40 shots before needing to be reloaded. It uses a standard power pack. This weapon fires a maximum of three range increments instead of the normal ten.

The small, handheld Sd-77 has a nontraditional design, looking more like a diagnostic tool than a real weapon. The weapon's oversized muzzle is flared to prevent the high-intensity blast of sound from affecting the wielder. Its distinctive look makes the Sd-77 a favorite of private security personnel, who don't want their weapons to be mistaken for blasters.

#### Pacnorval Defense Systems, Limited Sg-82 Sonic Rifle

**Weapon Type:** Sonic weapon **Cost:** 2,000  
**Proficiency Group:** Exotic (sonic weapons) **Critical:** 20  
**Damage:** 3d8 **Weight:** 4 kg  
**Range Increment:** 4 m **Type:** Special (sonic)  
**Fort DC:** 16 (daze) **Size:** Medium-size  
**Multifire/Autofire:** — **Break DC:** 17  
**Hardness:** 5 **WP:** 5 **Era:** ☾ ☽  
**Availability:** Common, restricted

**Special:** This weapon fires 20 shots before needing to be reloaded. It uses a standard power pack. This weapon fires a maximum of three range increments instead of the normal ten. The butt of the rifle may be used as a stun baton (see Chapter Seven of the *Star Wars Roleplaying Game*). The user may use either its stun baton function (a melee attack) or its sonic weapon function (a ranged attack) in a given round, but cannot make attacks of both types in the same round.

The Pacnorval Sg-82 is an evolution and expansion of the Sd-77, and it shares with that pistol its distinctive form.

### Pacnorval Defense Systems, Limited Sil-50 Sonic Pistol

**Weapon Type:** Sonic weapon

**Proficiency Group:** Exotic (sonic weapons) **Cost:** 3,000

**Damage:** —

**Critical:** —

**Range Increment:** 2 m

**Weight:** 1 kg

**Fort DC:** 18 (daze)

**Type:** Special

**Multifire/Autofire:** —

**Size:** Small

**Hardness:** 5

**WP:** 2

**Break DC:** 14

**Availability:** Common, licensed

**Era:** ☉

**Special:** This weapon fires 50 shots before needing to be reloaded. It uses a standard power pack. This weapon fires a maximum of five range increments instead of the normal ten.

With its traditional pistol-grip design, the Sil-50 is the most "normal-looking" of the Pacnorval sonic weapons. It is also the most highly advanced. The Sil-50 is designed to only to daze, and does so even more effectively than the Sg-82 sonic rifle. It does not deal normal damage.

### Species-Specific Ranged Weapons

Some ranged weapons are manufactured by or preferred by members of specific species, owing to their species' natural evolution or design philosophies. The weapons described below are connected with specific species; they may occasionally be made available to members of other species.

#### Rheshalva Interstellar Armaments Rodian Repulsor Throwing-Razor

**Weapon Type:** Repulsor throwing-razor

**Proficiency Group:** Exotic  
(repulsor throwing-razor)

**Cost:** 3,000 (pair)

**Damage:** 2d6

**Critical:** 19–20

**Range Increment:** 10 m

**Weight:** 1 kg

**Fort DC:** —

**Type:** Slashing

**Multifire/Autofire:** —

**Size:** Small

**Hardness:** 5

**WP:** 3

**Break DC:** 13

**Availability:** Rare, licensed

**Era:** ☉ ☽ ☿

**Special:** This weapon may be thrown up to ten range increments instead of the usual four.

A beautiful and deadly marriage of craftsmanship and technology, the Rodian repulsor throwing-razor is a thrown weapon with a built-in repulsor system to extend its natural range. In addition, a homing beacon in the finely balanced razor allows it to return to its thrower in the round after it is thrown. The razor returns blunt side first at a moderate velocity, homing in on a transponder worn on the user's belt and hovering nearby until reclaimed by the thrower. If it is prevented from returning, the throwing-razor emits a chirping sound. It may be wielded as a melee weapon, but it is treated as an unpowered knife for damage. This weapon is sold in matched pairs.

**OPTIONAL SPECIES CHIPS**

As an optional rule, Pacnorval sonic weapons may need to be tailored to specific species, increasing the effectiveness of these weapons against members of that species but having no effect against other species. A target-chipped species has the DC of its Fortitude save increased by +2. A nontargeted species is not affected by the weapon.

In the Rebellion era, the only chip available is for Humans (it also affects near-Human species). In The New Jedi Order era, chips exist for Humans, Rodians, Wookiees, and Sullustans, along with a handful of other species.

Species chips cost 100 credits each. Inserting or changing a chip is a full-round action.

#### Squib Tensor Rifle

**Weapon Type:** Tensor rifle

**Proficiency Group:** Exotic (tensor rifle) **Cost:** 10,000

**Damage:** 3d8

**Critical:** 20 and special

**Range Increment:** 20 m

**Weight:** 7.2 kg

**Fort DC:** —

**Type:** Energy

**Multifire/Autofire:** —

**Size:** Medium-size

**Hardness:** 5

**WP:** 5

**Break DC:** 13

**Availability:** Rare, restricted

**Era:** ☽ ☿

**Special:** This weapon fires 15 shots before needing to be reloaded. It uses a standard power pack. Each time this

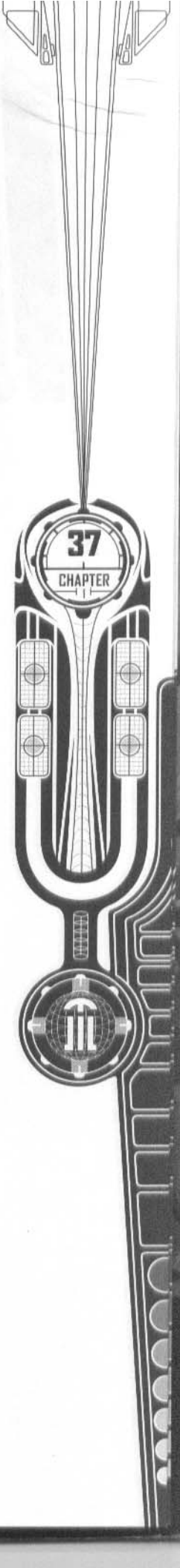
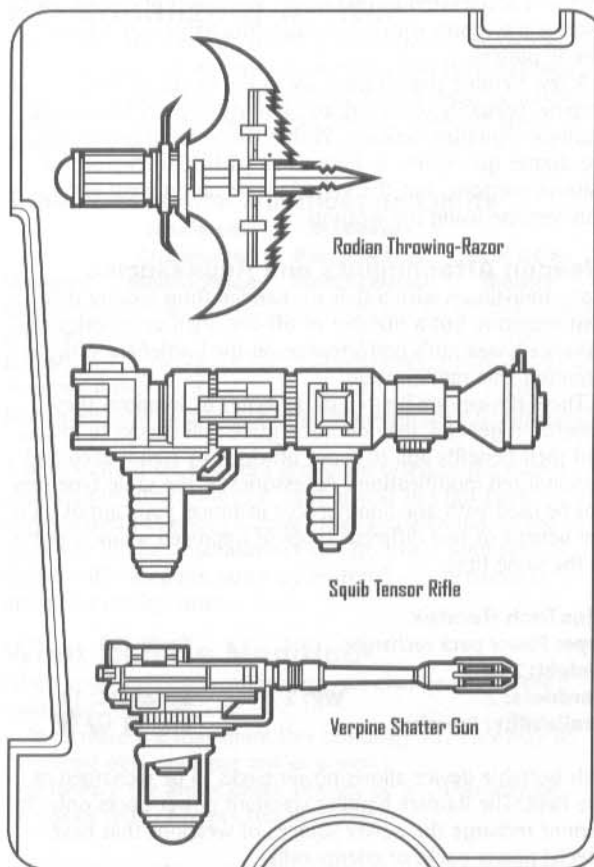

weapon hits the same target with consecutive shots, its threat range improves by 1. This weapon cannot be used in multifire or autofire mode.

The mammalian Squibs have incorporated their knowledge of tractor beam technology into their tensor rifle. The squib rifle besieges its target with waves of tractor beams, creating cell disruption. Multiple hits against the same target increase the weapon's effectiveness, potentially dealing massive amounts of damage.

A tensor rifle's beam is invisible, but the discharge is very loud.

### Verpine Shatter Gun

**Weapon Type:** Magnetic accelerator weapon  
**Proficiency Group:** Exotic **Cost:** 15,000  
(magnetic accelerator weapon)  
**Damage:** 6d6 **Critical:** 20  
**Range Increment:** 20 m **Weight:** 1 kg  
**Fort DC:** — **Type:** Energy  
**Multifire/Autofire:** — **Size:** Small  
**Hardness:** 3 **WP:** 2 **Break DC:** 10  
**Availability:** Rare, illegal **Era:** Ⓢ

**Special:** This weapon fires 50 shots before needing to be reloaded. It uses special ammunition (cost 500 per 50 shots). This weapon is extremely fragile; any sudden drop or injury requires a check against its break DC.

Created by the insectoid Verpine, the shatter gun is a unique, expensive, and extremely fragile item. It fires a stream of small metallic projectiles suspended in a magnetic field and accelerated to just under the speed of sound. The result is a weapon with a soundless discharge but a high kinetic punch.

A few Verpine shatter guns are in the hands of non-Verpine, primarily collectors and bounty hunters looking for a unique signature weapon. Within the Verpine community, the shatter gun seems to have some particular religious or cultural overtone, but the Verpine have no problem with non-Verpine using the weapon.

### Weapon Attachments and Accessories

Many individuals with a flair for handcrafting modify their own weapons, but a number of off-the-shelf accessories can enhance a weapon's performance on the battlefield without requiring true modification.

These devices are limited in the types of weapons they benefit. In general, they do not require skill checks to install, and their benefits add to those provided by customized and personalized modifications. Accessories of the same type may not be used with one another—for instance, you cannot gain the benefit of two different types of improved weapon sights at the same time.

#### BlasTech Ramtek

**Type:** Power pack recharger **Cost:** 750  
**Weight:** 2 kg  
**Hardness:** 2 **WP:** 2 **Break DC:** 14  
**Availability:** Prevalent **Era:** Ⓢ Ⓣ Ⓤ

This portable device allows power packs to be recharged in the field. The Ramtek handles standard power packs only; it cannot recharge the power sources of weapons that have special power packs or energy cells.

Inserting a power pack into the device is a move action. The Ramtek can recharge up to six power packs at a time; the process of recharging takes 2 minutes. Up to 30 power packs may be recharged before the recharger itself needs to have its power supply replenished from a stationary power source.

The BlasTech Ramtek is one of three portable rechargers on the market, all of which are virtually identical. The other two are the CapTech Stealthpak and the Power Products Ultrapaq.

#### Merr-Sonn NonSonic Silencer/Flash Suppressor

**Type:** Slugthrower silencer **Cost:** 900  
**Weight:** 0.25 kg  
**Hardness:** 2 **WP:** 2 **Break DC:** 14  
**Availability:** Common **Era:** Ⓢ Ⓣ Ⓤ  
**Special:** This device negates the sound and light emissions from a slugthrower when the weapon is fired. It reduces the maximum range of the weapon by two range increments.

Custom designed to fit over the muzzle of a slugthrower pistol or rifle, this device reduces the noise and flash of firing. NonSonic Silencers come in many varieties, each made for a particular model of slugthrower. A NonSonic Silencer made for one model generally cannot be fitted to other models.

Some slugthrowers, such the Field Sports Air Pistol (see Slugthrower Pistols, earlier in this chapter), are already silent and do not benefit from this device.

#### Merr-Sonn Targeter Ranging Scope

**Type:** Improved weapon sight **Cost:** 750  
**Weight:** 0.5 kg  
**Hardness:** 2 **WP:** 2 **Break DC:** 14  
**Availability:** Prevalent **Era:** Ⓢ Ⓣ Ⓤ  
**Special:** This device negates range penalties for the first two range increments. It does not extend the weapon's maximum range beyond ten range increments.

When mounted atop a blaster rifle, this scope reduces the effect of range. It does not give the weapon a greater range, but lessens the penalty for hitting a distant target.

#### Novaless Soni-Optics Target Imager

**Type:** Improved weapon sight **Cost:** 3,000  
**Weight:** 0.5 kg  
**Hardness:** 2 **WP:** 2 **Break DC:** 14  
**Availability:** Prevalent **Era:** Ⓢ Ⓣ Ⓤ  
**Special:** This device grants a +1 bonus on attack rolls with blaster rifles against targets within 50 meters. Blasters gain this benefit only for the first shot fired in each round. This device negates Defense bonuses because of vegetation, smoke, darkness, and other forms of concealment.

A computerized scope, the Soni-Optics Imager uses ultrasonic beam emitters to sight on the target, which return information in the form of different wave patterns that create a composite sonic image. This form of sighting allows the user to ignore certain types of cover and concealment and grants a bonus on the first attack of each round. The imager may be fitted easily to any blaster rifle.



The best armor in the galaxy is skill, luck, and experience. Not everyone is gifted with these attributes, so physical armor is commonly used as well. Often this ranges from simple combat suits that may reduce damage from the particularly lucky (or particularly accurate) blaster bolt, to fully powered armor bristling with abilities and potential lethality.

Armor trades a modicum of protection in exchange for a reduction in ability. The protection is chiefly in the form of damage reduction, which reduces the amount of wound damage (though not vitality damage) to the wearer. The reduction in ability takes the form of a limit on the wearer's maximum Dexterity bonus, armor check penalties to some skills, and possibly a reduction of speed.

Armors are described according to general type—light, medium, and heavy body armors, along with powered armor (which often grants the wearer features beyond mere protection). This chapter also covers other types of protective gear that are not combat armor in the traditional sense, but that protect the wearer from dangers other than the conventional damage.

Each armor is described by a number of attributes, as follows.

**Armor Type:** The general type of armor: light, medium, heavy, or powered. A fifth category includes nonarmor protective gear.

**Proficiency Group:** The armor proficiency feat required to effectively use this type of armor.

**Cost:** The normal cost of the armor, in credits.

**Damage Reduction:** The amount of damage reduced from any wound damage dealt to the user. Some armors only protect against specific types of damage; when that's the case, the damage type is also given.

**Maximum Dex Bonus:** The maximum Dexterity bonus you can apply to your Defense when wearing this armor.

**Armor Check Penalty:** If you do not have the appropriate armor proficiency feat, you apply this penalty on all skill checks that have Strength or Dexterity as the key ability, as well as on attack rolls. Even with the appropriate armor proficiency feat, the armor check penalty applies to the following skills: Climb, Disable Device, Escape Artist, Hide, Jump, Move Silently, Sleight of Hand, Swim, and Tumble. There may be an additional penalty for a specific model of armor if you are not proficient in its use.

**Speed:** Heavier suits of armor can slow you down. Two numbers, separated by a slash, show the maximum speed that a Medium-size individual (with a normal base speed of 10 meters) and a Small individual (with a normal base speed of 6 meters) can move when wearing this armor. For

example, "8 m/4 m" indicates that a Medium-size individual can move at a speed of 8 meters while wearing this armor, while a Small wearer's speed is 4 meters. Certain types of powered armor provide additional movement rates for specific modes of movement (such as flight).

**Weight:** The weight of the armor. Armor fitted for Small characters weighs half of this figure. Armor fitted for Large creatures weighs twice this figure.

**Availability:** How available the item is. See Equipment Availability in the introduction for definitions of the various availability ratings.

**Era:** The eras of play in which the item is usually available. See the introduction for more information.

**Special:** Any special rules for this armor type.

## Customizing and Personalizing Armor

Armor may be customized and personalized in much the same way as weapons (see Customizing and Personalizing Weapons, at the start of Chapter 1). The number of modifications that may be made to a particular piece of armor is determined by its type:

**Table 2-1: Armor Modification Limits**

Weapon	Maximum	Maximum	Skill DC to
	Customized	Personalized	
Light	1	1	5
Medium	1	2	10
Heavy	2	3	15
Powered armor	2	3	20
Nonarmor	0	1 (with GM's permission)	20+

A personalized set of armor is custom fitted to the owner and will not fit anyone else. (Armor that has not been personalized has enough "give" that an individual of the same size as the original owner can fit into it normally.) Unlike with weapons, you may customize or personalize armor for use by others.

### What Can Be Modified

When you modify a weapon, you can change one of the following attributes.

- ⊕ Increase the maximum Dex bonus by +1. This may be done only once per suit of armor.
- ⊖ Reduce the armor check penalty by +1. This may be done only once per suit of armor.

- ⊕ Increase the wearer's speed by 2 meters (to the maximum of his or her normal base speed). This may be done only once per suit of armor.
- ⊕ Reduce the armor's weight by half or by 10 kilograms, whichever is less. This may be done only once per suit of armor.
- ⊕ Install an additional weapon. This option applies only to heavy and powered armors. The weapon is purchased separately. The weapon can be Medium-size or Large, and may be a melee weapon or a ranged weapon. A weapon built into a suit of armor cannot be dropped or disarmed. It may be attacked and damaged normally. In order to attach a weapon to a suit of armor, you must have the appropriate Craft skill for that weapon type. Each weapon counts as a separate modification.
- ⊕ Install an additional piece of equipment. This option applies only to medium, heavy, and powered armors. Medpacs, comlinks, and sensors are common types of equipment installed in armor. Each piece of equipment counts as a separate modification.

You cannot affect the damage reduction of a suit of armor through customization or personalization. Armor's damage reduction can be improved only by having a tech specialist make the armor into a mastercraft item. You can repair damage to armor by using the Repair skill.

## Making the Modification

The rules for modifying armor are identical to those for modifying weapons. See Making the Modification, at the start of Chapter 1.

## Other Rules Concerning Armor

**Wearing Multiple Types of Armor:** Some armor may conceivably be worn with other armor (such as a climbsuit underneath a stormtrooper's outfit). As a rule of thumb, only the protection and abilities of the outermost type of armor benefit the wearer. For instance, a climbsuit does not provide any climbing benefit if it's worn inside stormtrooper armor. Exceptions are noted in the individual descriptions.

**Size:** The given armor prices assume armor built for a Medium-size creature. Generally, armor for a Small creature costs 10% less, while armor for a Large creature costs 10% more than the given price. Most armor is not available for creatures smaller than Small or bigger than Large; when it is, it's often custom-made and much more expensive. Any nonpersonalized set of armor used by one individual may usually be worn by a character of the same size and species.

**Armor for Non-Human Species:** The given armor prices are for armor that fits Human characters and those of similar body size and shape. Armor for species of other shapes costs 150% of the given price, unless obtained from a manufacturer of that species. Armor made by such manufacturers to fit Humans or similar species also costs 150% of the given price.

**Damaging Armor:** Armor does not provide damage reduction on attacks against itself. If armor is attacked as an object (when it's not being worn), it is treated as an object of the appropriate size and material.

## Light Armor and Protective Suits

Light armor provides the least protection of the armor types, generally having damage reduction of 1 to 3. It is usually made of woven and strengthened cloth or plastics, sometimes of leather, and is designed to be supple and nonrestrictive. Common types of light armor include flight suits, blast vests, and the ubiquitous combat jumpsuit.

Light armor often includes a helmet of some type. Usually light armor does not seal to protect the wearer from environmental hazards. One can generally get into or out of a suit of light armor as a move action or attack action.

Light armor is generally the most socially acceptable type of armor. In the wilder regions of space, no one takes a second look at an individual sauntering into a cantina wearing a blast helmet and vest or a padded flight suit.

### Ayelixa/Krongbing Textiles Climbsuit

**Armor Type:** Light armor

**Cost:** 600

**Maximum Dex Bonus:** +5

**Speed:** 10 m/6 m

**Availability:** Common

**Proficiency Group:** Light

**Damage Reduction:** 0

**Armor Check Penalty:** 0

**Weight:** 2.5 kg

**Era:** 

The climbsuit is a special form of armor that assists the wearer in climbing, especially when traveling along smooth modern materials. The suit consists of knee and elbow pads plus gloves covered in FrictionGrip, a substance designed to stick to smooth surfaces. It also includes a high-impact helmet and an equipment harness.

A character wearing a climbsuit gains a +3 equipment bonus on all Climb checks. It also becomes possible to climb a perfectly smooth, flat surface with a Climb check (DC 30). The suit makes falling much less likely—a character has to fail a Climb check by 10, rather than 5, to fall.

The features of a climbsuit (the pieces covered in FrictionGrip) can be added to a set of nonpowered armor. Armor modified in this way provides only a +2 equipment bonus on Climb checks (instead of the normal +3), but otherwise functions as a normal climbsuit. Other functions of the modified armor (such as its damage reduction or armor check penalty) remain unchanged. To make this modification, add the price of a climbsuit to all other costs involved in the modification.

### Ayelixa/Krongbing Textiles Shadowsuit

**Armor Type:** Light armor

**Cost:** 600

**Maximum Dex Bonus:** +6

**Speed:** 10 m/6 m

**Availability:** Common, military

**Proficiency Group:** Light

**Damage Reduction:** 0

**Armor Check Penalty:** -1

**Weight:** 3 kg

**Era:** 

A shadowsuit is a flat black body stocking that covers everything but the wearer's eyes (which are normally concealed behind goggles of some kind). It is woven from shadow silk, a soft material that absorbs both light and sound, with additional sound-dampening pads at the hands and feet. All the stealth functions of a shadowsuit are passive; it uses no electronics that might be detected by sensors.

A character wearing a shadowsuit gains a +10 equipment bonus on Hide and Move Silently checks. This benefit is negated if the individual is wearing any other type of armor underneath the suit.

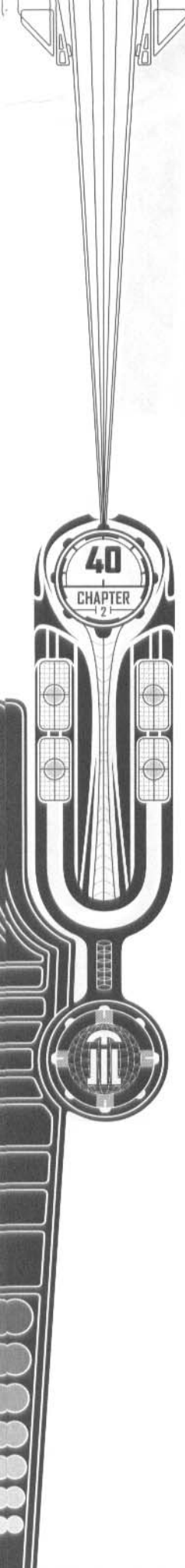



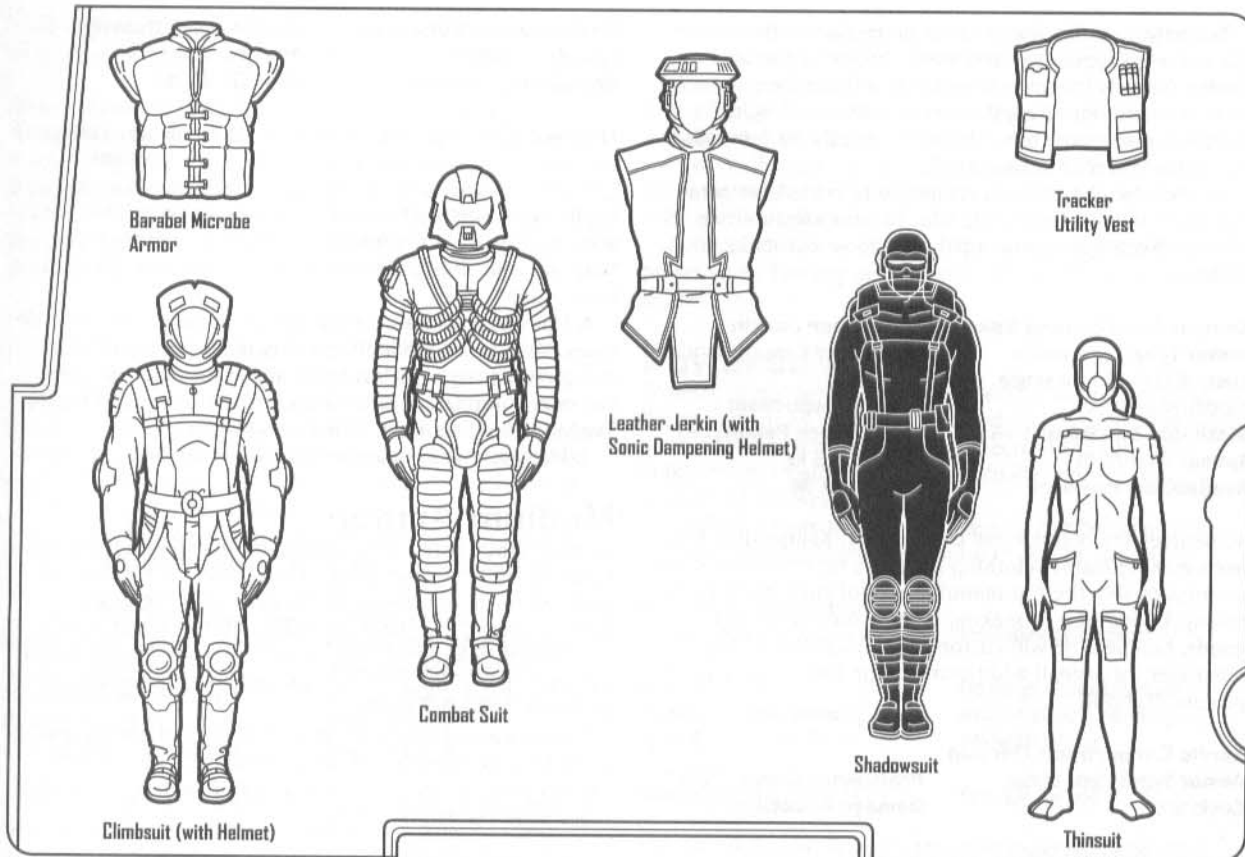

#### Ayelixa/Krongbing Textiles Tracker Utility Vest

**Armor Type:** Light armor

**Cost:** 300

**Maximum Dex Bonus:** +6

**Speed:** 10 m/6 m

**Availability:** Common

**Proficiency Group:** Light

**Damage Reduction:** 1

**Armor Check Penalty:** -1

**Weight:** 0.5 kg

**Era:**

The tracker utility vest is a light, sleeveless garment designed to allow hunters and guides to carry numerous small items in a comfortable and convenient manner. It is constructed of a tough leathery material created from bantha hide, and it is resistant to tears, stains and corrosion.

The vest can carry up to twenty-four objects of 1 kilogram or less in weight, each in one of a series of pockets, pouches and straps. Because the weight of these items is evenly distributed, their total weight is halved for purposes of determining the character's encumbrance.

#### Ayelixa/Krongbing Textiles Tuff1 Combat Suit

**Armor Type:** Light armor

**Cost:** 500

**Maximum Dex Bonus:** +6

**Speed:** 10 m/6 m

**Availability:** Common

**Proficiency Group:** Light

**Damage Reduction:** 1

**Armor Check Penalty:** -1

**Weight:** 2 kg

**Era:**

The Tuff1 combat suit is a light protection suit designed to be worn under loose civilian clothing. It consists of a tight body suit with padded armor sections at the chest, elbows, and knees. The material dries quickly and breathes well, making it easy to wear for long periods of time. The suit can be equipped with rings and straps for attaching equipment securely in easy-to-reach places.

If worn by itself, the combat suit provides only minimal protection. It is often combined with other armor, most often a blast helmet and vest. In such use it serves as a backup; it doesn't provide any additional protection, but is there in case the outer armor becomes damaged and has to be discarded.

#### Creshaldyne Industries Barabel Microbe Armor

**Armor Type:** Light armor

**Proficiency Group:** Light

**Cost:** 15,000

**Damage Reduction:** 3 (against energy weapons only)

**Maximum Dex Bonus:** +4

**Armor Check Penalty:** -2

**Speed:** 10 m/6 m

**Weight:** 3 kg

**Availability:** Specialized

**Era:**

**Special:** Each time the wearer takes wound damage from an energy weapon attack, the damage reduction provided by this armor increases by 1 (to a maximum of 5). This extra damage reduction wears off after 15 minutes. If this armor is exposed to a temperature lower than 0° C for 15 minutes, its damage reduction is permanently reduced to 0.

The Barabel microbe armor from Creshaldyne Industries looks like a sleeveless vest covered in sealed pockets of soft material. In fact, the pockets are filled with packets of saline solution rich with millions of microorganisms. These microbes feed on various forms of radiation and energy emissions, including those generated by blaster fire. When exposed to blaster fire, the microbes absorb the attack as food, their numbers swelling within the saline (though built-in environmental controls prevent them from ever exceeding the vest's capacity).

Not only does this feature offer protection to the wearer, but as the microbes' numbers swell, the protection against blasters actually increases temporarily. Attacks by weapons other than blasters affect the vest as normal, using its current damage reduction. This increase lasts for 6 rounds before the vest returns to normal.

Barabel microbe armor is vulnerable to cold. A temperature lower than 0° Centigrade kills the microorganisms in 15 minutes. Recharging a damaged or dead vest costs 12,000 credits.

#### Kamperdine Clothing Specialists Leather Jerkin

**Armor Type:** Light armor  
**Cost:** 300 (+150 for single modification)

**Maximum Dex Bonus:** +6

**Speed:** 10 m/6 m

**Availability:** Prevalent

**Proficiency Group:** Light

**Damage Reduction:** 1

**Armor Check Penalty:** -1

**Weight:** 1.5 kg

**Era:**   

Sometimes the oldest ideas are the best. Kamperdine has been making leather clothing products for centuries and is unquestionably the top manufacturer of such items in the galaxy. In addition to making highest quality leather goods, Kamperdine will custom-fit the apparel to the purchaser for a small additional charge (this counts as one personalization).

#### Karflo Corporation Thinsuit

**Armor Type:** Light armor

**Cost:** 900

**Proficiency Group:** Light

**Damage Reduction:** 0

**Maximum Dex Bonus:** +6

**Speed:** 10 m/6 m

**Availability:** Common

**Armor Check Penalty:** -1

**Weight:** 1 kg

**Era:**   

The Karflo Thinsuit is designed to act as insulation against extremes of pressure and temperature. It is a skintight garment that covers the entire body, made of a thin but highly insulating material with tiny heaters and coolers, allowing it to keep the wearer comfortable in extremes of heat and cold. The suit comes with a breather mask with 1 hour of internal air.

A Thinsuit provides a +4 equipment bonus on all Fortitude saves made to resist the effects of extreme heat and cold, and prevents any penalties being added for previous saves. For more information on environmental effects, see Chapter Twelve of the *Star Wars Roleplaying Game*.

A Thinsuit may be worn beneath other armors.

## Medium Armor

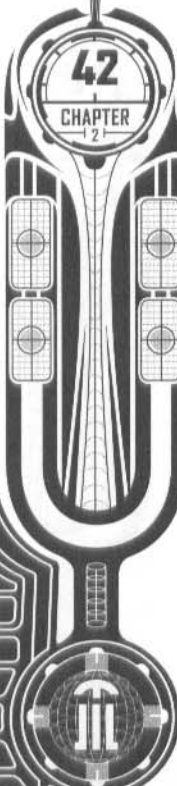
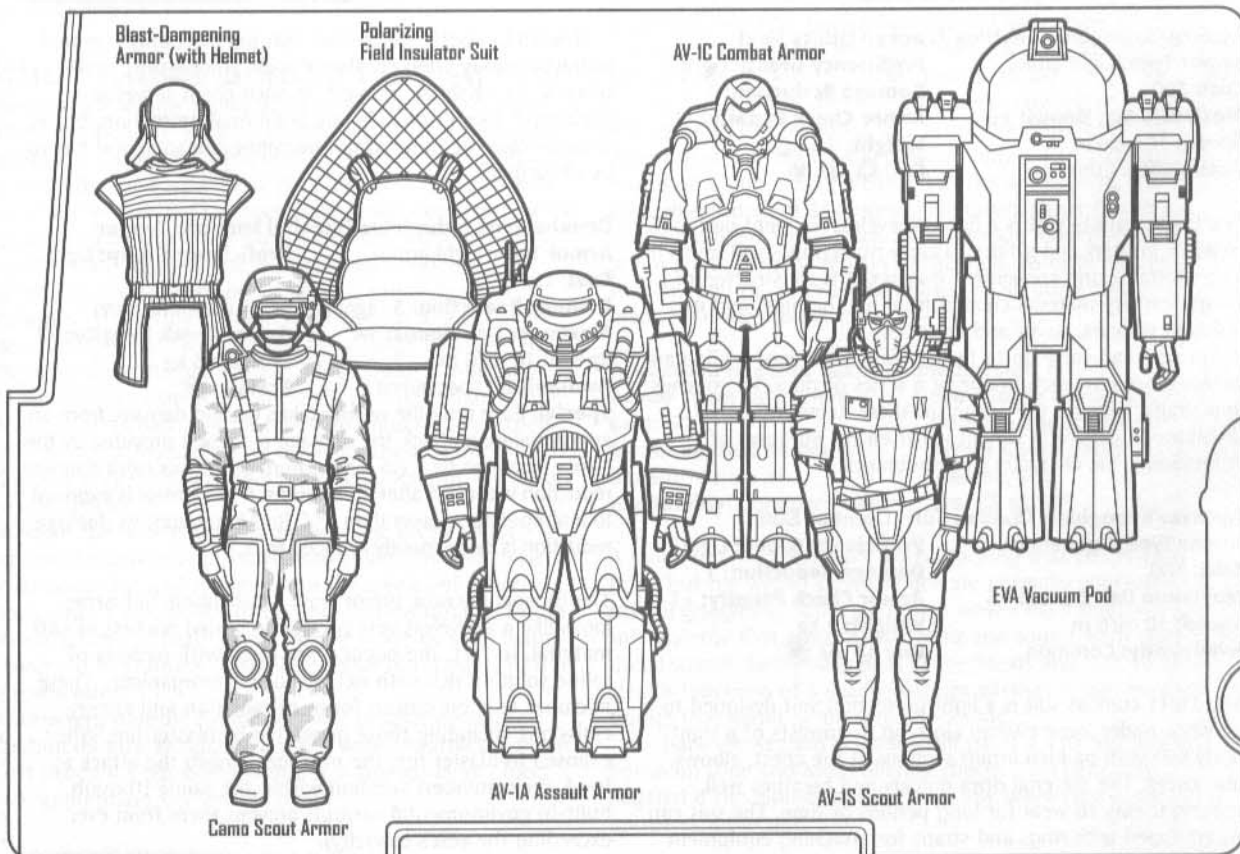

Medium armor offers more protection than light armor, and backs up the protective value of the fabric itself with small plates of metal or ceramic. In the more effective types of medium armor, the plates are visible on the outside, where they provide additional protection to the wearer's joints and soft body parts—but this extra protection comes at the cost of reduced maneuverability.

Medium armor often includes a helmet that can be sealed to protect the individual from environmental effects. One can generally get into or out of a suit of medium armor as a move action or attack action.



An individual in medium armor tends to attract attention in most starport bars and major metropolitan areas.



#### Crashaldyne Industries Blast-Dampening Armor

**Armor Type:** Medium armor    **Proficiency Group:** Medium  
**Cost:** 6,000  
**Damage Reduction:** 2 or 5 against blaster attacks  
**Maximum Dex Bonus:** +2    **Armor Check Penalty:** -2  
**Speed:** 8 m/4 m    **Weight:** 4 kg  
**Availability:** Common    **Era:**   

Blast-dampening armor is popular among many security forces and bodyguards, because it is lightweight and flexible but still offers good protection against blasters—the most common weapon in the galaxy. It is formed of a rubbery insulative material with thousands of tiny reflecting crystals suspended within it. The crystals protect the wearer against the tremendous heat of a blaster bolt and diffuse much of the coherent light comprising the bolt.

Blast-dampening armor is usually worn with an open-faced helmet, similar to the helmet used with a blast vest.

#### Crashaldyne Industries Camo Scout Armor

**Armor Type:** Medium armor    **Proficiency Group:** Medium  
**Cost:** 6,000    **Damage Reduction:** 4  
**Maximum Dex Bonus:** +3    **Armor Check Penalty:** -3  
**Speed:** 8 m/4 m    **Weight:** 6 kg  
**Availability:** Specialized    **Era:**   



Camo scout armor is designed to protect the wearer from both attack and discovery. It consists of a series of hard plates over a fabric body suit. Embedded within the armor are miniature photoreactive fibers that allow the armor to absorb light and change color to match its surroundings. As a result, the armor provides a +10 circumstance bonus on Hide checks, regardless of terrain.

## Heavy Armor

Heavy armor is the most protective and weightiest of armor types, and generally consists of visible solid plates of reinforced durasteel and ceramic mixtures that enclose the body to provide maximum protection. Heavy armor is almost always sealed against environmental hazards. One can generally get into or out of a suit of heavy armor as a full-round action.

Heavy armor is rarely worn casually; it is generally only seen when specific circumstances call for its use.

#### VargeCorp Polarizing Field Insulator Suit

**Armor Type:** Heavy armor    **Proficiency Group:** Heavy  
**Cost:** 3,000    **Damage Reduction:** 2  
**Maximum Dex Bonus:** +1    **Armor Check Penalty:** -6  
**Speed:** 6 m/2 m    **Weight:** 30 kg  
**Availability:** Common    **Era:**   

Large and bulky, the polarizing field insulator suit is most often used by mechanics and technicians who face a risk of exposure to powerful energy discharges as part of their work. This armor looks like a giant shell worn on the back, combined with a thick, armored tunic covering the torso, pelvis, and arms. Within the shell is a powerful generator that creates an insulating field around the wearer.

As a result, the wearer and everything within 4 meters of the field insulator receives electricity/ion energy resistance 25 when the generator is active. (For the wearer, this protection is in addition to the suit's damage reduction.) The suit provides no protection from other forms of energy, such as cold or fire/blaster energy. In addition to the energy resistance, the field effect also protects droids from the stun setting effects of ion weapons.



A generator can operate for 30 minutes on a standard power pack. Turning the generator on or off is a move action.

## Powered Armor

Powered armor contains internal mechanisms to duplicate the movement of the body protected within. Sometimes such mechanisms merely diminish the effects of the otherwise bulky armor; in other cases they actually enhance the strength of the wearer.

Powered armors tend to be extremely cumbersome, and may require more than a full round to don or remove.

#### GTU AV-1A Assault Armor

**Armor Type:** Powered armor    **Proficiency Group:**  
Powered  
**Cost:** 50,000    **Damage Reduction:** 8  
**Maximum Dex Bonus:** +0    **Armor Check Penalty:** -7  
**Speed:** 8 m/4 m, fly 10 m  
(poor)    **Weight:** 60 kg  
**Availability:** Rare, military    **Era:**   

The AV-1A Assault Armor is the most expensive, and most advanced, suit of powered armor available. It is considered a military weapon, and its ownership is highly regulated on most worlds. It is designed to be the ultimate suit for combat, completely covering the wearer and protecting him from weapon fire and hostile atmospheres, and even healing him in case of injury. It is almost a small vehicle, made of a central shell that encompasses the armor's power packs and much of its internal circuitry, with armored plates fully covering the operator's limbs and a massive helmet protecting his or her head.

The armor can operate for 12 hours on a set of six standard power packs, after which time it ceases all function; the operator suffers penalties as if he lacked the Armor Proficiency (powered) feat, and can only take a single move action or attack action each round. It takes 15 minutes to get into this suit of armor and 6 full rounds to get out.

The AV-1A has the following features.

**Strength Augmentation:** The powered servos give the operator a +6 equipment bonus to Strength. If the operator does not have the Armor Proficiency (powered) feat, not only does this bonus not apply, but the operator suffers a -6 penalty to Strength and Dexterity while in the suit.

**Life Support:** The suit provides full life support for 12 hours, with an internal air supply and protection against the most extreme environments, including deep space.

**Computerized Targeting:** The suit has mounts to carry up to three ranged weapons of size Large or smaller, as built-in parts of the armor. These weapons receive a +2 equipment bonus on all attack rolls. Additional weapons may be carried and used by the suit's wearer, but are not attached to the computer targeting system and do not gain

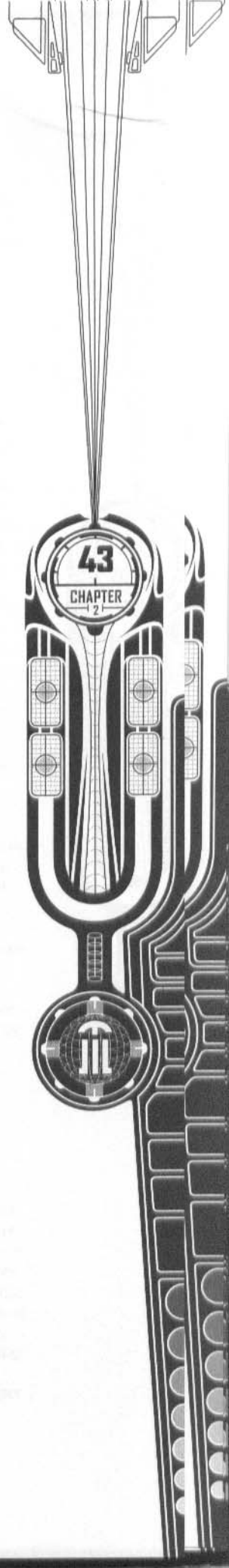

the attack bonus. The wearer may use only one suit-mounted weapon per round.

**Repulsorlift:** The AV-1A is equipped with a repulsorlift, giving it the ability to fly at a speed of 10 meters with poor maneuverability. The repulsorlift has an operational altitude of low (about 1,000 meters), though in a zero-g environment, maneuvering thrusters take over and allow flight capability.

**Sensors:** The suit grants its operator low-light vision and darkvision out to 20 meters and provides the benefit of a pair of electrobinoculars, reducing the wearer's penalty on Spot checks to -1 for every 20 meters.

**Medpac:** The suit includes all the needed chemicals and materials to act as an onboard medpac for its wearer. The medpac can be triggered by the suit's operator as a move action or attack action, and it activates automatically if the operator falls unconscious as a result of injury. The medpac device is a one-shot function, and the materials used must be replaced after use (cost 200).

**Comlink:** The armor's built-in comlink has a range of 100 kilometers and can send and receive encrypted messages.

**Powerlamp:** The armor includes a powerful lamp able to create a beam of light up to 100 meters long and 50 meters wide.

**Ejection System:** The suit's ejection system blows the suit apart and sends the operator up to 10 meters in a direction of his choice. Using the ejection system damages the armor, making it useless until it receives extensive repairs (cost 30,000 credits if performed at a shop, or 10,000 credits in materials and a Repair check DC 35 if owner attempts repair). Triggering the ejection system is a move action or attack action.

#### GTU AV-1C Combat Armor

**Armor Type:** Powered armor  
Powered

**Cost:** 25,000

**Maximum Dex Bonus:** +0

**Speed:** 8 m/4 m, fly 10 m  
(average)

**Availability:** Rare, military

**Proficiency Group:**

**Damage Reduction:** 6

**Armor Check Penalty:** -6

**Weight:** 25 kg

**Era:**   

The AV-1C is designed for combat and is popular with well-funded military units for use in front-line infantry actions. It is a fully enclosed suit of armor made of interlocking hard plates that provide complete coverage of the operator's body. It is powered by an extensive set of servomotors.

The armor can operate for 24 hours on a set of four standard power packs, after which time it ceases all function; the operator suffers penalties as if he lacked the Armor Proficiency (powered) feat. It takes 10 minutes to get into this suit of armor and 6 full rounds to get out.

The AV-1C has the following features.

**Strength Augmentation:** The powered servos give the operator a +4 equipment bonus to Strength. If the operator does not have the Armor Proficiency (powered) feat, not only does this bonus not apply, but the operator suffers a -4 penalty to Strength and Dexterity while in the armor.

**Life Support:** The suit provides full life support for 24 hours, with an internal air supply and protection against the most extreme environments, including vacuum.

**Computerized Targeting:** The suit has mounts to carry up to two ranged weapons of size Large or smaller, as built-in parts of the armor. These weapons receive a +2 equipment bonus on all attack rolls. Additional weapons may be carried and used by the suit's wearer, but are not attached to the computer targeting system and do not gain the attack bonus. The wearer may use only one suit-mounted weapon per round.

**Repulsorlift:** The AV-1C is equipped with a repulsorlift, giving it the ability to fly at a speed of 10 meters with average maneuverability. The repulsorlift has an operational altitude of low (about 1,000 meters).

**Sensors:** The suit grants its operator low-light vision and darkvision out to 20 meters and provides the benefit of a pair of electrobinoculars, reducing the wearer's penalty on Spot checks to -1 for every 20 meters.

**Comlink:** The armor's built-in comlink has a range of 50 kilometers and can send and receive encrypted messages.

**Powerlamp:** The armor includes a powerful lamp able to create a beam of light up to 100 meters long and 50 meters wide.

#### GTU AV-1S Scout Armor

**Armor Type:** Powered armor  
Powered

**Cost:** 15,000

**Maximum Dex Bonus:** +1

**Speed:** 8 m/4 m, fly 10 m  
(good)

**Availability:** Rare, military

**Proficiency Group:**

**Damage Reduction:** 4

**Armor Check Penalty:** -3

**Weight:** 18 kg

**Era:**   

The AV-1S is most useful for reconnaissance and search and rescue missions. It consists of a series of tight-fitting plates over a thick suit of flexible, airtight mesh, with the most important joints powered by tiny motors. It includes a form-fitting helmet.

The armor can operate for 36 hours on a set of three standard power packs, after which time it ceases all function; the operator suffers penalties as if he lacked the Armor Proficiency (powered) feat. It takes 5 minutes to get into this suit of armor and 6 full rounds to get out.

Unlike most powered armor, the AV-1S is not illegal on most worlds, though many planetary governments require background checks and licensing prior to purchase.

The AV-1S has the following features.

**Strength Augmentation:** The powered servos give the operator a +2 equipment bonus to Strength. If the operator does not have the Armor Proficiency (powered) feat, not only does this bonus not apply, but the operator suffers a -2 penalty to Strength and Dexterity while in the armor.

**Life Support:** The suit provides full life support for 36 hours, with an internal air supply and protection against the most extreme environments, including vacuum.

**Computerized Targeting:** The suit has mounts to carry up to two ranged weapons of size Large or smaller, as built-in parts of the armor. These weapons receive a +2 equipment bonus on all attack rolls. Additional weapons may be carried and used by the suit's wearer, but are not attached to the computer targeting system and do not gain the attack bonus. The wearer may use only one suit-mounted weapon per round.

**Repulsorlift:** The AV-1S is equipped with a repulsorlift, giving it the ability to fly at a speed of 10 meters with good

maneuverability. The repulsorlift has an operational altitude of low (about 1,000 meters).

**Sensors:** The suit grants its operator low-light vision and darkvision out to 20 meters and provides the benefit of a pair of electrobinoculars, reducing the wearer's penalty on Spot checks to -1 for every 20 meters.

**Comlink:** The armor's built-in comlink has a range of 50 kilometers and can send and receive encrypted messages.

**Powerlamp:** The armor includes a powerful lamp able to create a beam of light up to 100 meters long and 50 meters wide.

**Atmospheric Analyzer:** The AV-1S is equipped with a series of sensors designed to detect anything harmful within the surrounding atmosphere. The operator may make a Computer Use check (DC 15) to determine if the air is breathable and another check (DC 20) to identify individual poisons or diseases in an unsafe atmosphere.

#### Regallis Engineering EVA Vacuum Pod

**Armor Type:** Powered armor  
Powered

**Proficiency Group:**

**Cost:** 15,000

**Damage Reduction:** 3

**Maximum Dex Bonus:** +0

**Armor Check Penalty:** -6

**Speed:** 8 m/4 m, fly 10 m  
(average)

**Weight:** 35kg

**Availability:** Common

**Era:** ⚙️ ⚡️ ⚙️

The Regallis Engineering Extravehicular Activity (EVA) Pod is a suit of powered, droid-aided armor designed to allow the wearer to make emergency repairs to a starship in deep space—even one not experienced in the use of powered armor. The suit is a fully sealed system with life support and external thrusters (giving it a fly speed of 10 meters, but only in zero-g environments). It has motorized limbs, an external bay for storing repair materials, and a complete set of engineering tools built into the motorized arms.

The suit is controlled by a low-level droid brain, which handles all the complicated tasks of running the suit (matching velocities and trajectories, adjusting life support as needed, and so on). Despite this assistance, the wearer still needs the Armor Proficiency (powered) feat to operate the armor effectively. Individuals without the Armor Proficiency (powered) feat cannot use the equipment bonuses provided by the EVA pod's features (see below) but take no additional penalties on skill checks as a result of their lack of proficiency.

It takes 15 minutes to get into this suit of armor and bring the droid systems online. It takes 3 full rounds to remove the armor.

The EVA pod has the following features.

**Strength Augmentation:** The powered servos give the operator a +4 equipment bonus to Strength.

**Life Support:** The suit provides full life support for 2 hours, with an internal air supply and protection against the most extreme environments, including vacuum.

**Comlink:** The armor's built-in comlink has a range of 100 kilometers and can send and receive encrypted messages.

**Powerlamp:** The armor includes a powerful lamp able to create a beam of light up to 100 meters long and 50 meters wide.

**Repair Kit:** The armor comes with sufficient tools to provide a +2 equipment bonus on all Repair checks.

## Other Protective Gear

Not all protective gear takes the form of physical armor, and not all types of protective gear are created with combat in mind. This category includes protective equipment that, while not armor in the traditional sense, does provide some protection or ability enhancement.

#### Ayelixe/Krongbing Textiles Camouflage Poncho

**Cost:** 250

**Damage Reduction:** -

**Maximum Dex Bonus:** -

**Armor Check Penalty:** -

**Speed:** 10 m/6 m

**Weight:** 1 kg

**Availability:** Prevalent

**Era:** ⚙️ ⚡️ ⚙️

The camouflage poncho is a simple piece of rugged cloth with a mottled pattern in colors appropriate to a particular type of terrain. Ponchos are typically available for arctic, desert, forest, mountain, plains, or swamp terrain. In addition to helping a figure to blend into the background, the poncho distorts the wearer's shape, making him more difficult to discern and identify. A camouflage poncho grants its wearer a +5 equipment bonus on Hide checks made in appropriate surroundings.

A camouflage poncho does not affect the damage reduction or other attributes of any worn armor beneath it.

#### Pacnorval Sonic Dampening Helmet

**Cost:** 600

**Damage Reduction:** -

**Maximum Dex Bonus:** -

**Armor Check Penalty:** -

**Speed:** 10 m/6 m

**Weight:** 1 kg

**Availability:** Common

**Era:** ⚡️ ⚙️

**Special:** This item grants the wearer sonic energy resistance 10 and provides a +2 equipment on Fortitude saves made against sonic attacks.

The Pacnorval sonic dampening helmet is designed to protect the wearer against the effects of sonic weapons. It is lightweight and comfortable and leaves the wearer with a full field of vision. Unfortunately, the distinctly characteristic design of the helmet reduces the wearer's ability to hear sounds (-10 penalty on Listen checks) and thus is rarely worn except by troops who themselves employ sonic weapons.

The helmet may be used in place of any other helmet designed for light armor. Sonic dampening helmets are not normally used with medium armor, and never with heavy or powered suits.

#### Rafkkind Industrials Dampener Aerosol

**Cost:** 600

**Damage Reduction:** -

**Maximum Dex Bonus:** -

**Armor Check Penalty:** -

**Speed:** 10 m/6 m

**Weight:** 0.5 kg

**Availability:** Common

**Era:** ⚙️ ⚡️ ⚙️

For those who want a little extra protection in a lightweight package, Rafkkind Industrial developed its unique Dampener Aerosol. Packaged in a can, this handy device creates a cloud of blaster-dispersing gas in a 2-meter-by-2-meter area when activated. The aerosol cloud may be placed in any space adjacent to the user. The cloud provides one-quarter concealment to anyone behind it (10% miss chance), and also counts as one-half cover for any energy attack made through it (giving targets a +4 cover bonus). The cloud lasts for 2d4 rounds before dispersing, though strong winds can reduce the dispersal time by half or more. Each can contains three charges.

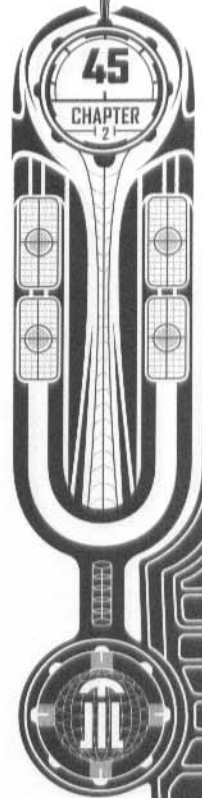

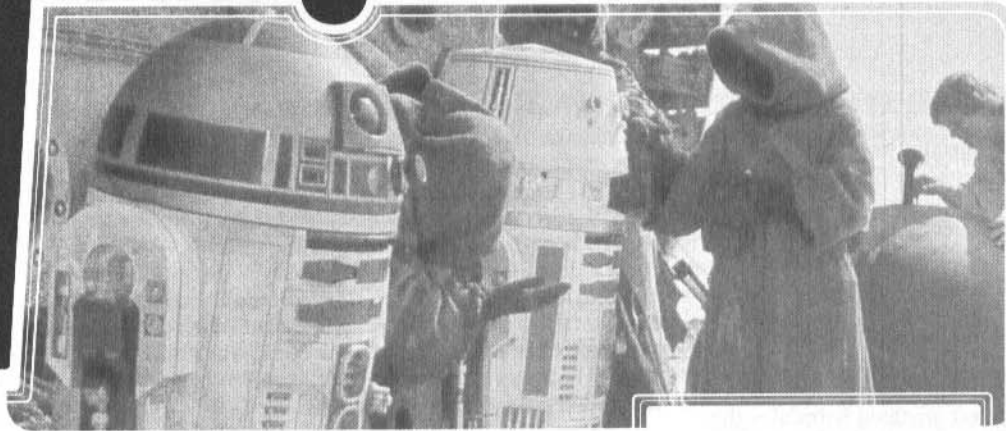

3

DROIDS

Droids range from simple automated cargo haulers to advanced self-aware, self-sufficient, and highly skilled individuals. Although a droid occasionally becomes its own master, most are owned by living creatures and are programmed to obey and assist them to the best of their abilities. They are in effect thinking tools, and are treated as such by the majority of the citizens of the galaxy.

The droids presented in this chapter are grouped by function and in some cases by size. The categories are astromech droids, repair droids, protocol and servant droids, medical droids, military droids, security and guard droids, surveillance droids, messenger droids, and labor droids. A final category covers a variety of unique droid types that don't fit into any other group.

These droids follow the rules given in Chapter Fifteen of the *Star Wars Roleplaying Game*. Because droids can be reprogrammed, their skill statistics include not just their total skill modifiers, but also the number of ranks they have in each skill (for easy recalculation). Droids receive one bonus language for each point of Intelligence bonus, just like other characters, so the number of unused bonus languages is given along with unspent skill points. Though most droids speak Basic, it is not unusual for a droid to be reprogrammed to speak a language appropriate to the market (for instance, almost all droids on Nar Shaddaa speak Huttese). Era information is included as well, though many droids may be encountered as prototypes before the era when they came into widespread use, and even the rarest types may be represented by one or two examples in an era later than the latest one indicated.

## Astromech Droids

Many technical droids are designed to help their owners live and fight in space, performing some duties as glorious as helping to fly a starfighter and some tasks so menial no crewmember wants to bother with them—or so dangerous none can risk them. In times of crisis, a droid can handle a minor task to free its owner to concentrate on bigger issues—such as an astromech droid taking the role of engineer or shield operator on a starfighter so the pilot is free to fly and shoot. A droid can also assist its owner in a cooperative task, making a skill check against DC 10 to give the owner a +2 bonus on the same skill (for more information on cooperation with skill checks, see Chapter Four of the *Star Wars Roleplaying Game*).

One company, Industrial Automaton, has defined the role of the modern astromech. Its collection of R series droids has proven to be superior to those of other producers, and even

its notable failures (such as the hapless R5 series) still find positions where their abilities can be used.

Astromechs are considered the epitome of second-degree droids, in that they are capable of handling both specific and variable tasks, and they show a strong sense of industry and dedication.

Most of the astromech droids are illustrated together on page xx. The R1 and P2 units are illustrated along with other large droids on the last page of this chapter.

### Industrial Automaton P2 Series Astromech Droid

**Classification:** Large second-degree astromech droid

**Cost:** 3,000

**Availability:** Common

**Era:**

The P2 was Industrial Automaton's first effort at an astromech droid for the commercial market. Initially sold only to the Old Republic's merchant fleet on a trial basis, the P2 was a modest success, but business setbacks prevented the model from being put into regular production. However, the P2 did allow Industrial Automaton to learn a great deal about astromech droid design, and eventually led to the successful R2 line.

In appearance, a P2 is essentially a 2.3-meter-tall R2 droid with a nonretractable claw attached to its dome. It serves much the same function as later R2 droids, but is not as skilled or as maneuverable. It lacks any audio communication capacity, and it can be controlled and understood only by a computer interface (either through its own comlink or by accessing a computer panel on the P2's body). Even so, P2s were popular with their owners, displaying much of the cheerful, positive attitude of their smaller cousins the R2s.

P2 series droids may be allowed as heroic characters.

**P2 Series:** Tracked astromech droid, Expert 1; Init +1 (Dex); Defense 10 (+1 Dex, -1 size); Spd 10 m; VP/WP 0/14; Atk +2 melee (1d4+3, claw) or +2 melee (1d2+3, saw) or +2 melee (2d6, arc welder) or +0 ranged; SV Fort +2, Ref +1, Will +1; SZ L; Face/Reach 4 m by 2 m/2 m; Rep +0; Str 16, Dex 12, Con 14, Int 14, Wis 8, Cha 10. Challenge Code A.

**Equipment:** Comlink, heuristic processor, sensors (infrared vision), diagnostics package, tool mounts (x8), magnetic feet, internal storage (10 kg), fire extinguisher.

**Skills:** Computer Use 4 ranks (+6), Disable Device 4 ranks (+6), Knowledge (astronomy) 4 ranks (+6), Pilot 4 ranks (+5), Read/Write Basic, Repair 4 ranks (+9), Spot 4 ranks (+3).

**Unspent Skill Points:** 8 (2 unused languages).

**Feats:** Ambidexterity, Skill Emphasis (Repair), Weapon Group Proficiencies (blaster pistols, simple weapons).

46

CHAPTER

3

### Industrial Automaton R1 Series Astromech Droid

**Classification:** Large second-degree astromech droid

**Cost:** 3,500

**Availability:** Common

**Era:** ☉

The R1 was an effort to improve upon the P2 and, at the same time, avoid further lawsuits. As a result, the droid was built in the frame of the existing Mark II Reactor Drone rather than the excellent P2 frame. The R1 is a 2.2-meter-tall droid with a black dome sitting atop a squat body, which itself sits atop a treaded unipod leg. The unipod turned out to be one of the R1's greatest weaknesses; not only is the droid slow, but it has a tendency to break down and get stuck.

Despite this flaw, and its bulky nature, the R1 is an excellent astromech, and is actually capable of plotting hyperspace jumps—a feat no droid its size had ever been able to accomplish before. R1s were mostly assigned to Old Republic capital ships, where they performed well. However, the droids have an unfortunate personality quirk that makes them surly at best and obstinate at worst. Regular memory wipes help somewhat with this problem, but as a result of these wipes, R1s are rarely very familiar with the ship they serve on. Still, they were popular enough during Old Republic days to be well maintained, and many continue to function well into The New Jedi Order era.

R1 series droids may be allowed as heroic characters.

**R1 Series:** Tracked astromech droid, Expert 3; Init +0; Defense 10 (+1 class, -1 size); Spd 6 m; VP/WP 0/16; Atk +5 melee (1d4+3, claw) or +5 melee (1d2+3, saw) or +5 melee (2d6, arc welder) or +2 ranged; SV Fort +4, Ref +1, Will +2;

SZ L; Face/Reach 4 m by 2 m/2 m; Rep +0; Str 16, Dex 10, Con 16, Int 14, Wis 8, Cha 6. Challenge Code A.

**Equipment:** Comlink, heuristic processor, sensors (improved sensors, infrared vision), diagnostics package, tool mounts (×6), magnetic feet, internal storage (10 kg), fire extinguisher.

**Skills:** Astrogate 6 ranks (+8), Computer Use 6 ranks (+8), Disable Device 6 ranks (+8), Knowledge (astronomy) 6 ranks (+8), Pilot 6 ranks (+6), Read/Write Basic, Speak Basic (understand only), Speak Binary, Repair 6 ranks (+11), Spot 6 ranks (+8).

**Unspent Skill Points:** 6 (2 unused languages).

**Feats:** Ambidexterity, Skill Emphasis (Repair), Skill Emphasis (Spot), Weapon Group Proficiencies (blaster pistols, simple weapons).

### Industrial Automaton R3 Series Astromech Droid

**Classification:** Small second-degree astromech droid

**Cost:** 10,000

**Availability:** Common, military

**Era:** ☉ ☽ ☿

The R3 series of droids resulted from an effort to take the success of the R2 and market it to the military. The R3 is similar in appearance to the R2, but features a transparent dome, which both increases the field of vision for its sensors and shows off the latest in computer processing technology. This impressive droid is able to maintain the specifications for thousands of starships in memory at once, and it can be programmed with even more data as needed for its duties. R3 droids have served successfully in the Old Republic, the Empire, and the New Republic, aiding gunners, astrogators,

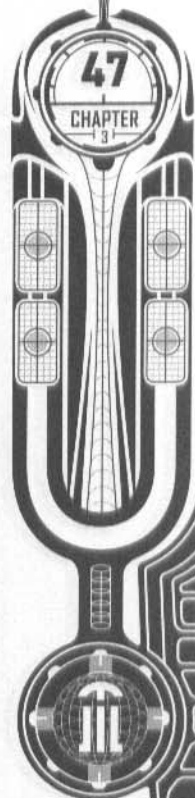
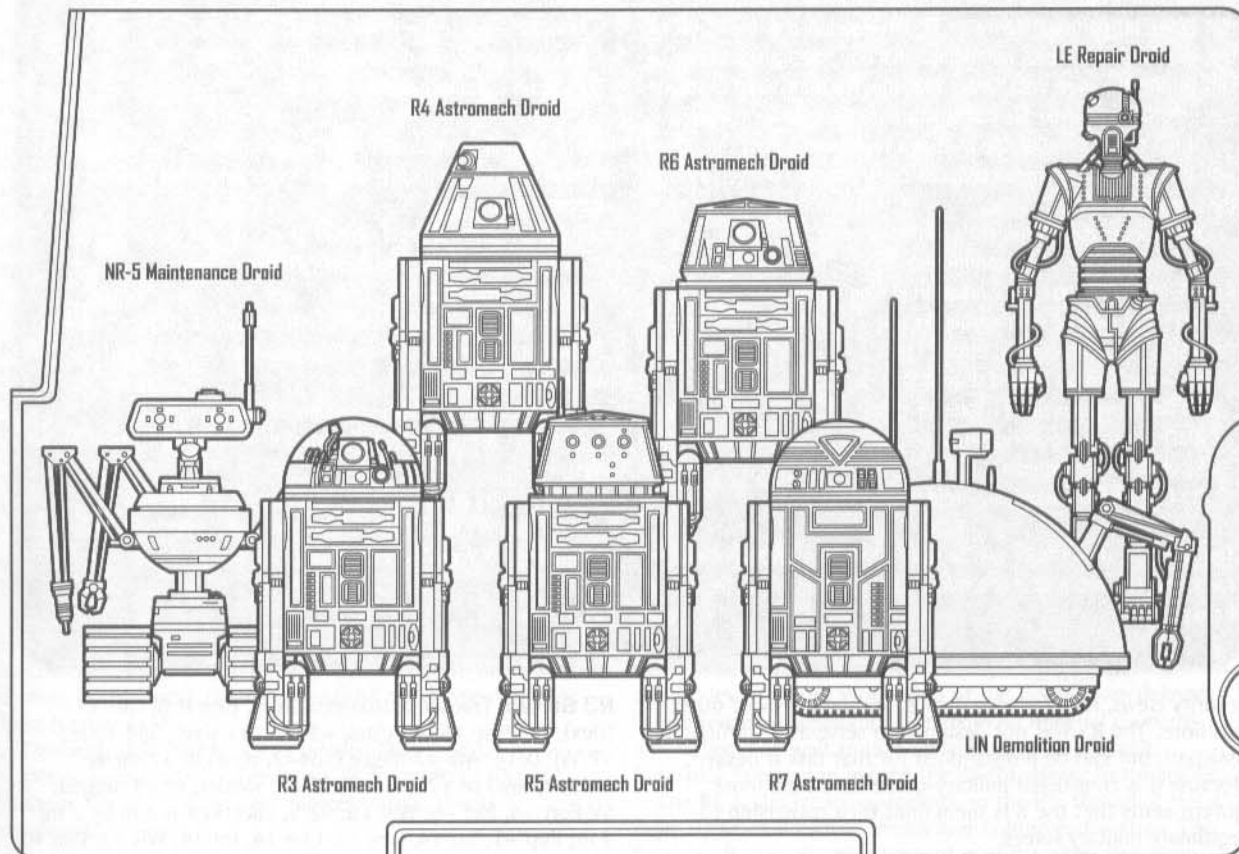

Many of the droids in this chapter are suitable for use as heroes—but the degree to which they'll make good player characters is entirely dependent on the style and level of game being played. To determine whether a droid would make a good hero in your game, look at the droid's class levels. You do not need to pick a degree, chassis, ability scores, or equipment—these are already spelled out in the droid descriptions here.

Many droids have only one level in a professional class. These droids can begin play as 1st-level characters without modification. Add one level in a heroic class of your choice, just as described in Chapter Fifteen of the *Star Wars Roleplaying Game*.

Other droids have multiple levels in professional classes. Any droid that has two or three professional class levels can be played as a 1st-level character—but you do not get to add a level in a heroic class. With its professional class levels, such a droid is already effectively a 1st-level character.

Droids of higher level cannot be played as 1st-level characters, but they can enter a game if all the heroes start above 1st level, or join a game in which the other heroes have already advanced somewhat. Any droid that has four or five professional class levels is effectively a 2nd-level hero; any droid with six or more professional levels is effectively a 3rd-level hero. Obviously, a droid with multiple levels in a heroic class is a hero of that level. (For example, the 501-Z has five levels of soldier, so it's already in effect a 5th-level character.)

Remember that playing a droid can have serious social implications. A Terminax TX droid is not a welcome sight among those familiar with it, because it's an assassin droid. Even if a player decides that TX-A1, his particular Terminax TX, has developed a respect for all life, most people it meets will assume that it is a tool programmed to kill. During the New Jedi Order era, the Yuuzhan Vong's attitude toward droids can make life particularly hazardous for them as well.

Droids that have only one level in a professional class (and thus, with the addition of a hero class, can begin play at 1st level) include the following.

- 3D-4X series administrative droid (diplomat 1)
- B1 series worker droid (commoner)
- CLL-8 Binary Load Lifter worker droid (commoner)
- MD series medical droid (expert 1)
- MSE-6 series repair droid (expert 1)
- P2 series astromech droid (expert 1)
- PD series protocol droid (diplomat 1)
- RMD-20 series monitoring droid (expert 1)
- Scrubber droid (expert 1)
- U2-C1 series housekeeping droid (expert 1)

The following droids have two or three levels in a professional class (and thus can begin play at 1st level, but without the addition of a hero class).

- 11-17 series mining droid (expert 3)
- EV series supervisor/interrogator droid (expert 1/thug 1)
- G-2RD series guard droid (thug 3)
- LOM series protocol droid (diplomat 2)
- M38 series explorer droid (expert 3)
- M-3PO series protocol droid (diplomat 1/thug 1)
- R1 series astromech droid (expert 3)
- R4 series astromech droid (expert 3)
- R5 series astromech droid (expert 3)
- SE4 series protocol droid (diplomat 2)
- TTS-15 series tutorial droid (expert 3)

Droids with four or five levels in a professional class (and that are effectively 2nd-level characters before the addition of any hero levels) include the following.

- CZ series communications droid (diplomat 4)
- DRK-1 series probe droid (thug 4)
- GV series guardian droid (thug 4)
- M4 series messenger droid (thug 4)
- NR-5 series repair droid (expert 4)
- RA-7 series protocol droid (diplomat 4)

The following droids have six or more levels in a professional class, making them effectively 3rd-level characters before the addition of any hero levels.

- Eradicator series battle droid (thug 8)
- Mark VII series seeker droid (thug 8)
- R3 series astromech droid (expert 6)
- R6 series astromech droid (expert 6)

Finally, the following droids have levels in heroic classes. They are already characters of their respective levels before the addition of any additional hero levels.

- 501-Z series police droid (soldier 5)
- AS-M12 series messenger droid (scout 5)
- DZ series tracker droid (scout 5)
- LE series repair droid (expert 1/tech specialist 2; treat as 2nd level)
- LIN Demolitionmech Series industrial droid (expert 1/tech specialist 2; treat as 2nd level)
- Mark X Executioner Series gladiatorial droid (soldier 5)
- R7 Series astromech droid (expert 8/starship ace 1; treat as 5th level)
- SD-9 infantry droid (thug 3/soldier 3; treat as 4th level)
- SD-10 infantry droid (thug 3/soldier 6; treat as 7th level)
- Terminax TX Series assassin droid (soldier 7)

security crews, maintenance details, and hundreds of other positions. The R3 was not designed to serve as a starfighter assistant, but can be programmed for that task if desired. Because it is considered military-grade hardware, most governments that use R3s them limit their ownership to legitimate military forces.

R3 series droids may be allowed as heroic characters.

**R3 Series:** Tracked astromech droid, Expert 6; Init +3 (Dex); Defense 16 (+2 class, +3 Dex, +1 size); Spd 10 m; VP/WP 0/14; Atk +7 melee (1d4+2, claw) or +7 melee (1d2+2, saw) or +7 melee (2d6, arc welder) or +8 ranged; SV Fort +4, Ref +5, Will +6; SZ S; Face/Reach 2 m by 2 m/2 m; Rep +1; Str 14, Dex 16, Con 14, Int 18, Wis 12, Cha 10. Challenge Code B.

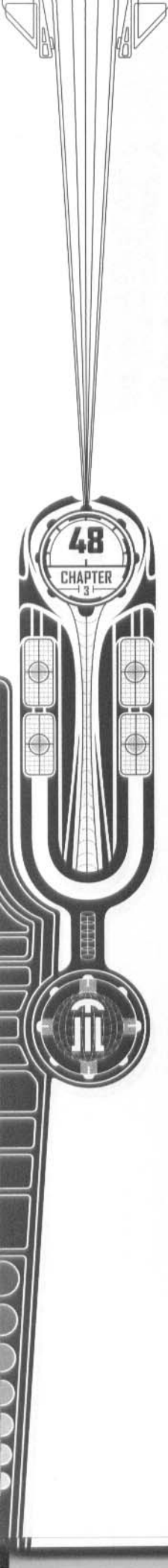



**Equipment:** Comlink, heuristic processor, sensors (improved sensors, infrared vision, 360-degree vision), diagnostics package, recording unit (holo), tool mounts (x4), telescopic appendage, magnetic feet, internal storage (2 kg), fire extinguisher.

**Skills:** Astrogate 9 ranks (+13), Computer Use 9 ranks (+13), Disable Device 9 ranks (+13), Knowledge (astronomy) 9 ranks (+13), Pilot 9 ranks (+12), Read/Write Basic, Repair 9 ranks (+13), Speak Basic (understand only), Speak Binary, Spot 9 ranks (+12).

**Unspent Skill Points:** 27 (4 unused languages).

**Feats:** Ambidexterity, Starship Operation (capital ships, space transports), Weapon Group Proficiencies (blaster pistols, simple weapons).

**Unassigned Feats:** 1.

#### **Industrial Automaton R4 Series Astromech Droid**

**Classification:** Small second-degree astromech droid

**Cost:** 2,500

**Availability:** Prevalent

**Era:**   

Like the R3, the R4 was designed to duplicate the success of the R2 in a new market. In the case of the R4, the idea was to make a droid useful for citizens who don't own starfighters but might have speeders or holorecorders that break down regularly. The hope was that a cheaper droid able to keep equipment up and running would be a good investment for groups in the Outer Rim or off the normal hyperspace routes. This droid is made to be inexpensive and sturdy, and is hugely popular. Many continue to function hundreds of years after their construction.

In appearance R4s are similar to R2 and R3 droids, but the dome has been replaced with a truncated cone. Internally the R4 has more storage, but lacks such fine details as video displays or fire extinguishers (though that could always be changed if an owner desires). The attitude of the R4 is also a success; if anything, it is even more helpful and loyal than the typical R2 droid, though it is less apt to attempt to fix things without being told to do so. Most R4s become thought of as friends or pets and are never memory wiped unless they change owners—and not always even then.

R4 series droids may be allowed as heroic characters.

**R4 Series:** Tracked astromech droid, Expert 3; Init +2 (Dex); Defense 14 (+1 class, +2 Dex, +1 size); Spd 8 m; VP/WP 0/16; Atk +4 melee (1d4+2, claw) or +4 melee (1d2+2, saw) or +4 melee (2d6, arc welder) or +4 ranged; SV Fort +4, Ref +3, Will +3; SZ S; Face/Reach 2 m by 2 m/2 m; Rep +0; Str 14, Dex 14, Con 16, Int 16, Wis 10, Cha 11. Challenge Code B.

**Equipment:** Comlink, heuristic processor, sensors (infrared vision), diagnostics package, tool kit, tool mounts (x4), internal storage (8 kg).

**Skills:** Computer Use 6 ranks (+11), Craft (mechanics) 6 ranks (+11), Disable Device 6 ranks (+9), Knowledge (world lore) 6 ranks (+9), Pilot 6 ranks (+8), Read/Write Basic, Repair 6 ranks (+16), Speak Basic (understand only), Speak Binary, Spot 6 ranks (+6).

**Unspent Skill Points:** 12 (3 unused languages).

**Feats:** Ambidexterity, Gearhead, Skill Emphasis (Repair), Weapon Group Proficiencies (blaster pistols, simple weapons).

#### **Industrial Automaton R5 Series Astromech Droid**

**Classification:** Small second-degree astromech droid

**Cost:** 1,500

**Availability:** Prevalent

**Era:** 

The R5 series of droids suffers from one huge design flaw—it was created without any specific market in mind. Though cheaper than even the R4 series, the R5 is not tough enough to survive long in the harsh environments of the Outer Rim worlds. Though equipped to plug into a starfighter, the R5 isn't of much use once installed. Even worse, the droid picks up personality quirks at an amazing rate. (New R5s already have one quirk, and used ones have at least two.) Industrial Automaton built the R5 droid for no other reason than to come out with a new model, and the lack of vision shows. Initial sales were abysmal, and the line was discontinued within a few years.

But in that time, hundreds of thousands of R5s were built and sold. The droid is similar in appearance to an R2, but the dome is less graceful—it's often described as an inverted flowerpot. Because any R-series droid is sometimes better than none, many R5s are modified to become more useful. With extensive reprogramming, R5s are generally serviceable, but they don't compare to most other droids in the R series.

R5 series droids may be allowed as heroic characters.

**R5 Series:** Tracked astromech droid, Expert 3; Init +0; Defense 12 (+1 class, +1 size); Spd 8 m; VP/WP 0/12; Atk +4 melee (1d4+2, claw) or +4 melee (1d2+2, saw) or +4 melee (2d6, arc welder) or +2 ranged; SV Fort +2, Ref +1, Will +3; SZ S; Face/Reach 2 m by 2 m/2 m; Rep +0; Str 14, Dex 10, Con 12, Int 12, Wis 10, Cha 8. Challenge Code B.

**Equipment:** Comlink, heuristic processor, sensors (improved sensors, infrared vision, 360-degree vision), diagnostics package, recording unit (holo), tool mounts (x4), telescopic appendage, magnetic feet, internal storage (2 kg), fire extinguisher.

**Skills:** Astrogate 1 rank (+2), Computer Use 6 ranks (+7), Disable Device 1 rank (+4), Knowledge (astronomy) 6 ranks (+7), Pilot 3 ranks (+3), Read/Write Basic, Speak Basic (understand only), Speak Binary, Repair 6 ranks (+7), Spot 0 ranks (+2).

**Unspent Skill Points:** 19 (1 unused language).

**Feats:** Ambidexterity, Cautious, Run, Weapon Group Proficiencies (blaster pistols, simple weapons).

#### **Industrial Automaton R6 Series Astromech Droid**

**Classification:** Small second-degree astromech droid

**Cost:** 6,000

**Availability:** Prevalent

**Era:** 

After the great victory of the Rebel Alliance at the Battle of Endor, Industrial Automaton saw an opportunity to erase the memory of the R5 fiasco from the galactic public. The company sought and achieved a military contract with the New Republic, focusing on creating an astromech droid to assist pilots in operating the complex E-wing fighter that was also in development. Production of the E-wing was delayed by the tenacious resistance of remaining Imperial elements, and rather than wait to take advantage of its research, Industrial Automaton revised the R6 for release to the public.

The R6 is similar in appearance to the R5, though it has a more traditional central sensor and holoprojector array. The R6 is in all ways an improvement over the older and more

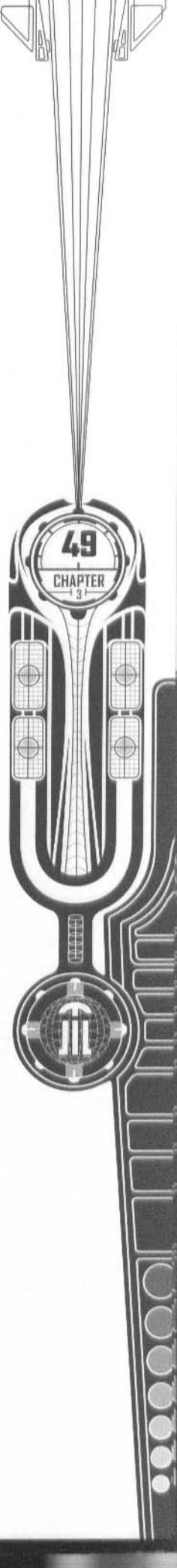

successful R-series droids, suffering none of the R5's weaknesses. R6 droids are bright, cheerful, helpful and loyal, as well as highly skilled and well equipped for a wide variety of tasks. R6 droids have been in high demand since their release, and in many cases are sold out long before all orders are fulfilled.

R6 series droids may be allowed as heroic characters.

**R6 Series:** Tracked astromech droid, Expert 6; Init +3 (Dex); Defense 16 (+2 class, +3 Dex, +1 size); Spd 10 m; VP/WP 0/14; Atk +7 melee (1d4+2, claw) or +7 melee (1d2+2, saw) or +7 melee (2d6, arc welder) or +8 ranged; SV Fort +4, Ref +5, Will +6; SZ S; Face/Reach 2 m by 2 m/2 m; Rep +1; Str 14, Dex 16, Con 14, Int 20, Wis 12, Cha 12. Challenge Code B.

**Equipment:** Comlink, heuristic processor, sensors (improved sensors, infrared vision, 360-degree vision), diagnostics package, recording unit (holo), tool mounts (x4), telescopic appendage, magnetic feet, internal storage (2 kg), fire extinguisher.

**Skills:** Astrogate 9 ranks (+14), Computer Use 9 ranks (+16), Disable Device 9 ranks (+14), Knowledge (astronomy) 9 ranks (+14), Pilot 9 ranks (+12), Read/Write Basic, Repair 9 ranks (+16), Search 9 ranks (+16), Speak Basic (understand only), Speak Binary, Spot 9 ranks (+12).

**Unspent Skill Points:** 27 (5 unused languages).

**Feats:** Ambidexterity, Gearhead, Starship Operation (space transports, starfighters), Weapon Group Proficiencies (blaster pistols, simple weapons).

#### Industrial Automaton R7 Series Astromech Droid

**Classification:** Small second-degree astromech droid

**Cost:** 8,000

**Availability:** Specialized

**Era:** Ⓞ

The R7 is the most advanced astromech droid ever created. However, it was designed to operate exclusively in an E-wing fighter and does not do well in any other model of starfighter. It is also extremely expensive, making it too costly for the New Republic to use for anything but those E-wings that see regular duty. Though not technically a military droid, the R7 is of very little interest to anyone who doesn't have access to an E-wing, and is not generally sold to the public. In appearance the R7 is close to the R2 series, though R7s have a triangular main sensor.

The benefits of operating an E-wing with an R7 droid are fairly obvious. If the pilot is not himself a starfighter ace, the R7's starfighter evasion ability grants the E-wing a +1 defense bonus. The R7 can also fly the ship, freeing the pilot to act as a gunner rather than divide his concentration. However, the R7 is only able to operate in this way with an E-wing fighter; it isn't even proficient when installed in other starfighters (resulting in a -4 penalty on any Pilot checks it makes, and preventing it from using its starfighter evasion ability). In theory it might be possible to reprogram an R7 to operate in other fighters (Computer Use check DC 30; a reprogrammed R7 would no longer be restricted to any particular model of starfighter), but no one has ever reported doing so.

R7 series droids should only be allowed as heroic characters in high-level campaigns.

**R7 Series:** Tracked astromech droid, Expert 8/Starship Ace (E-wing) 1; Init +7 (+3 Dex, +4 Improved Initiative); Defense

17 (+3 class, +3 Dex, +1 size); Spd 10 m; VP/WP 6/14; Atk +9/+4 melee (1d4+2, claw) or +9/+4 melee (2d6, arc welder) or +10/+5 ranged; SQ Starfighter defense +1; SV Fort +5, Ref +7, Will +8; SZ S; Face/Reach 2 m by 2 m/2 m; Rep +2; Str 14, Dex 16, Con 14, Int 20, Wis 12, Cha 12. Challenge Code C.

**Equipment:** Comlink, heuristic processor, sensors (improved sensors, infrared vision, 360-degree vision), diagnostics package, recording unit (holo), tool mounts (x2), telescopic appendage, environmental compensator (vacuum), magnetic feet, internal storage (1 kg), fire extinguisher.

**Skills:** Astrogate 12 ranks (+19), Computer Use 12 ranks (+17), Disable Device 9 ranks (+14), Knowledge (astronomy) 12 ranks (+17), Pilot 12 ranks (+19), Read/Write Basic, Repair 9 ranks (+14), Search 9 ranks (+16), Speak Basic (understand only), Speak Binary, Spot 9 ranks (+12).

**Unspent Skill Points:** 46 (5 unused languages).

**Feats:** Ambidexterity, Improved Initiative, Spacer, Starship Dodge, Starship Operation (E-wing starfighter), Weapon Group Proficiencies (blaster pistols, simple weapons).

## Repair Droids

While astromechs are foremost among interstellar repair droids, they are not by any means the only type. Various other repair and maintenance droids have been developed over the years to meet specific needs of consumers. While these may not be as common as the ubiquitous astromechs, they find their place in both groundside settings and on large stations.

Most of the repair droids are illustrated together on page xx. The MSE-6 unit is illustrated along with other small droids on the last page of this chapter.

#### Cybot Galactica LE Series Repair Droid

**Classification:** Medium-size second-degree repair droid

**Cost:** 12,000

**Availability:** Common

**Era:** Ⓞ Ⓜ Ⓝ

The idea behind the LE series of droids was to combine the repair function of an astromech droid with the administrative uses of a protocol droid. Cybot Galactica believed that such a droid would appeal to independent space transport captains and hoped such consumers would be willing to pay the premium that came from concentrating so much functionality into one unit. The LE was designed in a bipedal, humanoid form to allow it to more easily deal with spaceport officials and loading dock crews. This form reduced its effectiveness as a repair droid slightly, but Cybot assumed the LE could carry and use the same tools its owners did. Rather than concentrating on etiquette and protocol, which are often irrelevant in the rough-and-tumble universe of the independent transport captain, LEs are programmed with administration skills, common spacer information, and extensive files on all varieties of space transports.

Though the model was a modest success, it was not the huge seller Cybot Galactica had hoped for. The LE has been in production for several generations and is now appearing more often on capital ships (after extensive experience or reprogramming) and in port offices, which use LEs to handle the red tape that ship captains employ them to avoid. This droid's tech specialist expert emphasis is usually (though not always) in space transports; some LEs specialize in speeders, vehicles, capital ships, starfighters, and even other droids.

LE series droids may be allowed as heroic characters.

**LE Series:** Walking repair droid, Expert 1/Tech Specialist 2; Init -1 (Dex); Defense 12 (+3 class, -1 Dex); DR 3; Spd 10 m; VP/WP 9/12; Atk +2 melee (1d3+1, hand) or +0 ranged; SQ Research; SV Fort +1, Ref +0, Will +4; SZ M; Face/Reach 2 m by 2 m/2 m; Rep +0; Str 12, Dex 8, Con 12, Int 18, Wis 13, Cha 14. Challenge Code A.

**Equipment:** Light armor, comlink, heuristic processor, sensors (telescopic vision), recording unit (holo), translator unit (DC 15).

**Skills:** Astrogate 6 ranks (+10), Computer Use 4 ranks (+8), Diplomacy 4 ranks (+6), Disable Device 6 ranks (+10), Knowledge (engineering) 6 ranks (+10), Knowledge (technology) 6 ranks (+10), Profession (administrator) 6 ranks (+7), Read/Write Basic, Repair 6 ranks (+13), Search 4 ranks (+8), Speak Basic, Speak Binary.

**Unspent Skill Points:** 8 (4 unused languages).

**Feats:** Ambidexterity, Skill Emphasis (Repair), Starship Operations (space transports), Weapon Group Proficiencies (blaster pistols, simple weapons).

#### **Cybot Galactica LIN Demolitionmech Series Industrial Droid**

**Classification:** Medium-size second-degree industrial droid

**Cost:** 7,000

**Availability:** Common

**Era:** 

The LIN Demolitionmech is a specialty droid designed to place and remove explosives in commercial work, such as mining and industrial wrecking. It is a tracked droid approximately 0.7 meters tall, covered in a dome of reinforced industrial durasteel blast armor. The weight of the dome reduces the droid's movement greatly, but this is considered an acceptable trade-off in the design. The droid has a single claw that extends from the dome, as well as several retractable comlink antennae and sensors. The droid's internal storage bay can be geared to carry a variety of explosives, with a typical load being 16 kilograms of explosives or 20 grenades.

Of course, it didn't take long for military groups to see the advantage of using LIN Demolitionmechs for planting explosives and delivering grenades. Since its arm can rotate around its body, it is capable of placing explosives in its own tracks, and its comlink allows it to receive orders over great distances. The droid is vulnerable to moisture, but usually operates excellently if well maintained. The droid went out of production after being blamed for an accident on the world of Gosfambing that killed six hundred miners. Many remain in operating condition, however, and are much beloved by their owners.

This droid's tech specialist expert emphasis is usually (though not always) in simple weapons, to reflect its ability to handle explosive devices such as grenades.

LIN Demolitionmech droids may be allowed as heroic characters.

**LIN Demolitionmech Series:** Tracked demolitions droid, Expert 1/Tech Specialist 2; Init +0; Defense 13 (+3 class); DR 7; Spd 4 m; VP/WP 17/20; Atk +4 melee (1d4+3, claw) or +1 ranged; SQ Research; SV Fort +5, Ref +1, Will +6; SZ M; Face/Reach 2 m by 2 m/2 m; Rep +0; Str 16, Dex 10, Con 20, Int 18, Wis 16, Cha 10. Challenge Code A.

**Equipment:** Heavy armor, comlink, heuristic processor, sensors (infrared vision, 360-degree vision), environmental compensator (dust, heat), internal storage (20 kg), telescopic appendage.

**Skills:** Computer Use 6 ranks (+10), Demolitions 6 ranks (+15), Disable Device 6 ranks (+12), Knowledge (chemistry) 4 ranks (+8), Repair 4 ranks (+8), Search 4 ranks (+8). Speak Basic (understand only), Speak Binary.

**Unspent Skill Points:** 26 (4 unused languages).

**Feats:** Cautious, Skill Emphasis (Demolitions), Weapon Group Proficiencies (blaster pistols, simple weapons).

#### **Kalibac Industries NR-5 Series Repair Droid**

**Classification:** Small fifth-degree repair droid

**Cost:** 2,200

**Availability:** Prevalent

**Era:**   

When first introduced, the awkward NR-5 was considered the perfect maintenance droid. Intelligent and skilled enough to carry out a wide variety of tasks, but not so curious as to get itself into trouble, the NR-5 was hugely popular with individuals who needed additional technical help they could count on. At only 0.7 meters tall, the droid fits into most repair bays without modifications. Its two heavy tracks keep it remarkably stable, its three limbs make it handy, and its square head and round body are often seen as cute. NR-5s are famous for their determination, which can be both a boon and a liability. Some NR-5s refuse to leave their jobs until they have been completed.

The only problem with the NR-5 series is that the droid isn't particularly sturdy. Though it works fine in the clean environment of a starship, it often doesn't do well in the harsh conditions of Outer Rim worlds. When the R4 droid was introduced by Industrial Automaton, sales of the NR-5 dropped considerably. Still, in gentle conditions the NR-5 generally does a better job than the R4, and many remain in use well into The New Jedi Order era.

NR-5 series droids may be allowed as heroic characters.

**NR-5 Series:** Tracked repair droid, Expert 4; Init +0; Defense 12 (+1 class, +1 size); Spd 4 m; VP/WP 0/10; Atk +4 melee (1d4+1, claw) or +3 ranged; SV Fort +1, Ref +1, Will +6; SZ S; Face/Reach 2 m by 2 m/2 m; Rep +1; Str 12, Dex 10, Con 10, Int 18, Wis 14, Cha 6. Challenge Code A.

**Equipment:** Comlink, sensors (infrared vision, low-light vision), diagnostics package, secondary battery, telescopic appendage, tool kit, tool mounts (x3), vocabulator.

**Skills:** Computer Use 7 ranks (+11), Craft (droids) 7 ranks (+11), Craft (tools) 7 ranks (+11), Craft (any one class of starship) 7 ranks (+11), Disable Device 7 ranks (+13), Knowledge (engineering) 7 ranks (+11), Read/Write Basic, Repair 7 ranks (+14), Search 7 ranks (+11), Speak Basic, Speak Binary, Spot 7 ranks (+9).

**Unspent Skill Points:** 7 (4 unused languages).

**Feats:** Ambidexterity, Cautious, Skill Emphasis (Repair), Weapon Group Proficiencies (blaster pistols, simple weapons).

#### **Rebaxan Columi MSE-6 Series Repair Droid ("Mouse Droid")**

**Classification:** Diminutive fifth-degree repair droid

**Cost:** 2,000

**Availability:** Prevalent

**Era:**   

The MSE-6 may be the most common droid to have been a financial disaster for its manufacturer. Produced in huge numbers at the end of the Old Republic, the small, squeaky, timid droid had dismal sales and actually led to the bank-

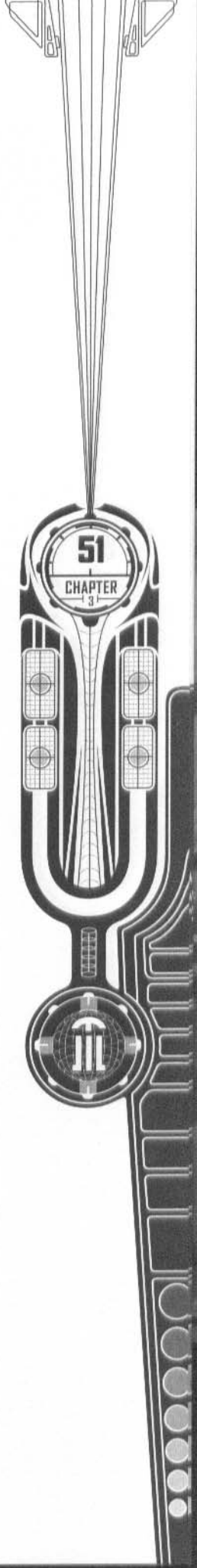

ruptcy of Rebaxan Columni. The droid is best described as a small black box on wheels, and it communicates in a very high-pitched version of the binary language. It was specifically designed to resemble a small rodentlike creature, which turns out to annoy almost everyone who interacts with one.

However, the MSE-6 is cheap and not totally useless, and it found a home in the Imperial military forces. Each droid is generally programmed to perform a single task (basic maintenance, messenger duty, or computer upgrades, for example) that it carries out with single-minded zeal. The droid has two small manipulators concealed within its frame, as well as a locked compartment that can be used to carry messages (or, in at least one recorded case, explosives). The droid isn't really suited for military duty, however, since it constantly beeps and chirps, and it flees from the slightest threat or loud noise. Ubiquitous and cowardly, "mouse droids" have nevertheless survived into The New Jedi Order era.

MSE-6 droids may be allowed as heroic characters.

**MSE-6 Series:** Wheeled general purpose droid, Expert 1; Init +3 (Dex); Defense 17 (+3 Dex, +4 size); Spd 6 m; VP/WP 0/10; Atk +1 melee (0, claw) or +7 ranged; SV Fort +0, Ref +3, Will +2; SZ D; Face/Reach 0.5 m by 0.5 m/0 m; Rep +0; Str 4, Dex 16, Con 10, Int 10, Wis 10, Cha 6. Challenge Code A.

**Equipment:** Internal storage (1 kg), locked access, recording unit (holo).

**Skills:** Computer Use 4 ranks (+4), Listen 4 ranks (+4), Repair 4 ranks (+7), Search 4 ranks (+4), Speak Basic (understand only), Speak Binary, Spot 4 ranks (+4).

**Unspent Skill Points:** 4.

**Feats:** Ambidexterity, Skill Emphasis (Repair), Weapon Group Proficiencies (blaster pistols, simple weapons).

## Protocol and Commercial Droids

Much as astromech droids help with life in space, many series of droids are designed to help with life in more everyday settings. Some are specialists, such as protocol droids, that assist their owners with complex or scholarly information. Others are simply menial servants, working to free up their owners' time. Because a droid can be a major investment for a common citizen, there are some very generic designs in this category, intended to assist at the widest possible range of tasks—but lacking the skills to excel at any of them.

Protocol droids generally employ third-degree droid brains, and often pick up nervous Human mannerisms in the dispensing of their tasks. Because many of their duties involve dealing with Humans and humanoids, sometimes these very quirks are endearing to their masters and prevent them from having their memories wiped.

Protocol droids tend to be humanoid in form. They are illustrated together on page xx.

### Arakyd Industries RA-7 Series Protocol Droid ("Death Star Droid")

**Classification:** Medium-size third-degree protocol droid

**Cost:** 3,000

**Availability:** Prevalent

**Era:**  

The RA-7 is Arakyd Industries' only personal assistant droid model, and most believe this is because the droid is a failure. It is true that RA-7s are bland, uninteresting, unhelpful and not very bright, but they are actually a very profitable line

for Arakyd. The droid was bought in huge numbers by the Empire, which distributed them to thousands of mid-level officers, governors and functionaries as gifts. Since no one was willing to offend the Empire by getting rid of the droids, they became a common sight in many Imperial installations, especially the on Death Star (hence the additional sobriquet).

At first glance there is no obvious reason why the Empire loved these droids so much. The flat black droid looks much like any typical protocol model, except for its larger-than-usual head equipped with buglike, compound eyes. Many Imperial citizens assumed the proliferation of RA-7s was just budgetary excess. In truth, the RA-7 is equipped with hidden cameras and comlinks, and it is programmed to gather information for the Imperial Security Bureau.

The concealed hardware and programming is well hidden and cannot be uncovered during a routine checkup. Finding the hidden programming requires a Computer Use check (DC 30), and finding the comlink and holorecorder takes a Search check (DC 25).

RA-7 droids may be allowed as heroic characters.

**RA-7 Series:** Walking protocol droid, Diplomat 4; Init +0; Defense 11 (+1 class); Spd 8 m; VP/WP 0/10; Atk +2 melee (1d3, hand) or +2 ranged; SV Fort +1, Ref +1, Will +4; SZ M; Face/Reach 2 m by 2 m/2 m; Rep +1; Str 10, Dex 10, Con 10, Int 10, Wis 10, Cha 10. Challenge Code A.

**Equipment:** Concealed comlink, concealed recording unit (holo), sensors (improved sensor package, low-light vision), translator unit (DC 10), vocabulator.

**Skills:** Computer Use 4 ranks (+4), Diplomacy 1 rank (+1), Gather information 7 ranks (+10), Knowledge (bureaucracy) 1 rank (+1), Listen 3 ranks (+7), Profession (administrator) 1 rank (+1), Read/Write Basic, Speak Basic, Spot 3 ranks (+7).

**Unspent Skill Points:** 4.

**Feats:** Alertness, Ambidexterity, Skill Emphasis (Gather Information), Weapon Group Proficiencies (blaster pistols, simple weapons).

### Cybot Galactica PD Series "Lurrian" Protocol Droid

**Classification:** Medium-size third-degree protocol droid

**Cost:** 4,000

**Availability:** Prevalent

**Era:**  

The PD series of protocol droids is a perfect example of how a business plan can be ruined by external forces. Cybot Galactica, looking for a way to expand its protocol droid market, decided to build a revised version of the 3PO for sale to the Lurrians, a species of humanoids who are geniuses in the field of genetics, but who live on a harsh, icy world that destroys most droids in short order. Even worse, Lurrians live in cliff cities and mountains, where winds are too high for repulsorlift droids to maneuver.

The redesign was well planned and well executed. The typical bipedal droid frame was replaced with a more sturdy design sealed against the harsh climate. The head was recast in a shape closer to a Lurrian's, increasing the droid's visual appeal. The hands were strengthened, and a grapplelike feature added: The hand can be launched up to 20 meters as a grappling hook; a cable keeps it connected to the body of the droid. Much of the translator unit was replaced with information on Lurrian culture and genetics. The Lurrians were thrilled with the design and ordered thousands of the droids. Then the Empire placed Lur under quarantine, and no deliveries could be made.

To recoup its losses, Cybot Galactica sells the droid at below cost, but it is still more expensive than a typical 3PO unit. PD droids, also called Lurrian Protocol droids, are not common, but those in service perform adequately in most circumstances, and they are sought after by biologists and geneticists as prized assistants. Due to their hardy construction they rarely break down, and most of the initial production run remains in service long after its manufacture.

PD series droids may be allowed as heroic characters.

**PD Series:** Walking Lurrian protocol droid, Diplomat 1; Init +1 (Dex); Defense 11 (+1 Dex); Spd 10 m; VP/WP 0/12; Atk +1 melee (1d3+1, hand) or +1 ranged; SV Fort +3, Ref +1, Will +2; SZ M; Face/Reach 2 m by 2 m/20 m; Rep +0; Str 12, Dex 12, Con 12, Int 16, Wis 10, Cha 10. Challenge Code A.

**Equipment:** Climbing cable hands (function as reusable grappling spike launchers), environmental compensator (cold, dust, water), recording unit (audio), translator unit (DC 10), vocabulator.

**Skills:** Climb 2 ranks (+3), Computer Use 4 ranks (+7), Diplomacy 4 ranks (+4), Knowledge (genetics) 4 ranks (+7), Knowledge (biology) 4 ranks (+7), Read/Write Basic, Speak Basic.

**Unspent Skill Points:** 8 (3 unused languages).

**Feats:** Ambidexterity, Great Fortitude, Weapon Group Proficiencies (blaster pistols, simple weapons).

#### Genetech 3D-4X Series Administrative Droid

**Classification:** Medium-size third-degree administrative droid

**Cost:** 5,500

**Availability:** Prevalent

**Era:**    

When trying to break into the personal assistant and protocol droid market, Genetech realized that competing directly with the 3PO line of droids was not a strong marketing choice.

Instead, they designed the 3D-4X series as a specialized assistant droid intended to focus on systems administration, business matters, and formal etiquette. The 3D-4X's appearance is roughly humanoid, with an outer frame of highly polished silver chromite. Its head, shaped like an inverted test tube, sports a single off-center photoreceptor.

The 3D-4X performs the same basic function as any protocol droid—it translates and advises on proper behavior—but its different emphasis makes the 3D-4X more popular with major executives. To further set it apart from typical protocol droids, the 3D-4X is equipped with several concealed storage compartments and a heuristic processor.

Unlike most protocol droids, the 3D-4X series' personality could not be described as prissy or jumpy. Although the droid is supposed to seem aloof and deferential, it occasionally slips toward sardonic. This tendency can be cured with a memory wipe, but owners are often loath to lose the years of experience a 3D-4X can accumulate.

3D-4X droids may be allowed as heroic characters.

**3D-4X Series:** Walking administrative droid, Diplomat 1; Init +0; Defense 10; Spd 10 m; VP/WP 0/13; Atk -1 melee (1d3-1, hand) or +0 ranged; SV Fort +1, Ref +0, Will +3; SZ M; Face/Reach 2 m by 2 m/2 m; Rep +0; Str 8, Dex 10, Con 13, Int 16, Wis 13, Cha 16. Challenge Code; A

**Equipment:** Heuristic processor, comlink, translator unit (DC 10), recording unit (audio), internal storage (2 kg), vocabulator.

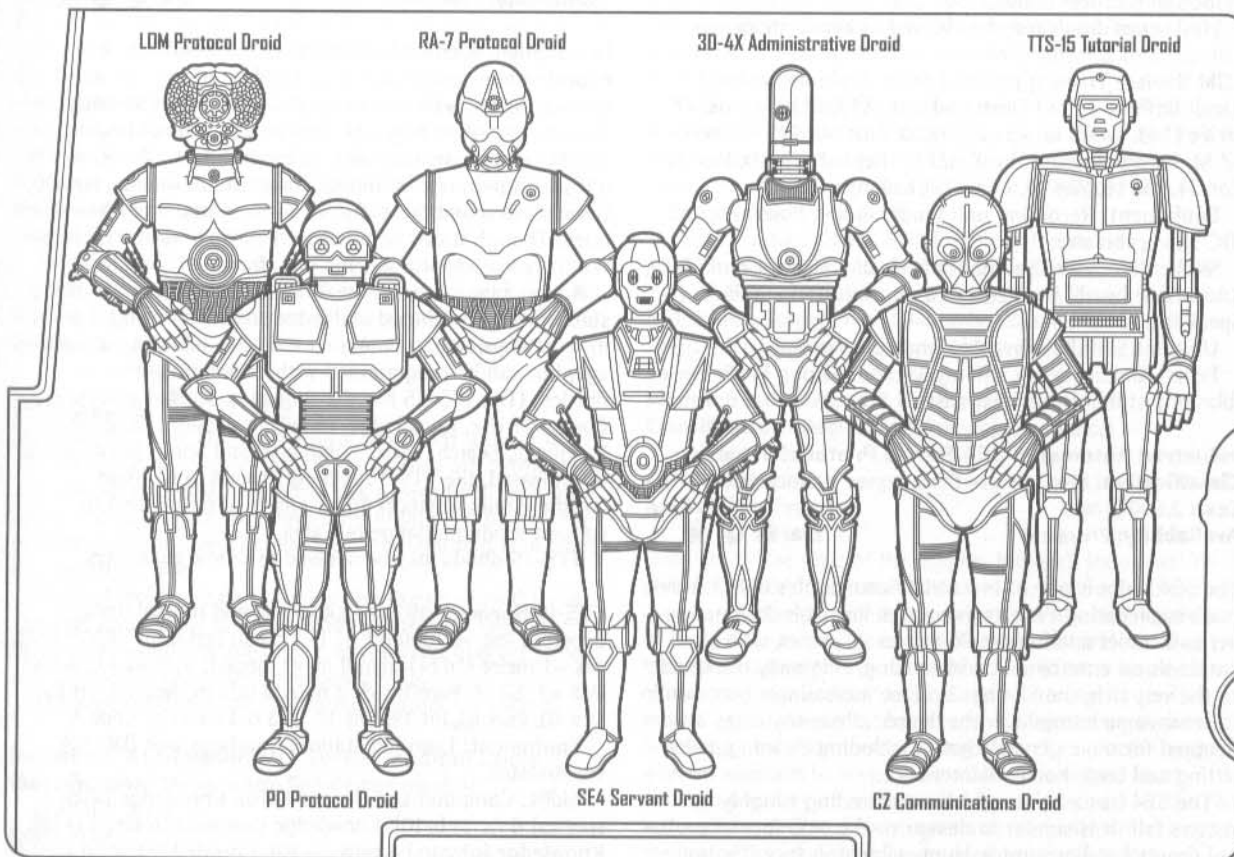

Skills: Bluff 4 ranks (+7), Computer Use 4 ranks (+7), Diplomacy 4 ranks (+7), Knowledge (business) 4 ranks (+7), Knowledge (bureaucracy) 4 ranks (+7), Profession (administrator) 4 ranks (+8), Read/Write Basic, Speak Basic, Speak Binary.

Unspent Skill Points: 4 (3 unused languages).

Feats: Ambidexterity, Skill Emphasis (Profession [administrator]), Weapon Group Proficiencies (blaster pistols, simple weapons).

#### Industrial Automaton LOM Series Protocol Droid

**Classification:** Medium-size third-degree protocol droid

**Cost:** 2,500

**Availability:** Prevalent

**Era:** 

The LOM series of protocol droids was Industrial Automaton's effort to get into the lucrative protocol droid market, long dominated by Cybot Galactica's 3PO series. Looking to open new markets, IA designed the LOM series with an insectoid head, hoping to appeal to races turned off by the Humanlike appearance of the 3PO line. However, IA also wanted to see success in Human markets as well, and as a result the LOM is almost identical to the 3PO series from the neck down, even using many compatible parts. Of course, a lawsuit ensued. To make matters worse, an LOM droid, 4-LOM, went rogue and became a thief and bounty hunter. The series was shut down, but thousands had already been sold.

When working properly, an LOM protocol droid is actually very efficient. It has the same translator units and droid brains as the 3PO series, but IA's programmers managed to avoid the prissy personality that seems to plague most models of protocol droids.

LOM series droids may be allowed as heroic characters.

**LOM Series:** Walking protocol droid, Diplomat 2; Init +1 (Dex); Defense 11 (+1 Dex); Spd 8 m; VP/WP 0/11; Atk +1 melee (1d3, hand) or +2 ranged; SV Fort +0, Ref +1, Will +3; SZ M; Face/Reach 2 m by 2 m/2 m; Rep +1; Str 10, Dex 12, Con 11, Int 15, Wis 10, Cha 12. Challenge Code A.

**Equipment:** Recording unit (audio, holo), translator unit (DC 5), vocabulary.

**Skills:** Computer Use 4 ranks (+6), Diplomacy 4 ranks (+5), Knowledge (world lore) 2 ranks (+4), Read/Write Basic, Speak Basic.

Unspent Skill Points: 20 (2 unused languages).

Feats: Ambidexterity, Infamy, Weapon Group Proficiencies (blaster pistols, simple weapons).

#### Industrial Automaton SE4 Series Protocol Droid

**Classification:** Medium-size third-degree protocol droid

**Cost:** 2,600

**Availability:** Prevalent

**Era:**   

The SE4 series is one of Industrial Automaton's oldest droid models, predating even its astromech line. It is designed to act as a butler and household aid for its owner, with an emphasis on entertaining and cooking. Originally marketed to the very rich, the SE4 has become increasingly common in lower-income homes over the decades. In many cases it is adapted for more general chores, including cleaning, babysitting and basic home maintenance.

The SE4 has a humanoid form, standing roughly 1.6 meters tall. It is similar in design to the 3PO line of protocol droids but has a more Human-looking face (though

the expression is locked in a vacant stare). The SE4 is equipped with a crude translator unit, but generally isn't used for translation tasks except in emergencies. It is equipped with scent and taste analyzers (the taster is located in the droid's right index finger), making SE4s excellent chefs. The SE4's greatest failing may be its personality, which is even more rigid and uptight than that of a typical protocol droid.

SE4 series droids may be allowed as heroic characters.

**SE4 Series:** Walking protocol droid, Diplomat 2; Init +0; Defense 10; Spd 8 m; VP/WP 0/10; Atk +2 melee (1d3+1, hand) or +1 ranged; SV Fort +0, Ref +0, Will +4; SZ M; Face/Reach 2 m by 2 m/2 m; Rep +1; Str 12, Dex 10, Con 10, Int 16, Wis 12, Cha 12. Challenge Code A.

**Equipment:** Sensors (scent analyzer, +2 on Search checks when scent is a factor; taste analyzer, +2 on Search checks when taste is a factor; +2 equipment bonus on Profession (cook) checks), translator unit (DC 20), vocabulary.

**Skills:** Computer Use 3 ranks (+6), Diplomacy 5 ranks (+6), Knowledge (politics) 4 ranks (+7), Profession (cook) 6 ranks (+12), Read/Write Basic, Speak Basic.

Unspent Skill Points: 15 (3 unused languages).

Feats: Ambidexterity, Skill Emphasis (Profession [cook]), Weapon Group Proficiencies (blaster pistols, simple weapons).

#### Industrial Automaton TTS-IS Series Tutorial Droid

**Classification:** Medium-size third-degree educational and tutorial droid

**Cost:** 3,000 (can be leased for 500 credits + 1,000 credits per year)

**Availability:** Prevalent

**Era:**   

Frequently it is either impractical or undesirable to be educated in a formal academy. Children of the rich and famous do not wish to be exposed to constant scrutiny; children in rural areas may not have an educational institution nearby; and adults may wish to expand their education without their ignorance becoming common knowledge. For all these reasons and more, the TTS-15 tutorial droid was developed. Though it can be purchased cheaply, such a droid is normally leased for a specific time frame.

A basic bipedal droid, the TTS-15 has a built-in learning station with a keyboard and video screen, allowing it to instruct anywhere. It comes with a basic educational package, but can be programmed with different courses as needed. (The TTS-15 has the following skills as class skills: Computer Use, Knowledge, Listen, Profession, Read/Write Language, Search, Speak Language, and Spot.) Because it is often leased, the TTS-15 is programmed to be more cowardly than a typical droid, and is often the first to suggest leaving a dangerous area.

TTS-15 droids may be allowed as heroic characters.

**TTS-IS Series:** Walking educational and tutorial droid, Expert 3; Init +0; Defense 11 (+1 class); Spd 6 m; VP/WP 0/10; Atk +1 melee (1d3-1, hand) or +2 ranged; SV Fort +1, Ref +1, Will +3; SZ M; Face/Reach 2 m by 2 m/2 m; Rep +0; Str 8, Dex 10, Con 10, Int 18, Wis 10, Cha 6. Challenge Code A.

**Equipment:** Learning station, translator unit (DC 20), vocabulary.

**Skills:** Computer Use 6 ranks (+10), Knowledge (alien species) 6 ranks (+10), Knowledge (forensics) 6 ranks (+10), Knowledge (physics) 6 ranks (+10), Knowledge (world lore) 6

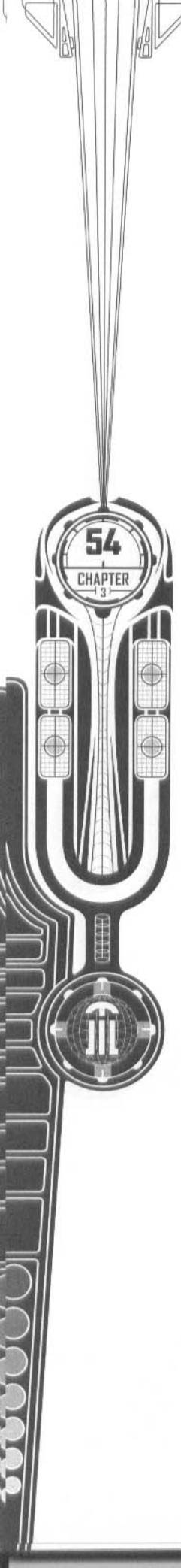

ranks (+10), Profession (tutor) 6 ranks (+9), Read/Write Basic, Speak Language (any three), Speak Basic, Spot 6 ranks (+6).

Unspent Skill Points: 18 (4 unused languages).

Feats: Ambidexterity, Dodge, Skill Emphasis (Profession [tutor]), Weapon Group Proficiencies (blaster pistols, simple weapons).

#### Serv-O-Droid CZ Series Communications Droid

**Classification:** Medium-size third-degree secretary and communications droid

**Cost:** 2,750

**Availability:** Prevalent

**Era:** ⚙️

The CZ series droid was designed to serve as an aid to small businesses and travelers, acting as a mobile communications expert, translator, secretary and secure data storage unit rolled into one. Though long outclassed by the later true protocol and memory storage droids, the CZ series remains useful for individuals who can't afford newer models, or who prefer its less specialized nature.

The data stored on a CZ droid's internal datapad cannot normally be accessed without proper authorization. It is kept in an encrypted format, and any attempt to retrieve it by slicing the data requires a successful Computer Use check opposed by the CZ droid, which receives an additional +5 circumstance bonus on its check for having the information stored in its own memory banks.

CZ series droids may be allowed as heroic characters.

**CZ Series:** Walking secretary and communications droid, Diplomat 4; Init +0; Defense 11 (+1 class); Spd 10 m; VP/WP 0/9; Atk +1 melee (1d3-1, hand) or +2 ranged; SV Fort +0, Ref +1, Will +4; SZ M; Face/Reach 2 m by 2 m/2 m; Rep +1; Str 8, Dex 11, Con 9, Int 12, Wis 10, Cha 12. Challenge Code B.

**Equipment:** Internalized datapad, locked access, multi-ode communications link, translator unit (DC 15).

**Skills:** Bluff 5 ranks (+6), Computer Use 6 ranks (+10), Diplomacy 5 ranks (+6), Knowledge (business) 6 ranks (+10), Profession (secretary) 6 ranks (+6), Read/Write Basic, Sense Motive 5 ranks (+5), Speak Basic.

Unspent Skill Points: 2 (1 unused language).

Feats: Ambidexterity, Skill Emphasis (Computer Use), Skill Emphasis (Knowledge [business]), Weapon Group Proficiencies (blaster pistols, simple weapons).

## Medical Droids

Medical droids are among the most advanced form of droids, and most use first-degree droid brains. They are entrusted with the delicate task of healing sick or wounded biological units, and as a result they have both high levels of training in their craft and deeply embedded programming concerning the sanctity of life.

Medical droids are dedicated to the tasks assigned them. They are remarkably stable, in comparison with the dogged, often headstrong second-degree astromechs, and the nervous, excitable third-degree protocol droids.

The medical droids are illustrated together on page xx.

#### Industrial Automaton MD Series Medical Droid

**Classification:** Medium-size first-degree medical specialist droid

**Cost:** 2,000

**Availability:** Prevalent

**Era:** ⚙️ ⚙️ ⚙️

The MD series droid is among the most common in the galaxy. Though not as skilled or independent as the more popular 2-1B droid it closely resembles, the MD droid is cheaper and more easily specialized, making it popular both with less civilized outposts working under limited budgets and with practicing doctors, who need assistants geared to help with specific procedures. Since the MD is generally kept in a medical bay, it needs very little maintenance, and it can remain functional for a surprisingly long period of time. As a result the MD droid is very widespread and likely to continue to be in use for centuries to come.

Of the several different models of MD droid, the most common are the MD-0 (a diagnostic model), MD-1 (a lab technician model), MD-2 (an anesthesiologist model), MD-3 (a pharmacist model) and MD-4 (a microsurgeon model). Most of these are found in legitimate medical practices, but occasionally one is bought for use as a pirate's private doctor or (especially in the case of MD-2s and MD-3s) keeper of a crime lord's illicit drug stash. The main differences among these models lie in special skill subroutines or specialty tool mounts.

MD series droids may be allowed as heroic characters.

**MD Series:** Walking medical specialist droid, Expert 1; Init +1 (Dex); Defense 11 (+1 Dex); Spd 6 m; VP/WP 0/10; Atk -2 melee (1d3-2, tool), +1 ranged; SV Fort +0, Ref +1, Will +3; SZ M; Face/Reach 2 m by 2 m/2 m; Rep +0; Str 6, Dex 12, Con 10, Int 10, Wis 12, Cha 10. Challenge Code A.

**Equipment:** Breath mask and anesthetic dispenser (MD-2 only), medical diagnostic computer (+4 equipment bonus on Treat Injury checks), medical diagnostic sensors (+2 circumstance bonus on Search and Spot checks; MD-0 only), microsurgery tools (+2 circumstance bonus on Treat Injury checks; MD-4 only), sensors (improved sensors), tool mount (1), vocabulator.

**Skills:** Knowledge (biology) 4 ranks (+4; +7 for MD-1), Knowledge (chemistry) 4 ranks (+4; +7 for MD-2 and MD-3), Profession (doctor) 4 ranks (+5), Read/Write Basic, Speak Basic, Treat Injury 4 ranks (+5; +8 for MD-0 and MD-4).

Unspent Skill Points: 8.

Feats: Ambidexterity, Skill Emphasis (Treat Injury) for MD-0 only, Skill Emphasis (Knowledge [biology]) for MD-1 only, Skill Emphasis (Knowledge [chemistry]) for MD-2 and MD-3 only, Surgery for MD-4 only, Weapon Group Proficiencies (blaster pistols, simple weapons).

#### Medtech Industries FX Series Medical Droid

**Classification:** Medium-size first-degree medical assistant droid

**Cost:** 2,000

**Availability:** Prevalent

**Era:** ⚙️

Obsolete by the time of the Empire, Medtech Industries' FX series of medical assistant droids was once thought the greatest boon to the practice of medicine since the development of bacta. The FX droid stands 1.7 meters tall and sacrifices humanoid appearance in favor of utility. It has a single strong telescoping manipulator and is ringed with twenty tool mount arms that can be equipped with injectors, gas masks, lights, surgical instruments, or anything else a doctor might wish an assistant to keep on hand. Its disk-shaped head contains a variety of sensors spaced evenly around it. The FX is immobile, designed to become a permanent part of a medical office, and must be dragged to new locations.

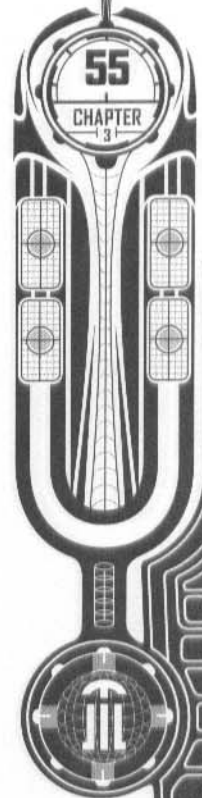

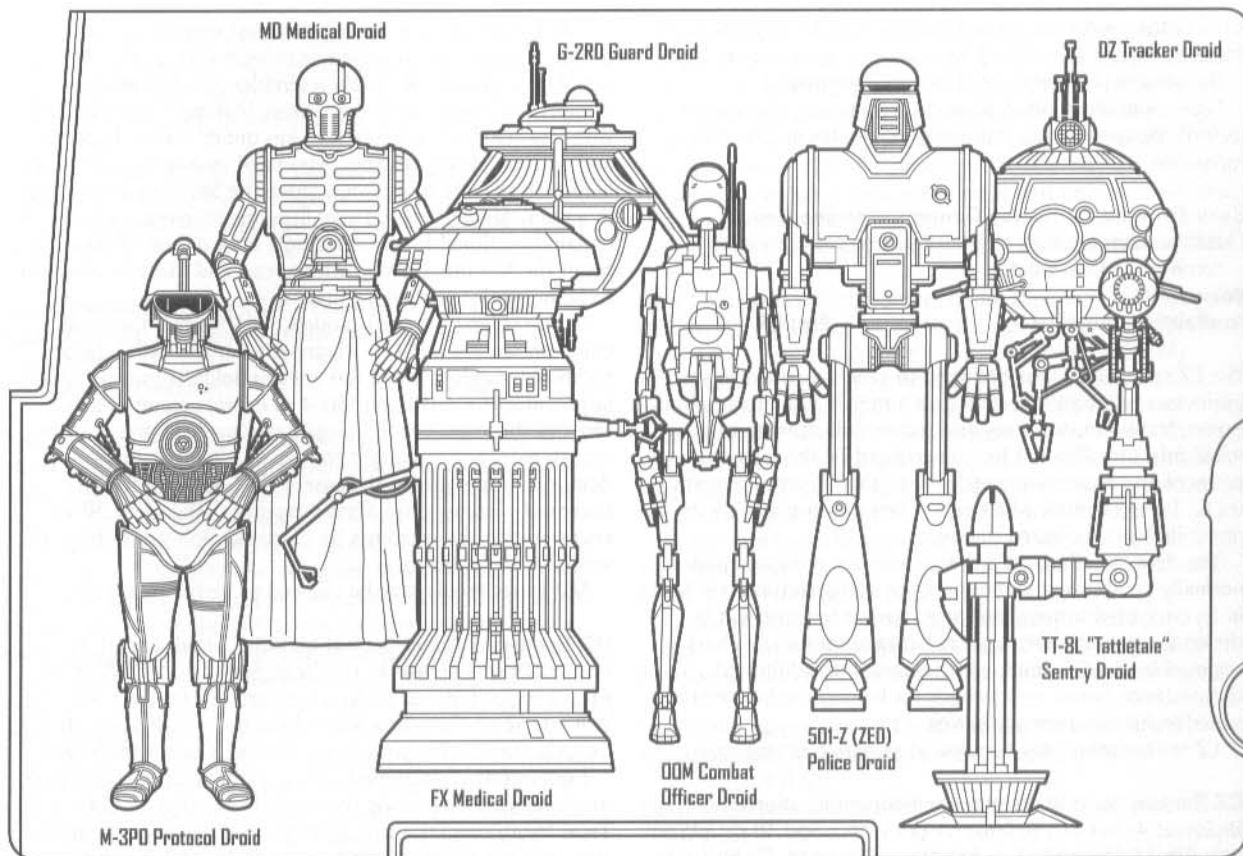

Though the MD and later 2-1B medical droids have displaced the FX from the cutting edge of medical droid technology, the owners of FX droids have few complaints. They are excellent assistants, a good choice for monitoring patients (especially those in bacta tanks), and invaluable aids to doctors performing delicate or complicated operations. The FX is silent, so it doesn't disturb its doctors, but it can display information on a built-in monitor screen or through any connected computer. Many FX droids remain in operation well into the Rebellion era and beyond, especially on Outer Rim worlds and within underfunded organizations.

FX series droids should not be allowed as heroic characters, because they are immobile.

**FX Series:** Stationary medical assistant droid, Expert 1; Init +0; Defense 10; Spd 0 m; VP/WP 0/10; Atk +2 melee (1d3+2, tool) or +0 ranged; SV Fort +0, Ref +0, Will +3; SZ M; Face/Reach 2 m by 2 m/2 m; Rep +0; Str 12, Dex 10, Con 10, Int 10, Wis 12, Cha 6. Challenge Code A.

**Equipment:** Medical diagnostic computer (+2 equipment bonus on Treat Injury checks), sensors (infrared vision, low-light vision, 360-degree vision), telescoping appendage, tool mounts (x20).

**Skills:** Computer Use 4 ranks (+4), Knowledge (biology) 4 ranks (+4), Profession (medic) 4 ranks (+5), Read/Write Basic, Speak Basic (understand only), Speak Binary, Treat Injury 4 ranks (+7).

**Unspent Skill Points:** 8.

**Feats:** Ambidexterity, Surgery, Weapon Group Proficiencies (blaster pistols, simple weapons).

## Military Droids

Most droids are specifically programmed to avoid hurting biological beings, but this is not the case for all of them. Combat droids are built and trained to cause damage, to effectively negate opposition, and even to advise or lead other troops. Military droids usually lack the programming that prevents them from harming biological creatures, and as a result they are viewed with a great deal more suspicion than protocol or astromech droids.

Ownership of military droids is controlled by almost every government; most are restricted to military personnel only, and some are illegal under any circumstance.

Most of the military droids are illustrated together on page xx. The Eradicator and the SD series are illustrated along with other large droids on the last page of this chapter.

### Baktoid Combat Automata OOM Command Officer Series Combat Droid

**Classification:** Medium-size third-degree military leadership droid

**Cost:** 4,500

**Availability:** Prevalent, military

**Era:**

The OOM Command Officer Droid is a slightly more complicated version of the basic remote-operated battle droid (made famous in the Neimoidian blockade of Naboo). It is still completely dependent on orders from a remote location, but is given a more powerful processor and programmed with basic military guidelines, so it can send more detailed information about the course of a battle back to its operators. Though it has no physical differences from the standard



trooper model, it is generally painted with yellow markings for identification.

Similar specialty droids were built using the same processor, and were also painted for identification. The most common of these were blue-marked pilot droids (which replace Knowledge [military] with 3 cross-class ranks in Pilot and the Point Blank Shot feat with either Skill Emphasis (Pilot) or a Starship Operations feat), and red-marked security droids (which replace Knowledge [military] with Knowledge [local] and Point Blank Shot with Alertness).

OOM series droids should not be allowed as heroic characters, since they are remotely controlled.

**OOM Series:** Command officer droid, Thug 3; Init -2 (remote processor); Defense 11 (+1 class); DR 3; Spd 10 m; VP/WP 0/11; Atk +4 melee (1d3+1, hand) or +3 ranged (3d8, blaster carbine); SV Fort +2, Ref +1, Will +1; SZ M; Face/Reach 2 m by 2 m/2 m; Rep +0; Str 12, Dex 10, Con 8, Int 10, Wis 10, Cha 6. Challenge Code A.

**Equipment:** Blaster carbine, internal comlink, light armor, remote receiver, vocabulator, sensors (improved sensor package, telescopic sensors).

**Skills:** Knowledge (tactics) 6 ranks (+7), Read/Write Basic (free), Search 3 ranks (+4), Spot 3 ranks (+3).

**Feats:** Ambidexterity, Point Blank Shot, Toughness, Weapon Group Proficiencies (blaster pistols, blaster rifles, simple weapons).

#### **Balmorran Arms SD Series Infantry Droid**

**Classification:** Large fourth-degree infantry droid

**Cost:** 80,000 (SD-9) or 140,000 (SD-10)

**Availability:** Rare, illegal

**Era:** ☉

The massive SD series infantry droids are among the most dangerous soldiers in the galaxy. Due to their equally massive cost, however, they are also among the rarest. Their design program began during the last days of the Empire, but no working models were produced until after the Battle of Endor. The SD-9 was completed in time to be sold to the New Republic, which was unaware the droid had been built using technology and programming stolen from the Empire's secret Dark Trooper project. When Balmorra fell in the effort to rebuild the Empire, SD-9s were put into use to augment Imperial troops, and the design of the more powerful SD-10 was begun. The Balmorrans had no intention of becoming part of a new Empire, however, and used the new SD-10s to oppose the Imperial occupation.

The SD-9 and SD-10 both stand 3.8 meters tall. They carry small shield generators and internal power supplies, and they have two large weapon mounts, forgoing any manipulating appendages. The SD-10 carries more and heavier weapons, but is also a good deal more costly.

SD-9 and SD-10 series droids should only be allowed as heroic characters in extremely high-level games, and even then their size makes them poor choices.

**SD-9:** Walking infantry droid, Thug 3/Soldier 3; Init +4 (Improved Initiative); Defense 14 (+5 class, -1 size); DR 7; Spd 16 m; VP/WP 25/19; Atk +10/+5 melee (1d6+5, tool) or +5/+0 ranged (4d8, heavy repeating blaster) or +5/+0 ranged (5d10, plasma burst cannon, range increment 100 m); SV Fort +9, Ref +2, Will +1; SZ L; Face/Reach 4 m by 2 m/2 m; Rep +1; Str 20, Dex 10, Con 16, Int 10, Wis 9, Cha 10. Challenge Code D.

**Equipment:** Heavy armor, heavy repeating blasters, locked access, plasma burst cannon, shields (DC 6), weapon mounts (x2).

**Skills:** Listen 6 ranks (+5), Spot 6 ranks (+5), Read/Write Basic, Speak Basic.

**Unspent Skill Points:** 0.

**Feats:** Ambidexterity, Armor Proficiencies (light, medium, heavy), Improved Initiative, Point Blank Shot, Precise Shot, Toughness, Weapon Group Proficiencies (blaster pistols, blaster rifles, heavy weapons, simple weapons, vibro weapons).

**SD-10 Series:** Walking infantry droid, Thug 3/Soldier 6; Init +7 (+3 Dex, +4 Improved Initiative); Defense 18 (+6 class, +3 Dex, -1 size); DR 7; Spd 16 m; VP/WP 53/19; Atk +14/+9 melee (1d6+6, tool) or +11/+6 ranged (4d8, heavy repeating blaster) or +11/+6 ranged (7d10x2, concussion missile launcher, 6 missiles, missile quality +10) or +11/+6 ranged (5d10, plasma burst cannon, range increment 100 m); SV Fort +13, Ref +6, Will +2; SZ L; Rep +2; Str 22, Dex 16, Con 20, Int 10, Wis 9, Cha 10. Challenge Code E.

**Equipment:** Heavy armor, heavy repeating blasters (x2), locked access, plasma burst cannon, sensors (improved sensors), shields (DC 9), vocabulator, weapon mounts (x4).

**Skills:** Knowledge (tactics) 12 ranks (+12), Listen 6 ranks (+7), Spot 6 ranks (+7), Read/Write Basic, Speak Basic.

**Unspent Skill Points:** 0.

**Feats:** Ambidexterity, Armor Proficiencies (light, medium, heavy), Improved Initiative, Far Shot, Point Blank Shot, Precise Shot, Rapid Shot, Toughness, Weapon Group Proficiencies (blaster pistols, blaster rifles, heavy weapons, simple weapons, vibro weapons).

#### **Colicoid Eradicator Series Battle Droid**

**Classification:** Large fourth-degree battle droid

**Cost:** 18,000

**Availability:** Common, military

**Era:** ☉ ☽ ☾

The insectoid Colicoids are best known for building the Droideka series of battle droids, used by the Neimoidians during their blockade of Naboo. However, the Colicoids had designed several combat droid models prior to the Droideka that, while not as well known, are still extremely deadly. All these droids are rare in any era, but the model most often seen is the burly Eradicator droid.

Standing nearly 3 meters tall, these droids are heavily armored bipeds mounting two blaster rifles, two ion cannons (for disabling opposing droid units), and a weak shield, designed to deflect light blaster fire. Unlike the later Droideka series, Eradicators are internally motivated, rather than receiving orders from a remote processor. While this makes the droid more versatile, it remains slow, dumb, and limited to simple combat missions.

When an Eradicator acquires a target, it almost always stops moving and sets down a withering barrage of range fire. When using both blasters and multifiring, it makes its attacks with attack bonuses of +1/+1/-4 with one weapon and +1/+1 with the other. (With the ion rifles, it's +4/-1 and +4.)

Eradicator droids should only be allowed as heroic characters in very high-level campaigns.

**Eradicator Series:** Walking battle droid, Thug 8; Init +2 (Dex); Defense 14 (+3 class, +2 Dex, -1 size); DR 3; Spd 4 m; VP/WP 0/16; Atk +11/+6 melee (1d6+4, tool) or +10/+5 ranged (3d8, light repeating blaster) or +9/+4 ranged

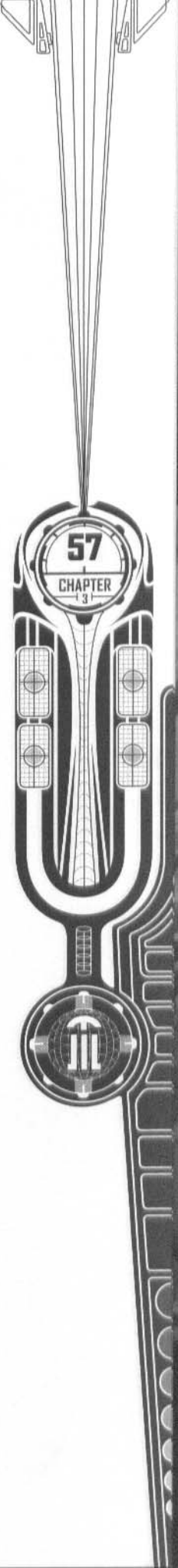

(3d8, ion gun rifle); SV Fort +9, Ref +4, Will +1; SZ L; Face/Reach 4 m by 2 m/2 m; Rep +2; Str 18, Dex 14, Con 16, Int 10, Wis 8, Cha 6. Challenge Code D.

**Equipment:** Light armor, ion gun rifles (x2), light repeating blasters (x2), shields (DR 6).

**Skills:** Listen 5 ranks (+4), Speak Basic (understand only), Spot 6 ranks (+5).

**Unspent Skill Points:** 0.

**Feats:** Ambidexterity, Armor Proficiency (light), Point Blank Shot, Two-Weapon Fighting, Weapon Focus (light repeating blaster), Weapon Group Proficiencies (blaster rifles, simple weapons).

### Cybot Galactica M-3PO Series Protocol Droid

**Classification:** Medium-size third-degree military protocol droid

**Cost:** 4,500

**Availability:** Common, military

**Era:** ⚙️ ⚡️ ⚙️

The great success of the 3PO series led Cybot Galactica to seek new markets for variants of its signature droid. Most of these variant plans were never put into production, but the M-3PO military protocol droid was. In appearance it is similar to standard 3PO models, though it tends to have flat, nonmetallic coloration. The primary difference is the M-3PO's head, a clamshell-like piece containing heavier armor and more memory storage for military files.

The M-3PO is supposed to assist in military bureaucracy, such as the transfer of arms, materials, and men, and it performs those tasks well. Unfortunately, it retains the basic chatter, annoying traits of a typical 3PO droid, and thus is often not very popular with troops or officers. After a fairly small production run, the M-3PO project was scrapped. Many of the units exist centuries later, however, some still seeing service in military groups that need their help no matter how annoying they are. Others have taken up military service themselves after having been abandoned.

M-3PO series droids may be allowed as heroic characters.

**M-3PO Series:** Walking protocol droid, Diplomat 1/Thug 1; Init +2 (Dex); Defense 13 (+1 class, +2 Dex); DR 3; Spd 8 m; VP/WP 0/15; Atk +1 melee (1d3, hand) or +3 ranged; SV Fort +3, Ref +2, Will +2; SZ M; Face/Reach 2 m by 2 m/2 m; Rep +0; Str 10, Dex 14, Con 12, Int 16, Wis 10, Cha 9. Challenge Code A.

**Equipment:** Light armor, recording unit (audio, holo), translator unit (DC 5), vocabulator.

**Skills:** Computer Use 4 ranks (+7), Demolitions 4 ranks (+7), Diplomacy 4 ranks (+3), Knowledge (tactics) 4 ranks (+7), Profession (administrator) 4 ranks (+4), Read/Write Basic, Speak Basic.

**Unspent Skill Points:** 13 (3 unused languages).

**Feats:** Ambidexterity, Toughness, Weapon Group Proficiencies (blaster pistols, simple weapons, slugthrowers, vibro weapons).

## Security and Guard Droids

One of the greatest advantages droids have over biological characters is that they are tireless. Though they must recharge regularly, while operating they do not get bored or grow lax. Droids are excellent choices for duties for which constant, unflinching vigilance is required. Many guard droids are actually better than their biological counterparts for exactly the reason other droids fail at certain tasks—they

lack imagination or creativity. While this lack is a problem in particular for astromech droids (and many of them develop quirks in an effort to gain creativity), the lack of unexpected behavior is a boon in a droid that is supposed to do nothing but wait and watch.

In a similar vein, it is easy to make droids with no loyalty beyond that which is programmed into them, and with no moral compunctions about causing collateral damage. Droids often make excellent trackers and hunters, as well as civilian law enforcement agents.

Security and guard droids generally have third- or fourth-degree brains and circuitry, depending on the extent of social interaction necessary for their jobs.

Most of the security and guard droids are illustrated together on page xx. The GV/3 model is illustrated along with other large droids on the last page of this chapter.

### Arakyd Industries DZ Series Tracker Droid

**Classification:** Small fourth-degree tracker droid

**Cost:** 18,000

**Availability:** Common

**Era:** ⚙️ ⚡️ ⚙️

The DZ series is a small hovering droid with sensors mounted around it and several appendages and weapons hanging beneath its main body. The DZ-70 is the most common droid of this type. It is designed to do just one thing, and do it well—find and apprehend fugitives. It comes factory-set for this purpose, with all its computing power already assigned to tracking functions.

The DZ-70 isn't particularly bright and doesn't cope well with complicated situations. It is best used in controlled settings, such as on prison worlds and transport ships, where it can be given a list of all the fugitives it is to track. When carrying out its tasks in more varied environments (such as those in which many bounty hunters operate), the DZ-70 often becomes confused and grabs the wrong person.

The DZ-70 can talk, though it tends not to say much other than "Do not attempt escape" or a few similar phrases its owner may add. Once it has spotted its prey, the droid takes any action needed to bring its quarry in, including lethal force. As a result, ownership of a DZ-70 by a private citizen is illegal under most governments, although this stricture tends to be ignored on Outer Rim worlds.

DZ series droids should only be allowed as heroic characters in high-level campaigns.

**DZ Series:** Hovering tracker droid, Scout 5; Init +1 (Dex); Defense 16 (+4 class, +1 Dex, +1 size); Spd 10 m; VP/WP 26/10; Atk +4 melee (2d6 or DC 10 stun, electroshock probe) or +5 ranged (3d6, blaster pistol); SQ Trailblazing, heart +1, skill mastery (Spot), extreme effort, uncanny dodge; SV Fort +3, Ref +4, Will +6; SZ S; Face/Reach 2 m by 2 m/2 m; FP 0; Rep +1; Str 10, Dex 12, Con 10, Int 10, Wis 16, Cha 8. Challenge Code C.

**Equipment:** Blaster pistol, comlink, electroshock probe, locked access, repulsorlift unit, sensors (infrared vision, telescopic vision, 360-degree vision), vocabulator.

**Skills:** Computer Use 8 ranks (+8), Hide 8 ranks (+13), Listen 8 ranks (+11), Read/Write Basic, Search 8 ranks (+8), Speak Basic, Spot 8 ranks (+11), Survival 8 ranks (+14).

**Unspent Skill Points:** 0.

**Feats:** Ambidexterity, Point Blank Shot, Skill Emphasis (Survival), Track, Weapon Group Proficiencies (blaster pistols, blaster rifles, simple weapons).

### Arakyd Industries G-2RD Series Guard Droid

**Classification:** Small fourth-degree guard droid

**Cost:** 7,000

**Availability:** Common

**Era:**   

The G-2RD is one of Arakyd's series of spherical, repulsorlift-driven security droids. The G-2RD is flat black in color, with sensor antennae jutting from the bottom, three arms spaced evenly around its body, and a series of eyes dotting its surface. One arm has a manipulating claw, a second is armed with a blaster, and the third sports a stun baton.

G-2RD droids are famous for being tenacious and uncompromising. They are also surly and unpleasant. Arakyd saw this personality as a plus in a guard droid, but it resulted in the unit being unpopular with other droids and living creatures they have to work with. The droid was initially sold to independent prison facilities, but the Empire bought huge numbers of them when it came to power. Millions of the droids were produced, and many remain functional well into The New Jedi Order era in New Republic detention blocks, private security forces, and the occasional petty warlord's army.

G-2RD droids may be allowed as heroic characters.

**G-2RD Series:** Guard droid, Thug 3; Init +2 (Dex); Defense 14 (+1 class, +2 Dex, +1 size); DR 5; Spd 10 m; VP/WP 0/19; Atk +5 melee (DC 15 stun, stun baton), +6 ranged (3d6, blaster pistol); SV Fort +6, Ref +3, Will +2; SZ S; Face/Reach 2 m by 2 m/2 m; Rep +0; Str 12, Dex 14, Con 16, Int 10, Wis 12, Cha 6. Challenge Code A.

**Equipment:** Blaster pistol, comlink, locked access, repulsorlift unit, medium armor, sensors (improved sensors, infrared vision, low-light vision, telescopic vision, 360-degree vision), stun baton, vocabulator, weapon mounts (x2).

**Skills:** Listen 2 ranks (+5), Read/Write Basic, Search 2 ranks (+4), Speak Basic, Spot 2 ranks (+6).

**Unspent Skill Points:** 0.

**Feats:** Ambidexterity, Armor Proficiency (light), Point Blank Shot, Toughness, Weapon Group Proficiencies (blaster pistols, simple weapons).

### Cybot Galactica GV/3 Series Guardian Droid

**Classification:** Medium-size fourth-degree guardian droid

**Cost:** 4,000

**Availability:** Prevalent

**Era:**   

Guardian droids are popular with the wealthy and powerful who wish to protect their children and families living on worlds with large sections of untamed wilderness. Because it was featured in a holo-series, the GV line has become the most popular model of guardian droid. The GV/3 is built like a canine, standing an impressive 1.5 meters tall. It can understand basic commands, but itself communicates only through a series of growls and barks. The GV/3 is equipped with an impressive set of retractable vibro-teeth in its jaws and a concealed blaster pistol built into its chest.

GV series droids may be allowed as heroic characters.

**GV Series:** Walking guardian droid, Thug 4; Init +0; Defense 11 (+2 class, -1 size); Spd 12 m; VP/WP 0/17; Atk +5 melee (2d4+2, vibrodagger bite) or +3 ranged (3d6, blaster pistol); SV Fort +6, Ref +1, Will +1; SZ L; Face/Reach 2 m by 4 m/2 m; Rep +1; Str 14, Dex 11, Con 14, Int 10, Wis 10, Cha 10.

**Equipment:** Concealed blaster pistol, locked access, vibrodagger jaws, vocabulator.

**Skills:** Intimidate 6 ranks (+6), Listen 2 ranks (+4), Speak Basic (understand only), Spot 2 ranks (+4).

**Unspent Skill Points:** 0.

**Feats:** Alertness, Ambidexterity, Point Blank Shot, Toughness, Weapon Group Proficiencies (blaster pistols, vibro weapons).

### Serv-O-Droid TT-8L "Tattletale" Series Guard Droid

**Classification:** Medium-size third-degree sentry droid

**Cost:** 7,000

**Availability:** Prevalent

**Era:**   

The story of the TT-8L series of droids is an example of a market creating a product. Built by Serv-O-Droid for the exclusive and wealthy, the TT-8L droid was meant to be a simple door servant, questioning those who came calling prior to letting them into the owner's abode. Of course, this is a task that a protocol droid or a living assistant (or a simple comlink and remote door opener) could handle, but Serv-O-Droid's advertising campaign stressed the prestige in having a specialty droid for the purpose. Many models of the TT-8L were built with extremely ornate detailing, using expensive metals and intricate scrollwork to enhance their value.

Oddly, the TT-8L droid turned out to actually be useful. It is remarkably bright and often able to tell its owner something about a caller's motives or social status. A demand for less flashy TT-8Ls arose, and many more basic models were developed. Remote processors were added to allow living guards to override a TT-8L and operate it from a security station. Although it became known as the "Tattletale" droid, and was often seen as a sign of great pretentiousness, the TT-8L became increasingly common.

The statistics below represent a basic model; flashier versions have the same abilities but can cost as much as 75,000 credits, and include modifications such as gilding with precious metals, additional sensors, additional levels of diplomat, droid callers, armor, blaster pistols, and in one notable case a flamer (also known as a "Peddler Discourager").

TT-8L droids should not be allowed as heroic characters, because they are immobile.

**TT-8L "Tattletale":** Stationary sentry droid, Diplomat 1; Init +0; Defense 10; Spd 0 m; VP/WP 0/12; Atk +0 melee or +0 ranged; SV Fort +1, Ref +0, Will +5; SZ M; Face/Reach 2 m by 2 m/4 m; Rep +0; Str 10, Dex 10, Con 12, Int 20, Wis 16, Cha 14. Challenge Code A.

**Equipment:** Remote receiver, sensors (improved sensors, low-light vision), vocabulator.

**Skills:** Diplomacy 4 ranks (+6), Knowledge (politics) 4 (+9), Read/Write Basic, Sense Motive 4 ranks (+10), Speak Basic, Spot 4 ranks (+9).

**Unspent Skill Points:** 12 (5 unused languages).

**Feats:** Ambidexterity, Skill Emphasis (Sense Motive), Weapon Group Proficiencies (blaster pistols, simple weapons).

### SoroSuub 50I-Z "Zed" Police Droid

**Classification:** Medium-size third-degree security droid

**Cost:** 15,000

**Availability:** Specialized

**Era:**   

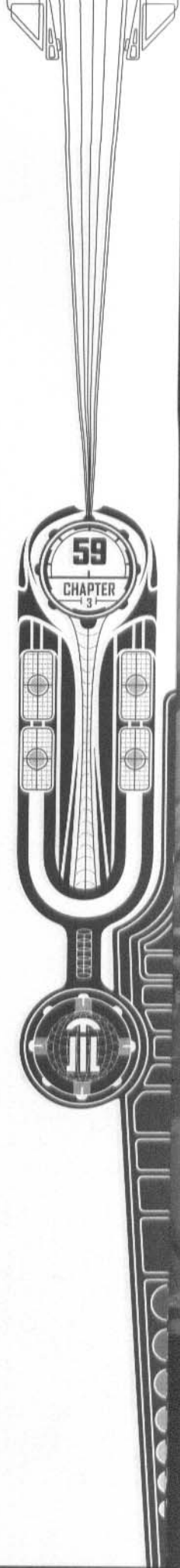

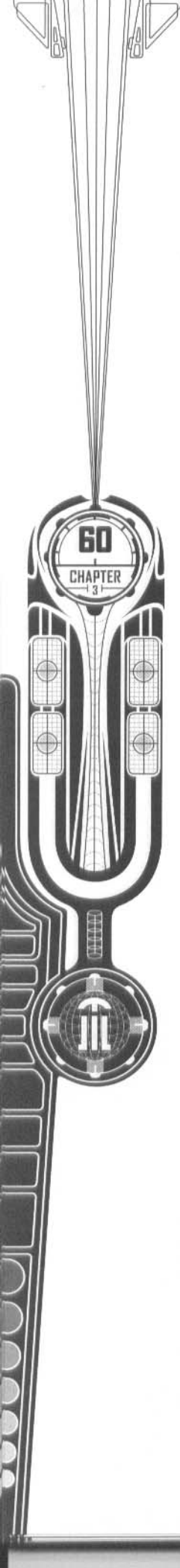

The 501-Z police droid is one of the most remarkable units ever designed by SoroSuub. Physically, it is as tough and imposing as one would expect a police droid to be, standing nearly 2 meters tall and having a powerful crimson bipedal frame. It is their programming that makes 501-Z droids, often called Zeds, so unusual. Rather than being emotionless and uncaring as most security droids are, Zeds are actually both eager and helpful, with a programmed love of the law that is so strong they are the only security model that cannot be reprogrammed to serve as a bodyguard for a criminal. Zeds think of themselves as having universal authority, and they often pursue criminals to great lengths—even to other worlds. Of course, not every government accepts their authority.

Zeds are well equipped for law enforcement, having tough frames that can withstand a great deal of punishment, enhanced sensors, and a holorecording and playback unit that can record crimes in progress or be used to show images of suspects to possible witnesses. Zeds have no built-in weaponry and are typically armed with large macelike stun sticks that essentially function as force pikes—though Zeds rarely use them as lethal weapons. In fact, Zeds never use force that is likely to kill any sentient living creature. They are, however, willing to use what force is needed to disable a criminal's getaway vehicle or an opposing droid, as long as innocent bystanders aren't put at risk.

The Zed series has built-in armor but is also capable of draping humanoid armor on its frame for added protection. A Zed will do so if this increases its ability to capture particularly dangerous felons.

501-Z droids should only be allowed as heroic characters in high-level campaigns.

**501-Z:** Walking police droid, Soldier 5; Init +6 (+2 Dex, +4 improved initiative); Defense 17 (+5 class, +2 Dex); DR 3; Spd 12 m; VP/WP 57/20; Atk +10 melee (2d8+5 or DC 15 stun, force pike) or +7 ranged; SV Fort +9, Ref +3, Will +3; SZ M; Face/Reach 2 m by 2 m/2 m; Rep +1; Str 20, Dex 14, Con 20, Int 12, Wis 14, Cha 12. Challenge Code C.

**Equipment:** Light armor, heuristic processor, locked access, recording unit (holo), sensors (improved sensors, low-light vision), force pike, translator unit (DC 10), vocabulator.

**Skills:** Computer Use 6 ranks (+7), Gather Information 4 ranks (+8), Knowledge (streetwise) 4 ranks (+5), Listen 3 ranks (+7), Profession (law officer) 8 ranks (+10), Read/Write Basic, Speak Basic, Spot 4 ranks (+8).

**Unspent Skills Points:** 0 (1 unused language).

**Feats:** Ambidexterity, Armor Proficiencies (light, medium, heavy), Improved Initiative, Point Blank Shot, Skill Emphasis (Gather Information), Weapon Group Proficiencies (blaster pistols, blaster rifles, heavy weapons, simple weapons, vibro weapons).

## Surveillance and Probe Droids

Surveillance droids are at their heart little more than mobile cameras, usually supported by repulsorlift technology. However, they have their own intelligence and may make their own decisions—choosing to follow their prey, for example. More advanced versions have their own battery of attacks as well, and are capable of attempting to neutralize or destroy their targets in addition to merely stalking them.

Surveillance droids tend to employ fourth- or fifth-degree brains and circuitry. They are usually extremely small, to easily remain hidden.

The surveillance and probe droids are illustrated along with other small droids on the last page of this chapter.

### Arakyd Industries DRK-1 "Dark Eye" Series Probe Droid

**Classification:** Diminutive fourth-degree probe droid

**Cost:** 16,000

**Availability:** Specialized, restricted

**Era:** 

The Arakyd Industries DRK-1, also called Dark Eye, is one of the best surveillance droids ever produced. It's also one of the most expensive and one of the most heavily licensed. The DRK-1, like many Arakyd designs, is a roughly spherical hovering droid with multiple sensor mounts and a retractable antenna. It is covered in a stealth shell that reduces light reflection and energy emissions and muffles sound, making the DRK-1 an extremely quiet droid. According to anecdotal evidence, a DRK-1 can get within 2 meters of a subject without being spotted.

One of the things that makes the DRK-1 so effective is its intelligence. When seeking a target, it taps into comlink communications and seeks out areas to eavesdrop on local informers. When patrolling an area, the DRK-1 seeks points with good visibility and cover, allowing it a clear field of vision without exposing itself. The droid has no respect for privacy and even seems to relish finding secrets, often reporting on interesting goings-on that its owner hadn't asked about.

The DRK-1 features a single weapon mount, which may carry a Small or smaller weapon. This mount is usually used for a launcher holding six frag microgrenades that deal 2d6 points of damage each and have a range increment of 4 m (2 m). A fully loaded launcher costs 2,000 credits in addition to the listed price of the droid and must be replaced when exhausted.

DRK-1 droids may be allowed as heroic characters.

**DRK-1 Series Dark Eye:** Hovering probe droid, Thug 4; Init +5 (Dex); Defense 21 (+2 class, +5 Dex, +4 size); Spd 16 m; VP/WP 0/17; Atk +7 melee (1d6-1, slam) or +13 ranged (2d6 (DC 13), frag microgrenade); SV Fort +6, Ref +6, Will +3; SZ D; Face/Reach 0.5 m by 0.5 m/0 m; Rep +1; Str 8, Dex 20, Con 14, Int 16, Wis 14, Cha 8. Challenge Code B.

**Equipment:** Comlink, imagecaster, locked access, recording unit (audio, holo, video), repulsorlift unit, sensors (360-degree vision, low-light vision, improved sensor package, infrared vision, motion sensors, sonic sensors, telescopic sensors), stealth shell (+2 equipment bonus on Hide and Move Silently checks), weapon mount.

**Skills:** Computer Use 3 ranks (+6), Hide 3 ranks (+22), Listen 3 ranks (+11), Move Silently 3 ranks (+10), Speak Basic (understand only), Speak Binary, Spot 3 ranks (+14).

**Unspent Skill Points:** 5 (3 unused languages).

**Feats:** Alertness, Ambidexterity, Skill Emphasis (Spot), Toughness, Weapon Group Proficiencies (blaster pistols, simple weapons).

### Arakyd Industries Mark VII "Inquisitor" Series Seeker Droid

**Classification:** Diminutive fourth-degree seeker droid

**Cost:** 4,000

**Availability:** Prevalent

**Era:** 

The Mark VII Inquisitor is a seeker droid designed to hunt down a target and return, interrogate, or kill it. It is a

spherical droid no more than 0.2 meters in diameter, but it packs all the tools needed for its task. It carries two weapons that have the same power as blaster pistols, a diverse array of sensors and recording devices, and an advanced data probe that allows it to interface with nearly any computer (and gives a +3 equipment bonus on Computer Use checks).

The Mark VII Inquisitor generally follows its prey from out of sight, often recording its target's conversations. Once it is sure of its prey's identity and has recorded any incriminating actions, the Inquisitor moves in to incapacitate its target. If the seeker droid is supposed to kill its prey, it does so; otherwise it forces its target to a safe location at gunpoint, possibly to begin intense interrogation.

Although seeker droids were rare during the Rise of the Empire era, they became a common Imperial tool. The New Republic uses seekers as well, but requires that they carry nonlethal armament only.

Mark VII Inquisitor droids should only be allowed as heroic characters in high-level campaigns.

**Mark VII Series Inquisitor:** Hovering seeker droid, Thug 8; Init +5 (Dex); Defense 22 (+3 class, +5 Dex, +4 size); Spd 20 m; VP/WP 0/17; Atk +10/+5 melee (1d4-2, slam) or +17/+12 ranged (3d6, blaster pistol); SV Fort +8, Ref +7, Will +5; SZ D; Face/Reach 0.5 m by 0.5 m/0 m; Rep +2; Str 6, Dex 20, Con 14, Int 16, Wis 16, Cha 14. Challenge Code C.

**Equipment:** Comlink, data probe, locked access, recording unit (audio), repulsorlift unit, sensors (infrared vision, improved sensor package, motion sensors, sonic sensors), vocabulator.

**Skills:** Computer Use 4 ranks (+11), Hide 1 rank (+18), Intimidate 11 ranks (+13), Knowledge (biology) 5 ranks (+8), Listen 2 ranks (+11), Move Silently 4 ranks (+9), Read/Write Basic, Speak Basic, Spot 2 ranks (+11), Survival 5 ranks (+11).

**Unspent Skill Points:** 3 (4 unused languages).

**Feats:** Alertness, Ambidexterity, Skill Emphasis (Survival), Toughness, Track, Weapon Group Proficiencies (blaster pistols, simple weapons).

#### Kystallio Detection RMD-20 "Eye in the Sky" Series Monitoring Droid

**Classification:** Diminutive fifth-degree monitoring droid

**Cost:** 2,000

**Availability:** Common

**Era:**  

Sometimes you need to be looking in more than one place at a time. To fill that need, Kystallio Detection created the RMD-20 Eye in the Sky: a small, cheap droid that can follow a particular target, patrol an area, or be guided by orders received through its built-in comlink. Taking the form of a 0.3-meter-diameter sphere with cameras arranged around it, the RMD-20 can project audio signals and video images but has no advanced sensors. It is most commonly found in civilian hands, though particularly frugal police or military units use the RMD-20 as well.

RMD-20 Eye in the Sky droids may be allowed as heroic characters.

**RMD-20 Series Eye in the Sky:** Hovering monitoring droid, Expert 1; Init +2 (Dex); Defense 16 (+2 Dex, +4 size); Spd 10 m; VP/WP 0/6; Atk +1 melee (1d6-3, slam) or +6 ranged; SV Fort -2, Ref +2, Will +2; SZ D; Face/Reach 0.5 m

by 0.5 m/0 m; Rep +0; Str 4, Dex 14, Con 6, Int 8, Wis 10, Cha 8. Challenge Code A.

**Equipment:** Comlink, imagecaster, recording unit (audio, video), repulsorlift unit, sensors (360-degree vision).

**Skills:** Hide 4 ranks (+18), Listen 4 ranks (+4), Move Silently 4 ranks (+6), Search 4 ranks (+3), Speak Basic (understand only), Speak Binary, Spot 4 ranks (+4).

**Unspent Skill Points:** 0.

**Feats:** Alertness, Ambidexterity, Weapon Group Proficiencies (blaster pistols, simple weapons).

## Messenger Droids

Messenger droids are a (relatively) quick and (relatively) secure method of communicating information that an individual might be leery of committing to a holonet transceiver. Loyal and dedicated to its task, a messenger droid will risk its existence in order to carry its message through.

Messenger droids, like surveillance droids, tend to be small, compact units that float on repulsorlifts. They use third-degree brains and circuitry but are not as flighty as many protocol droids.

The messenger droids are illustrated along with other small droids on the last page of this chapter.

#### Arakyd Industries AS-M12 Series Messenger Droid

**Classification:** Tiny third-degree messenger droid

**Cost:** 8,000 (16,000 for 1-shot hyperspace pod)

**Availability:** Prevalent

**Era:**   

When a message has to be delivered quickly, accurately, and secretly, very little does the job as well as a messenger droid. For centuries, the most popular of these has been the Arakyd Industries AS-M12. The AS-M12 messenger droid is a small black sphere with a single large sensor unit and numerous hidden tools (including a telescoping arm for opening doors and a set of computer links that allow it to plug into nearly any computer system). It can be purchased with a 1-shot hyperspace pod that allows the droid to travel to any known location in the galaxy. (When making an Astrogate check for the pod, do not apply any modifier for the location traveled from or traveled to—any location is just as easy for the pod to travel to as any other location.)

Once the pod lands, the AS-M12 seeks out its target, using every effort to remain undetected. When it finds the recipient of its message, the AS-M12 demands a password or some other form of verification. Once satisfied, the droid delivers its message (erasing it from its own memory in the process). Some droids are equipped with a self-destruct to be used at this time, while others go to a predetermined pick-up site, or simply power down, as programmed.

AS-M12 droids should only be allowed as heroic characters in high-level campaigns.

**AS-M12 Series:** Hovering messenger droid, Scout 5; Init +3 (Dex); Defense 19 (+4 class, +3 Dex, +2 size); Spd 10 m; VP/WP 26/10; Atk +1 melee (1d2-2, claw) or +6 ranged; SQ Trailblazing, heart +1, skill mastery (Spot), uncanny dodge, extreme effort; SV Fort +3, Ref +6, Will +4; SZ T; Face/Reach 1 m by 1 m/2 m; Rep +1; Str 6, Dex 16, Con 10, Int 12, Wis 12, Cha 8; Challenge Code C.

**Equipment:** Locked access, repulsorlift unit, sensors (improved sensor package), telescoping appendage.

**Skills:** Computer Use 8 ranks (+12), Hide 8 ranks (+19), Listen 8 ranks (+13), Move Silently 8 ranks (+11), Read/Write

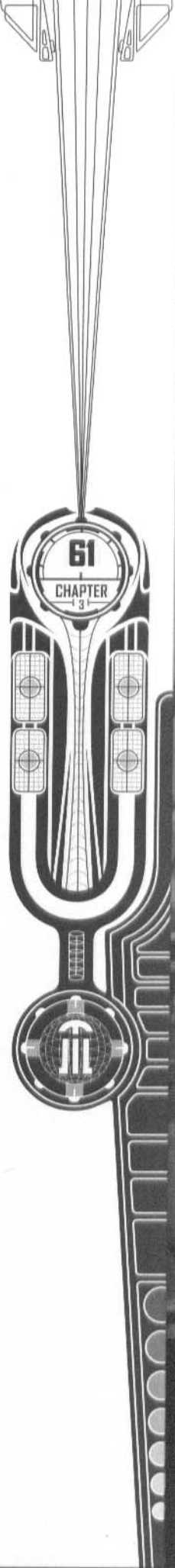

Basic, Search 8 ranks (+11), Speak Basic, Spot 8 ranks (+13), Survival 8 ranks (+9).

Unspent Skill Points: 0 (1 unused language).

Feats: Alertness, Ambidexterity, Skill Emphasis (Computer Use), Track, Weapon Group Proficiencies (blaster pistols, blaster rifles, simple weapons).

#### Cybot Galactica M4 Series Messenger Droid

**Classification:** Diminutive third-degree messenger droid

**Cost:** 4,000

**Availability:** Prevalent

**Era:** 

The M4 Messenger is designed to make a delivery to a specific individual or location. It can record a message, store data, or even carry small objects in a detachable, spring-loaded bay. The M4 droid is generally armed with a small blaster weapon for self-defense, though some municipalities require these be removed. M4s are 0.3 meters tall and lack any limbs or antennae, allowing them to easily slip into small areas. Unlike many hovering droids, the M4 is not round, instead being fairly blocky in appearance with hemispheric sensor nodes on each side and a curved "prow" that protects the droid's internal storage.

M4 Messengers are famous for making their deliveries no matter how long it takes or what damage the droid sustains. In more than one case a military M4 has been destroyed while trying to reach its target in the middle of a firefight, but still successfully hurled its payload with its spring-loaded launcher.

M4 droids may be allowed as heroic characters.

**M4 Series:** Hovering delivery droid, Thug 4; Init +4 (Dex); Defense 20 (+2 class, +4 Dex, +4 size); Spd 16 m; VP/WP 0/17; Atk +8 melee (1d4, slam) or +12 ranged (3d4, sporting blaster pistol); SV Fort +6, Ref +5, Will +2; SZ D; Face/Reach 0.5 m by 0.5 m/0 m; Rep +1; Str 10, Dex 18, Con 14, Int 14, Wis 12, Cha 8. Challenge Code A.

**Equipment:** Internal datapad, internal storage (2 kg, spring-loaded mechanism), locked access, recording unit (audio, holo), repulsorlift unit, sensors (low-light vision, improved sensor package), sporting blaster pistol, vocabulator.

**Skills:** Computer Use 3 ranks (+5), Knowledge (world lore) 7 ranks (+9), Read/Write Basic, Speak Basic, Speak Binary, Spot 3 ranks (+6), Survival 3 ranks (+7).

Unspent Skill Points: 3 (2 unused languages).

Feats: Ambidexterity, Skill Emphasis (Survival), Toughness, Track, Weapon Group Proficiencies (blaster pistols, simple weapons).

## Labor Droids

The primary distinction between labor droids and other household and commercial droids is that labor droids are not designed to assist their owners or give companionship, but instead are set to do a task on their own and only report back when it's done. Usually they function in an industrial setting, or areas too perilous to risk regular Human activity.

Many labor droids have the simplest of droid brains and aren't much smarter than a pet. Others are actually brighter than their more friendly counterparts, able to handle complex situations without going back to their owners for clarification. Most cargo, repair, and industrial droids fall into this category.

Most of the labor droids are illustrated together on page xx. The Binary Load Lifter is illustrated along with other large droids on the last page of this chapter.

#### AccuTronics B1 Series Worker Droid

**Classification:** Medium-size fifth-degree labor droid

**Cost:** 800

**Availability:** Prevalent

**Era:** 

The B1 worker droid is the simplest of droids, designed to do nothing but lift heavy loads and move them. It is a squat design standing 1.5 meters tall, with two powerful legs and a pair of equally strong arms. A third leg can fold out from the droid's body to brace it for picking up particularly heavy or oddly shaped objects, preventing it from tipping over in most cases. The droid's claws are equipped with a series of suction and magnetic clamps, making its grip very secure.

The B1 is capable of taking simple orders, but does not do any advanced thinking on its own. It has no loyalty, taking orders from everyone and anyone who speaks to it, and it cannot be trained to perform different tasks. Despite these limitations, it is a successful droid model. Unthinking obedience and a strong back are precious commodities in many situations.

B1 series droids may be allowed as heroic characters.

**B1 Series:** Walking worker droid, Commoner; Init +0; Defense 10; Spd 6 m; VP/WP 0/10; Atk +10 melee (1d4+10, claw) or +0 ranged; SV Fort +0, Ref +0, Will +0; SZ M; Face/Reach 2 m by 2 m/2 m; Rep +0; Str 30, Dex 10, Con 10, Int 6, Wis 10, Cha 6. Challenge Code A.

**Equipment:** Suction/magnetic tipped claws (+2 on all checks involving lifting and gripping).

**Skills:** Profession (cargo mover) 1 rank (+1).

Unspent Skill Points: 0.

Feats: Ambidexterity.

#### Cybot Galactica CLL-8 Binary Load Lifter Worker Droid

**Classification:** Large fifth-degree worker droid

**Cost:** 2,000

**Availability:** Prevalent

**Era:** 

The Binary Load Lifter is one of the oldest and simplest of all droid designs. It looks remarkably similar to an Imperial AT-ST, only 3 meters tall and carrying two trays. It has no manipulating hands and is covered in cargo support bars. The CLL-8 even carries its own cable, allowing workers to secure unusually large loads to it. The housing of the droid is heavily reinforced to prevent it from being damaged by the large cargoes it is designed to carry.

The CLL-8 can understand Basic, but can only speak in Binary. It is also remarkably literal, resulting in many owners using protocol droids to program the load lifters, thus preventing unfortunate misunderstandings. Despite this drawback, the droid's great strength and low cost makes it a common sight throughout the galaxy.

CLL-8 droids may be allowed as heroic characters, though their single-mindedness and size make them poor choices.

**CLL-8 Binary Load Lifter:** Walking worker droid, Commoner; Init +0; Defense 9 (-1 size); Spd 10 m; VP/WP 0/20; Atk +10 melee (1d6+11, tool) or +0 ranged; SV Fort +5, Ref +0, Will +0; SZ L; Face/Reach 4 m by 2 m/4 m; Rep +0; Str 32, Dex 10, Con 20, Int 10, Wis 10, Cha 6. Challenge Code A.

**Equipment:** None

**Skills:** Profession (cargo mover) 4 ranks (+4).

Unspent Skill Points: 0.

Feats: Ambidexterity.

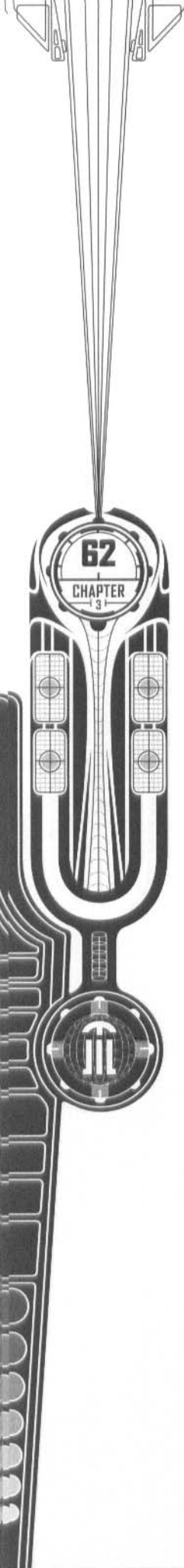

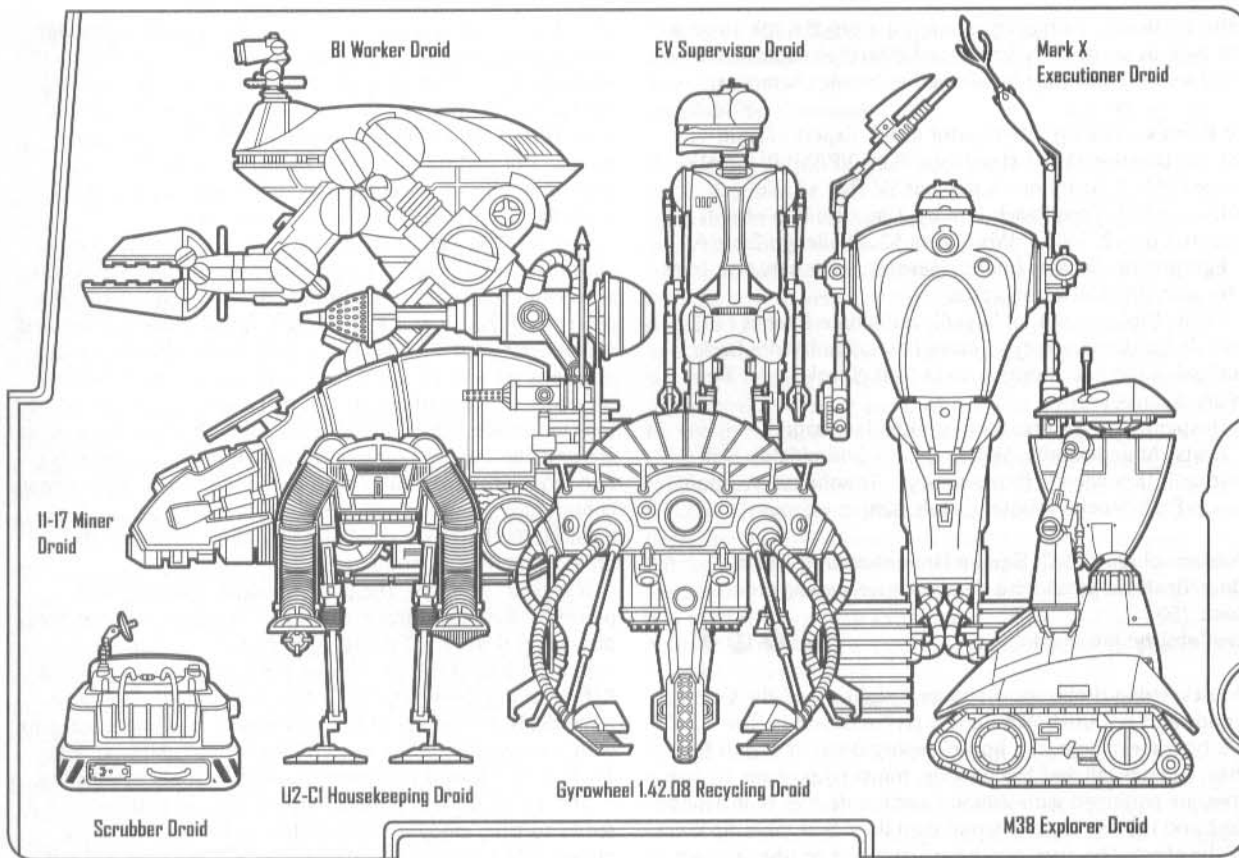

### Industrial Automaton Scrubber Droid

**Classification:** Small fifth-degree hangar maintenance droid

**Cost:** 1,000

**Availability:** Prevalent

**Era:**

Hangars are dangerous places, where volatile fuels and weapons are kept in close proximity to electronics, cutting torches, and powerful engines. Even a small spill of fuel or similar material can cause a fire that rapidly grows into a conflagration of immense proportions. Preventing such disasters is the task of the humble scrubber droid.

The scrubber droid has existed for generations with little or no change. It is essentially a self-motivated box of blast-shielding with vacuum fuel scrubbers, an insulated internal storage tank, and a fire extinguisher. It has a comlink to send and receive information to a central computer, and scent sniffers to help it find the smallest of fuel spills. Most people pay no attention to scrubber droids as long as everything is working smoothly, but the droid is the first thing they look for when a fire starts. Though not particularly bright or friendly, scrubber droids are fearless in the face of even the most dangerous situations. They go to great lengths to put out fires, remove flammable materials, and save anyone overcome by smoke.

Scrubber droids may be allowed as heroic characters.

**Scrubber Droid:** Tracked hangar maintenance droid, Expert 1; Init +2 (Dex); Defense 13 (+2 Dex, +1 size); Spd 10 m; VP/WP 0/20; Atk +0 melee (1d4-1, slam) or +3 ranged; SV Fort +5, Ref +2, Will +1; SZ S; Face/Reach 2 m by 2 m/2 m; Rep +0; Str 8, Dex 14, Con 20, Int 8, Wis 8, Cha 6. Challenge Code A.

**Equipment:** Comlink, environmental compensator (dust, extreme heat, water), fire extinguisher, fuel scrubbers, internal storage (6 kg), rust inhibitor, sensors (sniffers; +2 on Search checks when scent is a factor), telescopic appendage, tool mount.

**Skills:** Demolitions 4 ranks (+3), Knowledge (chemistry) 4 ranks (+3), Read/Write Basic, Search 4 ranks (+6), Speak Basic (understand only), Speak Binary, Spot 4 ranks (+3).

**Unspent Skill Points:** 4.

**Feats:** Ambidexterity, Skill Emphasis (Search), Weapon Group Proficiencies (blaster pistols, simple weapons).

### MarenData EV Series Supervisor/Interrogator Droid

**Classification:** Medium-size fourth-degree supervisor droid

**Cost:** 2,000

**Availability:** Prevalent

**Era:**

The EV series droid was supposed to be simply a mid-management supervisor, overseeing the work of less intelligent droids and possible even living laborers. Though shorter than a typical Human and fairly spindly, the droid has rugged construction to help it survive in factory conditions, where it was expected to carry out most of its tasks. However, the EV series programming was infected with the personality designed for an interrogator droid that was being developed illegally.

As a result, the EV turned out not only to be amoral in its attitude, but to actually enjoy torturing and causing pain. Despite a factory recall and replacement (the V series, which has similar attributes but a more tolerable personality), many EVs have found their way into criminal organizations after being scrapped or abandoned by their initial owners. These

units are usually employed as interrogators, though some are still used as particularly harsh (and effective) supervisors.

EV series droids may be allowed as heroic characters.

**EV Series:** Walking interrogator droid, Expert 1/Thug 1; Init +0; Defense 11 (+1 class); Spd 8 m; VP/WP 0/15; Atk +2 melee (1d3+1, hand) or +1 ranged; SV Fort +3, Ref +0, Will +1; SZ M; Face/Reach 2 m by 2 m/2 m; Rep +0; Str 12, Dex 10, Con 12, Int 18, Wis 8, Cha 12. Challenge Code A.

**Equipment:** Sensors (motion sensors, sonic sensors), translator unit (DC 10), vocabulator.

**Skills:** Diplomacy 4 ranks (+5), Intimidate 5 ranks (+9), Knowledge (bureaucracy) 4 ranks (+11), Read/Write Basic, Profession (administrator) 4 ranks (+3), Speak Basic, Treat Injury 4 ranks (+3).

**Unspent Skill Points:** 25 (4 unused languages).

**Feats:** Ambidexterity, Skill Emphasis (Intimidate), Skill Emphasis (Knowledge [bureaucracy]), Toughness, Weapon Group Proficiencies (blaster pistols, simple weapons).

#### Publictechnic U2-C1 Series Housekeeping Droid

**Classification:** Small third-degree housekeeping droid

**Cost:** 750

**Availability:** Prevalent

**Era:** 

Housekeeping droids are a common sight on all the Core worlds and not unknown on less civilized worlds. The U2-C1 is a typical example of a housekeeping droid. It stands less than 1 meter tall and has a crude, hunched posture. Its two arms are equipped with vacuum suction devices that deposit dust and rubbish in an internal container that takes up most of the chest. The arms also have scrubbing brushes to help with more intense cleaning.

Because they are so common, on many worlds people simply don't notice housekeeping droids. This has led a few enterprising criminals to modify the U2-C1 model to commit theft (by redefining what it considers trash) or assassination (by planting explosives in its internal storage bay). Such efforts are uncommon, however, in no small part because U2-C1 droids tend to be too dull to be trusted with important tasks.

U2-C1 series droids may be allowed as heroic characters.

**U2-C1 Series:** Walking housekeeping droid, Expert 1; Init -1 (Dex); Defense 10 (-1 Dex, +1 size); Spd 6 m; VP/WP 0/12; Atk +1 melee (1d4, slam) or +0 ranged; SV Fort +1, Ref -1, Will +1; SZ S; Face/Reach 2 m by 2 m/2 m; Rep +0; Str 10, Dex 8, Con 12, Int 8, Wis 8, Cha 8. Challenge Code A.

**Equipment:** Environmental compensator (dust), internal storage (6 kg), rust inhibitor, telescopic appendage, vacuum suction limbs (+2 on all grapple checks).

**Skills:** Profession (housekeeper) 4 ranks (+6), Search 4 ranks (+3), Speak Basic, Speak Binary, Spot 4 ranks (+3).

**Unspent Skill Points:** 8.

**Feats:** Ambidexterity, Skill Emphasis (Profession [housekeeper]), Weapon Group Proficiencies (blaster pistols, simple weapons).

#### Roche II-17 Series Mining Droid

**Classification:** Small fifth-degree mining droid

**Cost:** 3,500

**Availability:** Prevalent

**Era:** 

The 11-17 droid was built to perform large jobs—industrial mining and tunneling. Designed generations ago, the 11-17 has held up surprisingly well. It was designed for surviving the harsh conditions of mining operations, and though no more than 1 meter tall and about 1 meter long, it carries more armor plating than most military droids. This armor gives it an almost insectlike look, and some say the 11-17 looks like an oversized mechanical sand tick.

The 11-17 is well equipped for its tasks. It carries a large plasma jet on its back for heavy digging. Smaller, retractable arms can carry other tools, but are normally equipped with a powerful buzzsaw and a blowtorch, for precision cutting and obstacle clearance. It also has a built-in OmniNode communications set and an SW-95 message transceiver, to bounce messages through other 11-17s, if the distance is too far for the OmniNode alone to send a message. (Both of these items are described under Communication Devices in Chapter 5.) The droid can understand both Binary and Basic, but cannot communicate verbally—all messages coming from an 11-17 must be received by a comlink or by direct access to the droid's primitive computer port.

If used as weapons, the buzzsaw deals a base 1d4+1 points of slashing damage as a melee weapon, and the heavy plasma jet deals 3d10 points of energy damage in a beam 6 meters long by 3 meters wide at the terminus. A successful Reflex saving throw (DC 15) halves the damage. The blowtorch deals 2d6 points of energy damage as a melee weapon, with a successful Reflex save (DC15) for half damage. The 11-17 is considered proficient in using its tools as weapons.

The 11-17 droid is popular with miners, in part because it seems to truly enjoy its work. It has to be monitored if a project hits a particularly critical phase, because it will put off recharging to work extra hours. The droid develops a strong loyalty to its owners, and more than one miner has been rescued from a cave-in by the tireless efforts of his 11-17. Sadly, some business managers feel that individual droid brains are a waste of credits, and they push for fully automated remote controlled droid systems. Companies that switch to these systems, however, often find that the heartless machines end up producing less ore, and thus not truly saving money.

11-17 series droids may be allowed as heroic characters.

**II-17 Series:** Tracked mining droid, Expert 3; Init +3 (Dex); Defense 15 (+1 class, +3 Dex, +1 size); DR 3; Spd 10 m; VP/WP 0/18; Atk +7 melee (1d4+4, slam) or +7 melee (1d4+4, saw) or +7 melee (2d6, blowtorch) or +7 ranged (3d10, heavy plasma jet); Fort +5, Ref +4, Will +2; SZ S; Face/Reach 2 m by 2 m/2 m; Rep +0; Str 18, Dex 16, Con 18, Int 12, Wis 8, Cha 12. Challenge Code B.

**Equipment:** Light armor, sensors (improved sensors, infrared vision), tool mounts (x2), environmental compensator (dust, water, vacuum), fusion lanterns, magnetic feet, telescoping appendage.

**Skills:** Climb 6 ranks (+10), Computer Use 1 rank (+2), Knowledge (geography) 6 ranks (+7), Profession (miner) 6 ranks (+8), Search 6 ranks (+9), Speak Basic (understand only), Speak Binary (understand only), Spot 6 ranks (+7).

**Unspent Skill Points:** 11 (1 unused language).

**Feats:** Ambidexterity, Skill Emphasis (Profession [miner]), Weapon Focus (heavy plasma jet), Weapon Group Proficiencies (blaster pistols, simple weapons).



## Other Droids

The advantage of droids is that they may be designed for a specific task or group of tasks, ranging from common labor and maintenance to highly specialized entertainment or security. The following collection of droids showcases the broad spectrum of unique and unusual droid types—those that don't fit into the more common classifications.

Most of the droids presented in this section are illustrated on page xx. The Scarab assassin droid is illustrated along with other small droids on the last page of this chapter, and the Terminax TX is illustrated along with other large droids on the last page of this chapter.

### Arakyd Industries Mark X Executioner Series Gladiatorial Droid

**Classification:** Medium-size fourth-degree gladiatorial droid

**Cost:** 35,000

**Availability:** Specialized, restricted **Era:**   

The popularity of gladiatorial games is one of the dark secrets of the Old Republic. Originally featuring living fighters, the games eventually switched to using droid gladiators—not for moral reasons, but because popular droid fighters could be repaired after taking extreme damage, and thus tended to gather large numbers of fans who would pay to see them fight again.

Gladiatorial games moved out of the Core Worlds eventually, but remained popular in the Outer Rim. The most popular of all gladiatorial droid fighters is the Mark X Executioner. A powerfully built droid with ten weapon mounts and a heavily armored conical body, the Mark X requires heavy treads to move its massive frame. In many arenas Mark Xs are only allowed to fight other Mark Xs, though they are also sometimes used as literal executioners or bodyguards by criminals and corporate leaders in the more lawless areas of the galaxy.

Mark X Executioner droids should only be allowed as heroic characters in high-level campaigns.

**Mark X Executioner Series:** Tracked gladiatorial droid, Soldier 5; Init +2 (Dex); Defense 17 (+5 class, +2 Dex); DR 7; Spd 10 m; VP/WP 32/11; Atk +10 melee (2d10+5, vibro-ax) or +10 melee (2d6+5, vibroblade) or +10 melee (2d8+5, force pike) or +10 melee (2d6+5, spiked club) or +7 ranged (3d8, blaster rifle) or +7 ranged (3d6, flame-thrower, Reflex DC 15 half) or +7 ranged (3d8, ion rifle) or +7 ranged (4d6+1, frag grenade); SV Fort +4, Ref +3, Will +0; SZ M; Face/Reach 2 m by 2 m/2 m; Rep +1; Str 20, Dex 14, Con 11, Int 10, Wis 9, Cha 12. Challenge Code D.

**Equipment:** Heavy armor, locked access, weapon mounts (x10).

**Skills:** Climb 8 ranks (+13), Demolitions 4 ranks (+4), Intimidate 8 ranks (+9), Listen 2 ranks (+1), Read/Write Basic, Spot 2 ranks (+1).

**Unspent Skill Points:** 4.

**Feats:** Ambidexterity, Armor Proficiencies (light, medium, heavy), Cleave, Point Blank Shot, Power Attack, Weapon Group Proficiencies (blaster pistols, blaster rifles, heavy weapons, simple weapons, vibro weapons).

### Les Tech M38 Series Explorer Droid

**Classification:** Medium-size second-degree explorer droid

**Cost:** 10,000

**Availability:** Common

**Era:**   

During the height of hyperspace exploration it was important for pioneers to be able to determine which worlds were really habitable, and which just looked inviting. Frequently the ships that found new worlds had small crews who were experts in astrogation, not scientific analysis. To help these intrepid adventurers, Les Tech designed the M38 Explorer droid, a 1.3-meter-tall droid covered in curved armor plates and sporting a comlink, a holorecorder, and a 5-kilogram specimen hopper. Most important, the M38 is equipped with an internalized sensor pack, with which it can gather details on energy signatures and life forms within 50 meters of itself.

However, the M38 is a high-maintenance droid, requiring calibration after every mission. If an M38 is not maintained regularly, it automatically begins to suffer the effects of disrepair—it is not allowed a saving throw. (See Chapter Fifteen of the *Star Wars Roleplaying Game* for more information on disrepair.) Despite this, the M38 has found a niche in a market other than exploration, often used by military groups to analyze new locations for defensible positions and good headquarter sites.

M38 Explorers may be allowed as heroic characters.

**M38 Series:** Tracked explorer droid, Expert 3; Init +0; Defense 11 (+1 class); DR 3; Spd 8 m; VP/WP 0/20; Atk +5 melee (1d3+3, hand) or +2 ranged; SV Fort +6, Ref +1, Will +5; SZ M; Face/Reach 2 m by 2 m/2 m; Rep +0; Str 16, Dex 10, Con 20, Int 10, Wis 14, Cha 10. Challenge Code B.

**Equipment:** Comlink, light armor, sensors (improved sensors, infrared vision), environmental compensator (cold, dust, heat, vacuum, water), internal storage (5 kg), recording unit (audio, holo).

**Skills:** Climb 6 ranks (+6), Computer Use 6 ranks (+6), Knowledge (geography) 6 ranks (+6), Listen 0 ranks (+6), Read/Write Basic, Speak Basic (understand only), Speak Binary, Search 6 ranks (+11), Spot 6 ranks (+12), Survival 6 ranks (+8).

**Unspent Skill Points:** 0.

**Feats:** Alertness, Ambidexterity, Skill Emphasis (Search), Weapon Group Proficiencies (blaster pistols, simple weapons).

### Merendata Termina TX-III8 Series "Terminax" Assassin Droid

**Classification:** Large fourth-degree assassin droid

**Cost:** 50,000

**Availability:** Rare, restricted

**Era:**   

The Terminax TX series assassin droid was originally designed as a military soldier droid—but no military organization was willing to pay the high price per unit to field an army of them. Desperate to recoup their development costs, MerenData scientists modified the droid brain to include a heuristic processor, and overrode the military ethics they had attempted to hardwire into the brain's design. The resulting droid was perfectly willing to kill whomever it was told to, and able to adapt to the complex and shifting situations common around assassination attempts.

The Terminax TX is a hulk of a droid, standing 2.2 meters tall and covered in armored plate. Though humanoid and

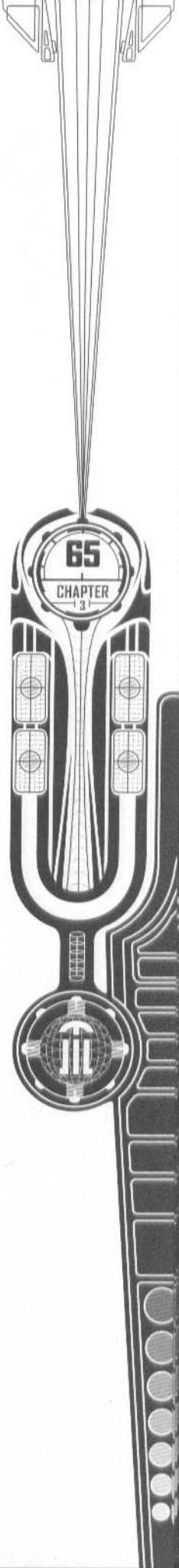

M4 Message Droid

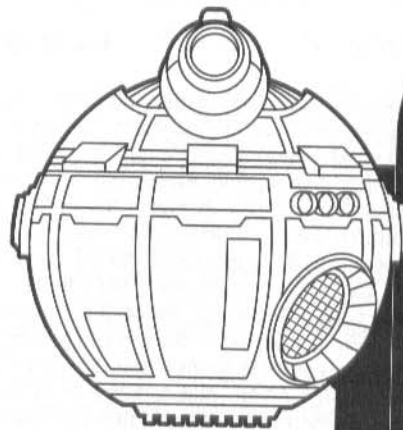

DRK-1 "Dark Eye"

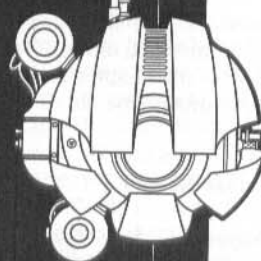

Mark VII Inquisitor Seeker Droid

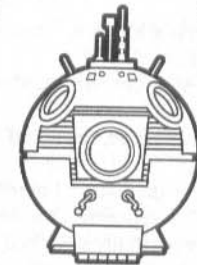
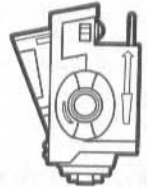
AS-M12  
Messenger Droid

RMD-20 Eye In the Sky



Mark VI Scarab Assassin Droid

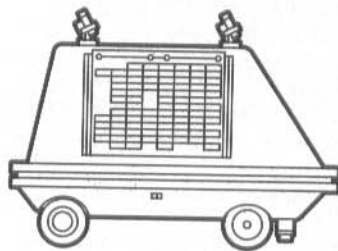

MSE-6 "Mouse Droid"

capable of picking up weapons in the field, it has a built-in blaster rifle in one arm and a frag grenade launcher (equivalent to a SoroSuub TTT-54) in the other, with retractable vibroblades built into both.

If the Terminax TX has a fault, it's that it tends to pick up a personality. This is to be expected, given how complicated its droid brain functions are, and how rare it is for the owner to give it a memory wipe (since a more experienced assassin is a more effective assassin). While some may become philosophical and others gloomy, all Terminax TX droids remain loyal to their owners. Of course, with a transfer in ownership comes a transfer in loyalty.

Terminax TX series droids should only be allowed as heroic characters in high-level campaigns.

**Terminax TX Series:** Walking assassin droid, Soldier 7; Init +1 (Dex); Defense 16 (+6 class, +1 Dex, -1 size); DR 5; Spd 12 m; VP/WP 50/13; Atk +11/+6 melee (2d6+5, vibroblade) or +8/+3 ranged (3d8, blaster cannon) or +7/+2 ranged (4d6+1, frag grenade launcher); SV Fort +6, Ref +3, Will +2; SZ L; Face/Reach 4 m by 2 m/2 m; Rep +2; Str 20, Dex 13, Con 13, Int 10, Wis 10, Cha 18. Challenge Code D.

**Equipment:** Medium armor, blaster cannon, grenade launcher, heuristic processor, locked access, sensors (infrared vision, improved sensors, motion sensors, telescopic sensors), SW-95 message transceiver, retractable vibroblade.

**Skills:** Computer Use 3 ranks (+3), Demolitions 5 ranks (+5), Intimidate 7 ranks (+11), Knowledge (tactics) 7 ranks (+7), Listen 3 ranks (+5), Read/Write Basic, Speak Basic, Spot 3 ranks (+7).

Unspent Skill Points: 2.

**Feats:** Ambidexterity, Armor Proficiencies (light, medium, heavy), Far Shot, Multishot, Point Blank Shot, Precise Shot, Weapon Focus (blaster cannon), Weapon Group Proficiencies (blaster pistols, blaster rifles, heavy weapons, simple weapons, vibro weapons).

#### Sianar Intelligence Systems Mark VI Scarab Series Assassin Droid

**Classification:** Diminutive Fourth-degree assassin droid

**Cost:** 20,000

**Availability:** Illegal

**Era:**

Designed to kill through stealth rather than brute force, the Scarab series of droids became popular during the last days of the Old Republic, often being used by corrupt officials to eliminate political enemies—a practice that did not end with the rise of the Empire.

The Mark VI Scarab appears to be a mechanical insect. Sized to fit in the palm of a Human's hand, it is equipped with six magnetic feet and is extremely light, allowing it to climb vertical metallic surfaces at will. It has a broad set of sensors, including a sniffer that can be programmed to detect any unique biological creature (if a sample of the creature's bodily fluids is available), giving the droid a +4 equipment bonus on all checks to track that one individual.

Numerous different poisons can be loaded into the scarab's injector, but it has enough space for only two total doses of poison. (See Chapter Twelve of the *Star Wars Roleplaying Game* for more about poisons.) Since a single scarab is not always effective, wealthy villains sometimes send a fleet of the little killers against a single target.

Mark VI Scarab droids should not be allowed as heroic characters because of their limited abilities.

**Mark VI Scarab Series:** Walking assassin droid, Thug 4; Init +4 (Dex); Defense 20 (+2 class, +4 Dex, +4 size); Spd 6 m; VP/WP 0/13; Atk +12 melee (1d4-3, injector) or +12 ranged; SQ: Poison; SV Fort +4, Ref +5, Will +1, SZ D; Face/Reach 0.5 m by 0.5 m/0 m; FP 0; Rep +0; Str 4, Dex 18, Con 10, Int 11, Wis 10, Cha 6. Challenge Code C.

**Equipment:** Heuristic processor, locked access, magnetic feet, poison injector, self destruct system, sensors (infrared vision, improved sensor package, motion sensors, pheromone sniffer, sonic sensors).

**Skills:** Climb 3 ranks (+3), Hide 0 ranks (+16), Listen 0 ranks (+4), Move Silently 0 ranks (+16), Spot 0 ranks (+4), Search 0 ranks (+2), Survival 3 ranks (+3).

Unspent skill points: 1.

**Feats:** Ambidexterity, Toughness, Track, Weapon Finesse (injectors), Weapon Group Proficiencies (blaster pistols, simple weapons).

**Veril Line Systems Gyrowheel 1.42.08 Series Recycling Droid**

**Classification:** Small second-degree recycling droid

**Cost:** 2,000

**Availability:** Common

**Era:**   

The gyrowheel line of droids is part of a massive recycling system installed only on ships that are designed to go years between supply restocking, such as a few military

space stations, galactic survey ships, and the occasional pirate vessel. The gyrowheel droid is a simple remote with a single gyro-stabilized wheel, a set of sensors, and two manipulating grippers on the end of telescoping tentacles. The droid patrols its ship or base in constant search of biological refuse, which it takes to a recycling center that can turn out a nearly endless supply of ration bars and protein wafers. The gyrowheel droid takes orders from the computer running the recycling center, which is often the central computer controlling all onboard functions.

Though a gyrowheel droid is fairly inexpensive itself, the recycling center it works with costs 10,000 credits per crew member (150,000 credits, for example, for a ship with a crew of 15).

Gyrowheel 1.42.08 droids should not be allowed as heroic characters, because they lack self-motivation.

**Gyrowheel 1.42.08 Series:** Wheeled recycling droid, Expert 1; Init +3 (+5 Dex, -2 remote processor); Defense 16 (+5 Dex, +1 size); Spd 10 m; VP/WP 0/20; Atk +4 melee (1d4+3, claw) or +6 ranged; SV Fort +5, Ref +5, Will +1; SZ S; Face/Reach 2 m by 2 m/2 m; Rep +0; Str 16, Dex 20, Con 20, Int 8, Wis 8, Cha 6. Challenge Code A.

**Equipment:** Environmental compensator (dust, water), remote receiver, rust inhibitor, sensors (improved sensors), telescopic appendages (x2).

**Skills:** Listen 4 ranks (+7), Search +4 ranks (+5), Spot 4 ranks (+7).

Unspent Skill Points: 8.

**Feats:** Alertness, Ambidexterity, Weapon Group Proficiencies (blaster pistols, simple weapons).

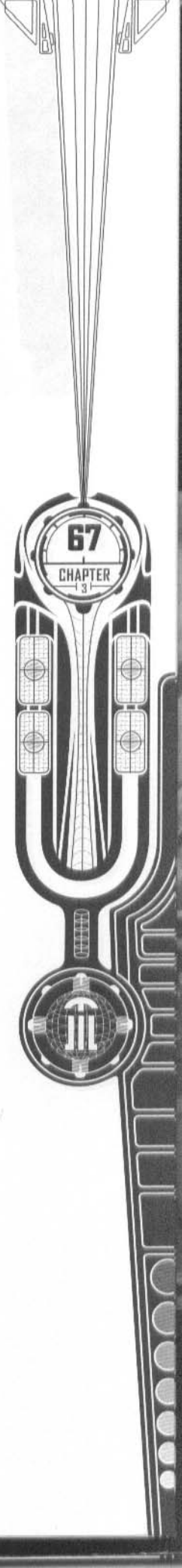
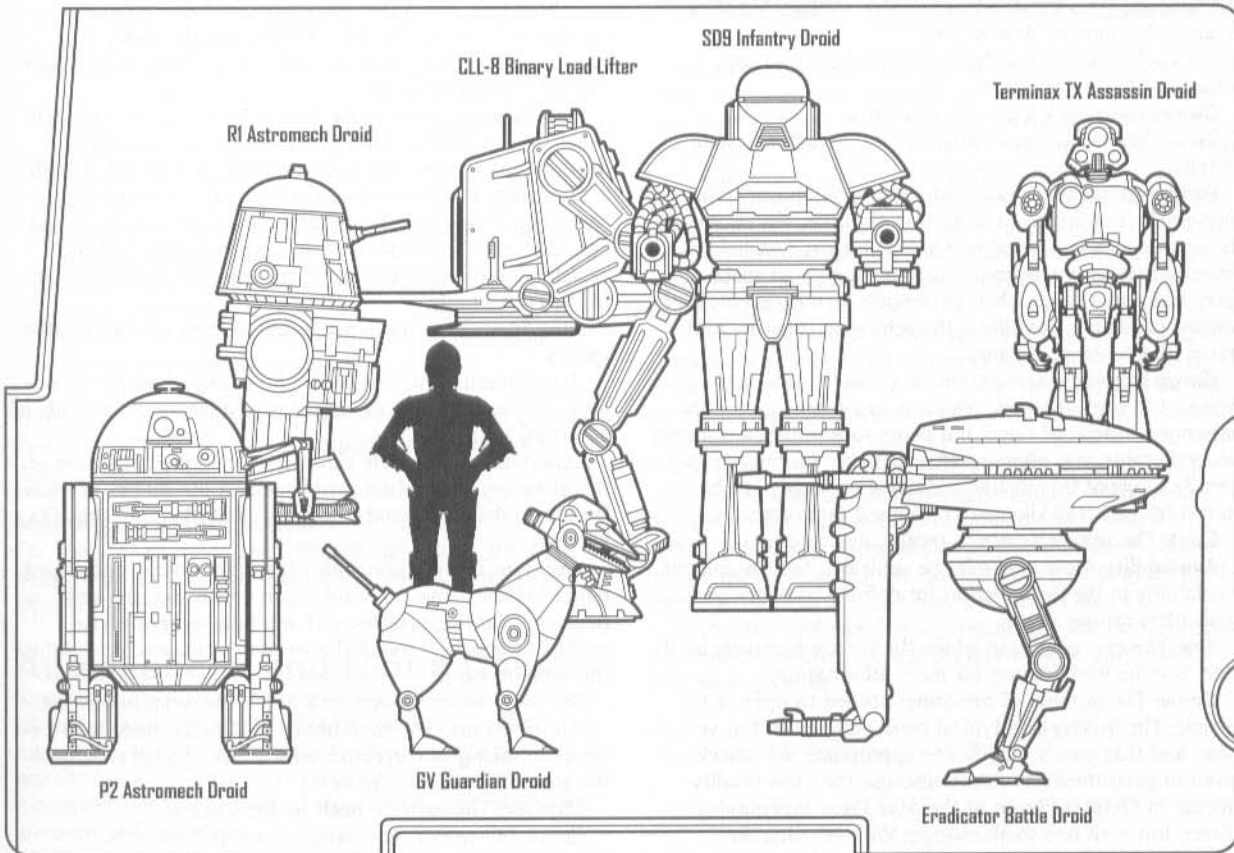



4

VEHICLES

68

CHAPTER

Getting around on a planet's surface or within its cities is just as important as traveling between the stars—even if it doesn't paint as thrilling an image in the action-adventure holovids. Thousands of vehicles are designed to crawl through, fly over, or dive under every conceivable form of planetary landscape. Many are military machines used for patrolling, protecting, or conquering local populations; others are built for little more than thrills. Whatever a hero's transportation needs, everything short of starships is presented here.

The vehicles described in this chapter fall into eight broad categories. First are the dedicated atmospheric vehicles: airspeeders and cloud cars. Then come personal flight devices—gliders, jet packs, and rocket packs—and then speeder bikes and swoops. Following them are groundspeeders, divided into two types: civilian and military. Walkers are covered next, then seacraft (a small but important category), and finally there's a catchall category for vehicles that don't fit any other general description.

Most vehicles are described by a number of attributes, as follows.

- Class:** The vehicle's general category.
- Size:** The vehicle's size category (and its actual size in meters).
- Passengers:** The number of passengers and/or troops the vehicle is designed to carry. This figure is in addition to the crew, which is covered in a separate entry (see below). Vehicles that carry passengers can use passenger space to carry additional cargo when passengers aren't present. Each unused passenger slot allows the vehicle to carry an additional 50 kilograms of cargo.
- Cargo Capacity:** The amount of cargo the vehicle is designed to carry. Many vehicles can, in a pinch, carry extra passengers instead of cargo, but doing so is usually a cramped, uncomfortable, and often unsafe experience for those passengers. As a rule of thumb, one additional passenger can be carried for each 150 kilograms of unused cargo capacity.
- Cost:** The vehicle's price in credits, new and used.
- Availability:** How available the vehicle is. See Equipment Availability in the introduction for definitions of the various availability ratings.
- Era:** The eras of play in which the vehicle is usually available. See the introduction for more information.
- Crew:** The number of personnel needed to operate the vehicle. The quality of a typical crew assigned to this vehicle type, and that crew's modifier to appropriate skill checks, is given in parentheses. (You can also use the Crew Quality sidebar in Chapter Eleven of the *Star Wars Roleplaying Game*, but with one small change: With vehicles, an untrained crew has a check modifier of +0 instead of -4).

- Initiative:** The modifier added to initiative rolls for this vehicle and its typical crew.
- Maneuver:** The modifier added to Pilot checks attempted by this vehicle's typical crew.
- Defense:** The vehicle's Defense. This figure includes the vehicle's size modifier and armor bonus.
- Shield Points:** The vehicle's maximum shield points. Most vehicles don't have shields.
- Hull Points:** The vehicle's maximum hull points. These are the vehicular equivalent of wound points. If the vehicle has damage reduction, it is noted in parentheses.
- Speed or Atmospheric Speed:** Speed (for ground and water vehicles) is the number of meters the vehicle can cover in a move action. If the vehicle uses two move actions, it can move twice this far in a round. A vehicle can also use all-out movement (a full-round action) and move four times its listed speed.

Atmospheric speed (for air vehicles) is the maximum number of 50-meter squares the vehicle can move per action. See Vehicle Movement in Chapter Eleven of the *Star Wars Roleplaying Game*.

- Max Velocity or Altitude:** Max velocity (for ground and water vehicles) is the vehicle's maximum overland speed. Altitude (for air vehicles) is the vehicle's operational altitude.
- Hovering:** The vehicle hovers only, and is not capable of true flight. Hover height for Large or smaller vehicles is typically 2 meters; for larger craft it is typically one-half the vehicle's length. Hover height is measured from the bottom of the craft's body.

- Low:** The vehicle has a maximum altitude of about 1,000 meters.
- Atmospheric:** The vehicle can fly at any atmospheric altitude. On most worlds, this equates to a maximum altitude of about 25 kilometers.

Suborbital: The vehicle can reach the highest outskirts of the planetary atmosphere, just touching the fringes of space. On most inhabited worlds, this is an altitude of 100 to 300 kilometers.

- Weapon:** The weapon with which the vehicle is equipped. (Some vehicles have no weapons, in which case this entry is omitted. Likewise, vehicles with multiple weapons have multiple weapon entries.) The weapon's characteristics follow the weapon name.
- Fire Arc:** The arc or arcs into which the weapon can fire.
- Attack Bonus:** The total bonus on attacks made with the weapon (taking into account vehicle size, typical crew quality, and fire control computer).
- Damage:** The damage dealt by the weapon.
- Range Increment:** The weapon's range increment.

## Customizing Vehicles

Vehicles may be customized in much the same way as weapons (see the start of Chapter 1). They may not be personalized. The number of modifications that may be made to a particular vehicle is determined by its type.

Table 4-1: Vehicle Modification Limits

Weapon	Maximum Customize Modifications	Skill DC to Modify
Airspeeder/cloud car	3	15
Glider/jet pack/rocket pack	1	10
Speeder bike/swoop	3	10
Civilian groundspeeder	4	15
Military groundspeeder	2	20
Walker	2	20
Seacraft	2	15
Other vehicle types	With GM's permission	20

Weapons attached to vehicles may be customized separately, as covered in Chapter 1 of this book. Vehicle weapons may benefit from one customization, may not be personalized, and have a DC of 20 to modify.

### What Can Be Modified

When you modify a vehicle, you can change one of the following attributes.

- ⊕ Increase cargo capacity by 25%. This may be done only once per vehicle.
- ⊕ Increase speed by 25%. This may be done only once per vehicle.
- ⊕ Increase maximum velocity by 25%. This may be done only once per vehicle.
- ⊕ Increase maneuver rating by +1. This may be done only once per vehicle.
- ⊕ Increase Defense by +1. This may be done only once per vehicle.
- ⊕ Increase hull points by +1. This may be done only once per vehicle.
- ⊕ Install an additional weapon. Each weapon counts as a separate modification.
- ⊕ Replace a weapon. Each replacement counts as a separate modification.
- ⊕ Install other equipment. Each piece of equipment counts as a separate modification.

You cannot affect the damage reduction of a vehicle's armor through modification. You can repair damage to a vehicle using the Repair skill.

### Making the Modification

The rules for modifying vehicles are identical to those for modifying weapons. See Making the Modification, at the start of Chapter 1.

## Airspeeders and Cloud Cars

Airspeeders are personal transports that fly as high as 300 kilometers above ground level. Most models have flight ceilings of less than 1 kilometer, however—all that's necessary to provide quick and easy short-distance transportation. Airspeeders are not capable of space travel, and require an atmosphere to function.

### CLOUD JOCKEYS AND SPEEDER ACES

Although the *Star Wars Roleplaying Game* tends to focus on adventures that span the galaxy, many people never leave their home planet. Generally, swoop gang members, Podracers, and cloud car pilots stay on one world or a small set of worlds and don't get involved in the sweeping events in which heroes often find themselves embroiled. This does not mean, however, that they can't become good at their jobs—even amazingly good. There is little difference in skill between an airspeeder ace, with twenty air pirate kills to his name, and a starfighter ace.

To represent this fact, a GM may want to consider expert pilots of atmospheric craft to have many of the advantages of the starfighter ace prestige class, but only with one form of air vehicle. For example, a veteran Beshpin patrol officer could be given two levels of "cloud car ace" (a variation on starfighter ace), providing him with cloud car defense (starship defense applied to cloud cars) and familiarity +1. If the pilot isn't truly heroic, you should limit him to just a few levels, or not give him vitality points.

There is no intrinsic reason why a player character can't be allowed to take these modified prestige classes, but in most campaigns being the galaxy's best V-wing pilot just isn't going to come into play very often. In fact, expertise with atmospheric vehicles is so rarely important that a GM might even consider allowing a starfighter ace hero to add classes of air vehicles to those to which he can apply his class abilities by spending a feat for each additional air vehicle class. ☺

Airspeeders are often viewed as sport and speed vehicles. Many have low cargo capacity and are reserved for races and short journeys. Their sleek, aerodynamic designs can easily reach high speeds, and this attribute, combined with their typically small size, makes them difficult to track with targeting computers. They therefore function superbly as hit-and-run vehicles, making them popular with criminals and terrorist groups. Militias and law enforcement agencies use modified airspeeders as cheap and reliable defense craft.



On large, urbanized planets such as Coruscant and Nar Shaddaa, a different kind of airspeeder is common. Here, airspeeders are the most utilitarian of vehicles; they include common cargo and civilian transport craft as well as faster and more ornate forms.

The term "cloud car" refers to airspeeders designed for medium- to high-altitude planetary defense. Many cloud cars use a combination of ion engine propulsion and repulsorlifts. Despite this general categorization, though, the term has no technical definition—some fast, high-flying airspeeders are referred to as cloud cars, and others aren't.

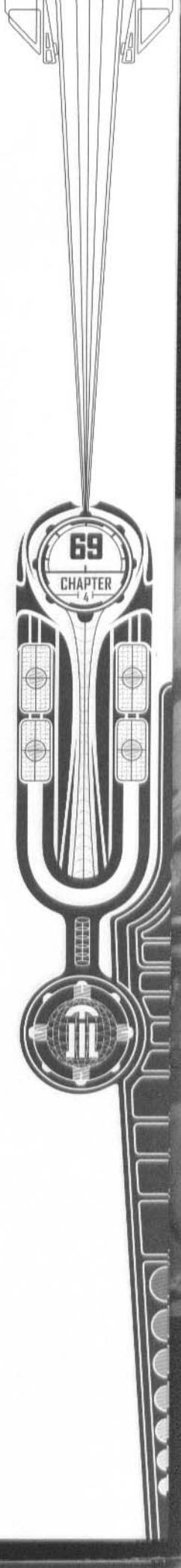
Airspeeders and cloud cars generally use the rules for starship combat, found in Chapter Eleven of the *Star Wars Roleplaying Game*.



### Go-Corp Utilitech Metrocab



**Class:** Airspeeder  
**Size:** Huge (6 m long)  
**Passengers:** 4  
**Cargo Capacity:** 100 kg  
**Cost:** 20,000 (new),  
7,000 (used)  
**Availability:** Prevalent,  
restricted  
**Era:**     
**Crew:** 0 (droid pilot) (Skilled +4)  
**Initiative:** +0 (-4 size, +4 crew)  
**Maneuver:** +0 (-4 size, +4 crew)  
**Defense:** 16\* (-4 size, +10 armor)  
**Shield Points:** 0  
**Hull Points:** 40 (DR 15)  
**Atmospheric Speed:** 2 sq./action  
**Altitude:** Low

\*Provides full cover to passengers.

The Utilitech Metrocab is little more than an air taxi with the simplest of droid brains controlling it. Commercial droid conveyances, also known as robo-hacks, are a common sight in most big cities of the galaxy, and have been for centuries. The Metrocab is fairly typical of these droid taxis, with room for four passengers in an enclosed central cabin, heavy armor plating, and a small forward compartment that stores the droid brain.

When a passenger enters a droid taxi, a mechanical voice asks his destination. There is little other conversation with the droid brain; in fact, the droid taxi is so simple (sporting a fifth-degree brain) that many technicians don't even consider it a droid, preferring the term "automated conveyance." The droid brain has maps and driving instructions for a particular large metropolitan area, and it can be programmed to find the shortest route between any two points (though many greedy owners program the taxi to find the most expensive reasonable route instead). At the end of the trip the droid asks for payment, and it refuses to open the doors (hardness 15, 80 wound points, break DC 35) until it has been paid. The heavy armor plating, installed to prevent swoop gangs from blasting the taxi apart to get its hard-earned credits, also serves to keep passengers inside until they have covered their bill.

### Incom Corporation T-1B Skyhopper

**Class:** Airspeeder  
**Size:** Huge (5.2 m long)  
**Passengers:** 1  
**Cargo Capacity:** 50 kg  
**Cost:** 14,500 (new),  
6,500 (used)  
**Availability:** Prevalent,  
licensed  
**Era:**     
**Crew:** 1 (Normal +2)  
**Initiative:** +0 (-2 size, +2 crew)  
**Maneuver:** +0 (-2 size, +2 crew)  
**Defense:** 12\* (-2 size, +4 armor)  
**Shield Points:** 0  
**Hull Points:** 17 (DR 5)  
**Atmospheric Speed:** 20 sq./action  
**Altitude:** Suborbital

\*Provides three-quarters cover to pilot and passenger.

**Weapons:** Double laser cannon (fire-linked); **Fire Arc:** Front; **Attack Bonus:** +2 (-2 size, +2 crew, +2 fire control); **Damage:** 4d8; **Range Increment:** 200 m.

The Skyhopper is a small, high-speed aircraft used by military units as scouts, local authorities as patrol and police craft, and civilians (including a large number of young people) as hot rods. The craft is popular with planetary pirates and smugglers, in large part because it can outfly most cargo vessels. Skyhopper racing leagues have cropped up on many Outer Rim worlds, especially where Podracing was once popular but has been outlawed.

Civilian models are sold unarmed (for 2,500 credits less, new or used), but the vehicle's weapon mount remains, and it can have other weapons attached to it.

### Slayn & Korpil V-wing

**Class:** Airspeeder  
**Size:** Gargantuan  
(12 m long)  
**Passengers:** 0  
**Cargo Capacity:** 50 kg  
**Cost:** 35,000 (new),  
7,500 (used)  
**Availability:** Specialized,  
military  
**Era:**   
**Crew:** 1 (Skilled +4)  
**Initiative:** +0 (-4 size, +4 crew)  
**Maneuver:** +0 (-4 size, +4 crew)  
**Defense:** 16\* (-4 size, +10 armor)  
**Shield Points:** 0  
**Hull Points:** 80 (DR 10)  
**Atmospheric Speed:** 23 sq./action  
**Altitude:** Suborbital



\*Provides full cover to pilot.

**Weapon:** Double blaster cannon (fire-linked); **Fire Arc:** Front; **Attack Bonus:** +6 (-4 size, +4 crew, +6 fire control); **Damage:** 4d10x2; **Range Increment:** 2,000 m.

The V-wing is a combat speeder designed for use by the New Republic as a replacement for the less versatile cloud car. It has an impressive altitude—rare for a true speeder—which actually allows it to be released in the upper atmosphere of a planet by a transport based on a starship. These transports can carry up to six V-wings at a time, and up to ten transports can be carried aboard a Star Destroyer or similar capital ship. This allows the New Republic to move large numbers of V-wings quickly to defend worlds under attack by starfighters.

The V-wing is lightly armored and carries only two offensive blasters, making it difficult for a V-wing to take on a heavy walker or a true starship. However, the relatively low cost and easy maintenance of the V-wing makes it attractive to the New Republic as a supplement to planetary defenses.

### TaggeCo Cargohopper 102

**Class:** Airspeeder  
**Size:** Huge (5.5 m long)  
**Passengers:** 0  
**Cargo Capacity:** 1,000 kg  
**Cost:** 13,200 (new),  
6,500 (used)  
**Availability:** Prevalent,  
licensed  
**Era:**     
**Crew:** 1 (Normal +2)  
**Initiative:** +0 (-2 size, +2 crew)  
**Maneuver:** +0 (-2 size, +2 crew)  
**Defense:** 11\* (-2 size, +3 armor)  
**Shield Points:** 0  
**Hull Points:** 23 (DR 5)  
**Atmospheric Speed:** 7 sq./action  
**Altitude:** Low

\*Provides no cover to pilot and one-half cover to anything in the cargo bin.

**Weapon:** Cargo claw; **Fire Arc:** Turret; **Attack Bonus:** +4 (-2 size, +2 crew, +8 Str, -4 nonproficiency penalty); **Damage:** 1d6+8; **Range Increment:** 10 m.

**Weapon:** Tractor beam; **Fire Arc:** Turret; **Attack Bonus:** +2 (-2 size, +2 crew, +2 fire control); **Damage:** Special; **Range Increment:** 10 m.

The Cargohopper 102 is a typical small cargo vessel, such as are found in spaceports and warehouses throughout the galaxy. It consists of little more than a pilot's seat in front of a large cargo bin, with a powerful repulsorlift engine mounted beneath both. A vectored turbothrust engine allows the vessel to lift straight up and achieve respectable speeds. However, the Cargohopper has no screen or cover to protect its pilot, since it is designed for short trips of no more than a few kilometers.

Older Cargohoppers are equipped with a cargo claw (Strength 27) able to grab anything directly below the vessel, while more modern versions have a light tractor beam. The tractor beam acts like a starship tractor beam, except that it can be evaded with a Strength check or Escape Artist check (DC 20), and can draw targets 10 meters closer each round.

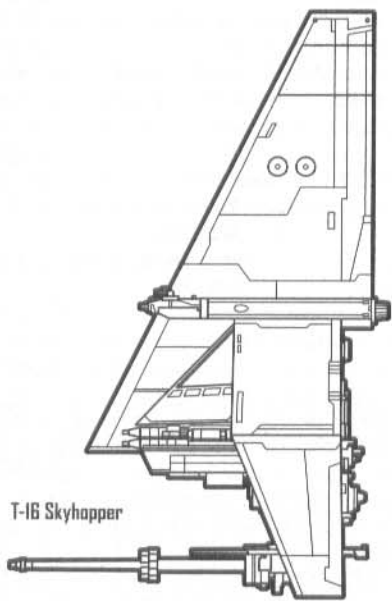

T-16 Skyhopper

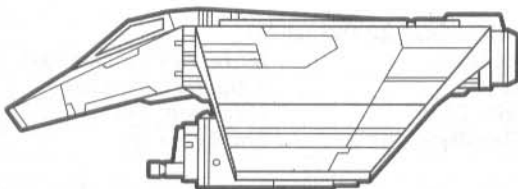

V-Wing Airspeeder

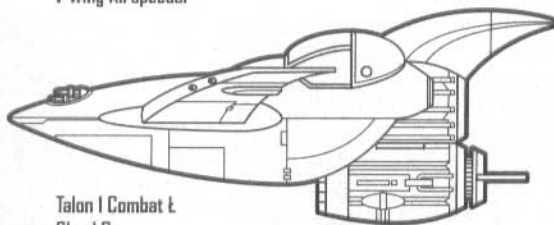

Talon I Combat Cloud Car

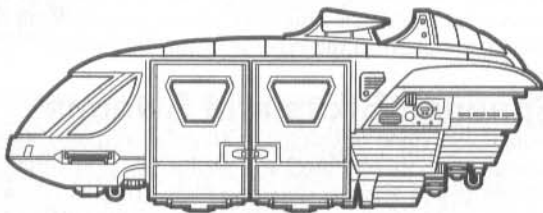

Utilitech Metracab

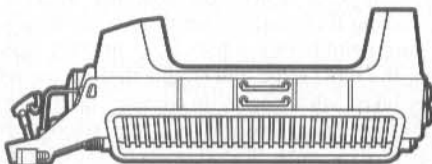

TaggeCo Cargohopper

### Ubrikkian Talon I Combat Cloud Car

**Class:** Airspeeder

**Size:** Huge (8.2 m long)

**Passengers:** 0

**Cargo Capacity:** 10 kg

**Cost:** 15,500 (new),  
7,500 (used)

**Availability:** Prevalent,  
licensed

**Era:**

*\*Provides full cover to pilot.*

**Crew:** 1 (Skilled +4)

**Initiative:** +2 (-2 size, +4 crew)

**Maneuver:** +4 (-2 size, +4 crew,  
+2 maneuvering jets)

**Defense:** 18\* (-2 size, +10 armor)

**Shield Points:** 0

**Hull Points:** 50 (DR 5)

**Atmospheric Speed:** 8 sq./action

**Altitude:** Suborbital

**Weapon:** Double blaster cannon (fire-linked); **Fire Arc:** Front;  
**Attack Bonus:** +4 (-2 size, +4 crew, +2 fire control);  
**Damage:** 5d8; **Range Increment:** 300 m.

Combat cloud cars take the basic cloud car design and modify it for combat with extra armor plating, more powerful engines, and starfighter-quality weapons. They are used throughout the galaxy as upper-atmosphere patrol craft, though they are capable of lower-altitude operations as well. Most can reach altitudes of 100 kilometers and speeds of 1,500 kilometers per hour. They are considerably cheaper to make and maintain than true starfighters, making them a common sight on many high tech worlds.

The Talon I Combat Cloud Car has a single central pod with space for a pilot and little else. It has two airfoils equipped with braking and maneuvering thrusters, making it an extremely nimble craft even at high speeds. It also has a double blaster mounted in the pod's nose. The Talon I has no shields, depending on heavy armor plating and high-speed maneuvers to survive in combat against more powerful craft.

## Gliders, Jetpacks, and Rocket Packs

When all that's needed is transportation for one, sometimes it's better to have a vehicle you strap on rather than climb into. Much of this technology is archaic on any civilized world, but the romance of the Old Republic's rocket-jumper troops—and an ever-present demand from individuals who want to move more silently than a repulsorlift vehicle allows, or want an emergency exit belted onto their back at all times—has kept some models in production.

Full vehicle statistics are not presented for these items, because they're really personal equipment rather than vehicles. These devices either allow their users to fly (following the rules for flying movement found under Creatures in Chapter Fourteen of the *Star Wars Roleplaying Game*) or jump, as detailed in the item's move entry. Jumping with the assistance of one of these items is not treated like a normal jump; the wearer's Strength is irrelevant. No Jump check is necessary—instead, the jump is treated like a short flight that ends after one move action. If the character isn't on a solid surface at the end of his move, he falls. The altitude entry for each item indicates the highest the wearer can jump in a single move.

These vehicles have a maximum load capacity, which includes the weight of the user and any items carried or armor worn, but not the weight of the jump pack itself. Heavier races such as Wookiees tend to avoid such devices as a result. When carrying a load heavier than their maximum, these items do not function.

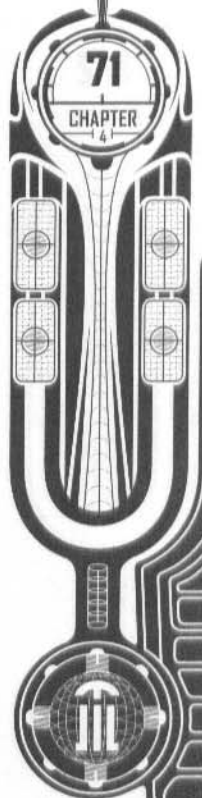

### Aratech "Jumper" Rocket Pack

**Class:** Rocket/Jet pack      **Move:** Jump 100 m  
**Cost:** 500 (100 for fuel cell)      **Altitude:** Low  
**Weight:** 40 kg      **Max Load:** 250 kg  
**Availability:** Rare      **Era:** ☼

The Aratech Jumper is a true rocket pack, carrying a premixed fuel that allows it to operate underwater and in complete vacuum. It is generally controlled by a glove with a thumb trigger, though other controls can be rigged for it as well. Its fuel cell is good for 50 jumps, each taking the wearer up to 100 meters.

Although it is slightly more versatile than comparable jet packs, the Jumper's higher cost and slightly lower endurance has reduced its popularity over the past few centuries.

### Aratech RB2 Jump Boots

**Class:** Rocket/Jet pack      **Move:** Jump 50 m  
**Cost:** 150 (25 for fuel cell)      **Altitude:** Low  
**Weight:** 10 kg      **Max Load:** 150 kg  
**Availability:** Common      **Era:** ☼ ☽ ☾

Jump boots are used primarily in sports games, but explorers and adventurers sometimes employ them as well. They appear to be heavily armored boots that reach to just above the knee. Many models include a long cord that connects to a trigger grip (though some are voice-activated).

Jump boots use a powerful burst of flame to propel the wearer up to 50 meters, and tiny repulsor engines to control flight. The fuel cells in each boot are good for only 5 jumps, but the repulsors can last 100 jumps before their standard energy cells (one in each boot) must be replaced.

### Illisani Aerodyne Hobbycraft Microweight

**Class:** Glider      **Move:** Fly 70 m (poor)  
**Cost:** 500      **Altitude:** Low  
**Weight:** 18 kg      **Max Load:** 150 kg  
**Availability:** Common      **Era:** ☼ ☽ ☾

The microweight is a simple glider that uses a small, quiet repulsorlift engine to provide power, and a set of folding wings with a 4-meter wingspan for control. Microweights are popular sport craft, and many luxury resorts provide rentals in scenic areas such as oceanside cliffs and canyons.

When folded, the Hobbycraft Microweight is the size of a large backpack, and it takes 1 full round to extend or retract the wings. Because it depends upon its repulsor engine for much of its lift, the Hobbycraft can only operate for 1 hour before its standard power pack must be replaced.

### Mitrinomon Z-6 Jetpack

**Class:** Rocket/Jet Pack      **Move:** Jump 100 m  
**Cost:** 300 (100 for fuel cell)      **Altitude:** Low  
**Weight:** 30 kg      **Max Load:** 200 kg  
**Availability:** Rare      **Era:** ☽ ☾

The Z-6 is a well-designed jetpack. It features a large back-mounted engine that is guided either with a wrist control or by voice activation. It uses powerful turbines to suck in air, mix it with fuel, and release it in a three-second burst of flame. This device allows the user to make a short flight of up to 100 meters, easily jumping over most chasms or the tops of nearby buildings.

The Z-6 can make 100 jumps on a full fuel cell. As a jetpack, it depends on a local air supply to create its flame, and so it does not function underwater or in a vacuum. It is also prone to firing when it is struck. While used packs are occasionally available, most serious jet packers don't recommend using them.

### Mobquet OKC-167 Repulsor Pack

**Class:** Repulsor Pack      **Move:** Fly 40 m (perfect)  
**Cost:** 1,800      **Altitude:** Low  
**Weight:** 25 kg      **Max Load:** 200 kg  
**Availability:** Rare      **Era:** ☾

Repulsor packs are a natural extension of more primitive personal flight devices, using modern microrepulsorlifts to grant wingless flight in a device slightly smaller than a typical backpack. Oddly, repulsor packs have never gained the popularity of their more primitive forerunner, the jet pack. Most sport flyers claim they are too slow (though some appreciate their improved maneuverability), and they seem too expensive to appeal to most military units that use flight-pack troops.

In addition to flight, the OKC-167 can be used to hover in place, unlike most other flight packs. However, it operates for only 10 minutes on a set of six standard power packs.

### Nen-Carvon R-23 Paraglider

**Class:** Glider      **Move:** Fly 80 m (average)  
**Cost:** 400      **Altitude:** Atmospheric  
**Weight:** 20 kg      **Max Load:** 240 kg  
**Availability:** Common      **Era:** ☼ ☽ ☾

Paragliders are sturdier and more aerodynamic than microweights, using much smaller repulsorlifts that only assist in takeoffs, landings, and difficult maneuvers. As a result, they have a far higher operational ceiling and can function for nearly indefinite periods of time. Paragliders are popular with more serious recreational flyers.

It's possible to modify a paraglider for military purposes by increasing the strength of its repulsorlift, adding straps for weapons, or covering the wings with sensor-baffling materials (which cause a -5 penalty on any check to detect the paraglider using sensors). All these changes can be made as a single modification for 1,000 credits. Extra sensors such as electrobinoculars are also often added, though doing this costs little more than the expense of the device added.

## Speeder Bikes and Swoops

Though they could technically be classified as groundspeeders or airspeeders, speeder bikes and swoops are more often thought of as a separate class of vehicles. They all follow the same basic design idea—a repulsorlift generator with one or more turbothrust engines, with a seat and some controls attached to them. Such vehicles are generally fast and dangerous, making them equally ideal for sport racing, impressing your neighborhood friends, or military scouting.

In general, the most basic and simple designs are referred to as speeder bikes, while the more complex (and often more stylish) designs are called swoops. As a rule, swoops are faster and more dangerous than speeder bikes, with a much higher maximum altitude. Swoop statistics reflect this, and tend to be more similar to airspeeders and cloud cars than to groundspeeders. Unlike an airspeeder pilot, however, a swoop



rider is exposed to the elements, so that proper protection and breathing masks are recommended.

### Aratech 74-Z Military Speeder Bike

**Class:** Speeder [Ground] **Crew:** 1 (Skilled +4)  
**Size:** Large (4.9 m long) **Initiative:** +3 (-1 size, +4 crew)  
**Passengers:** 1 **Maneuver:** +3 (-1 size, +4 crew)  
**Cargo Capacity:** 4 kg **Defense:** 12\* (-1 size, +3 armor)  
**Cost:** 8,000 (new),  
 3,000 (used) **Shield Points:** 0  
**Availability:** Prevalent, military **Hull Points:** 22 (DR 5)  
**Era:** **Speed:** 150 m  
**Max Velocity:** 360 km/h  
 (6 sq./action)

\*Provides no cover to pilot or passenger.

**Weapon:** Laser cannon; **Fire Arc:** Front; **Attack Bonus:** +7 (-1 size, +4 crew, +4 fire control); **Damage:** 4d8; **Range Increment:** 20 m.

The 74-Z is a basic speeder bike designed for military scouting and urban patrol missions. It consists of a powerful repulsorlift engine with two small thrust engines, a long forward control vein, and a small blaster cannon in a rotating mount. It is designed for a single pilot but has room for a passenger as well—both straddling the engine block of the vehicle. The 74-Z has a maximum ceiling of about 10 meters, typical for most modern speeder bikes.

The 74-Z was the speeder bike of choice for the Empire, which generally deployed them in four-bike "lances." Lances were assigned to scouting or patrol missions, allowing just a few troops to search a large area. Actual combat missions were generally performed by infantry troops backed up by walkers as needed.

### Bespin Motors JR-4 Swoop

**Class:** Airspeeder **Crew:** 1 (Normal +2)  
**Size:** Large (3.9 m long) **Initiative:** +1 (-1 size, +2 crew)  
**Passengers:** 0 **Maneuver:** +1 (-1 size, +2 crew)  
**Cargo Capacity:** 10 kg **Defense:** 14\* (-1 size, +5 armor)  
**Cost:** 9,000 (new),  
 3,000 (used) **Shield Points:** 0  
**Availability:** Common, licensed **Hull Points:** 30 (DR 5)  
**Era:** **Atmospheric Speed:** 480 km/h  
 (8 sq./action) **Altitude:** Low

\*Provides no cover to pilot.

The Bespin JR-4 is one of the earliest personal repulsorlift vehicles, designed during the height of the Old Republic. It would remain popular as a dependable and functional vehicle for centuries, and many remain in service in later eras, despite the fact that production stopped a century before the Empire came to power. The JR-4 has a huge repulsorlift motor that stretches out in front of the pilot's seat, and two powerful turbothrust motors mounted to either side.

The JR-4 was originally advertised as a single-seat airspeeder and was marketed to scouts, explorers, and rich thrill-seekers. It soon became known as a "swoop" because of the high-altitude maneuvers it was often used for, and is believed to be the vehicle for which the term was coined. Though it is much larger and not as fast as more modern swoops, it remains popular among those owners lucky enough to have a functional model.

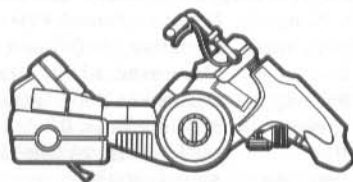

TaggeCo Air-2 Swoop

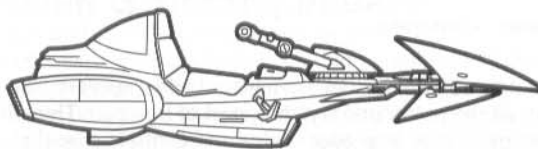

Mobquet Overracer

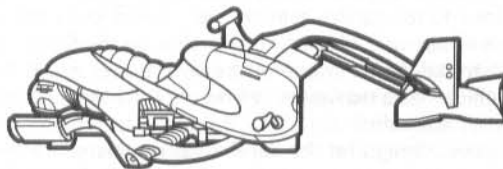

Mobquet Flare-S Swoop

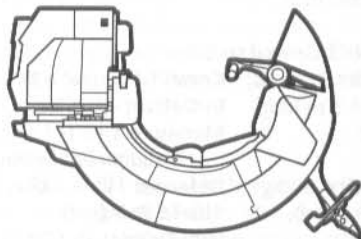

Razalon FC-20 Speeder Bike

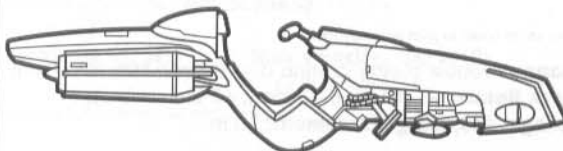

Bespin Motors JR-4

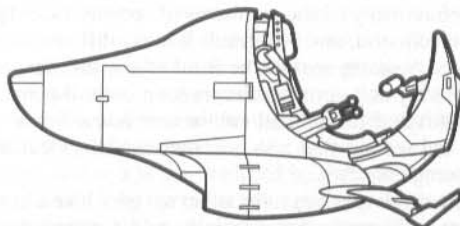

INCOM MVR-3 Speeder Bike

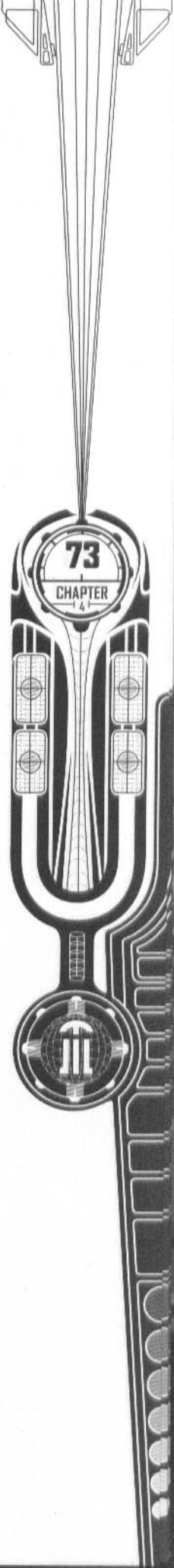

### Ikas-Adno R-2000 Raptor Speeder Bike

**Class:** Speeder [Ground] **Crew:** 1 (Normal +2)  
**Size:** Large (3.9 m long) **Initiative:** +1 (-1 size, +2 crew)  
**Passengers:** 0 **Maneuver:** +1 (-1 size, +2 crew)  
**Cargo Capacity:** 1 kg **Defense:** 11\* (-1 size, +2 armor)  
**Cost:** 10,000 (new)  
7,000 (used) **Shield Points:** 0  
**Hull Points:** 28 (DR 5)  
**Availability:** Prevalent, licensed **Speed:** 200 m  
**Era:**  **Max Velocity:** 480 km/h  
(8 sq./action)

\*Provides no cover to pilot.

The R-2000 Raptor is an attempt to build a speeder bike with all the power and stylish appeal of a swoop. Though it is no more than a speeder engine and control veins, the Raptor manages to stand apart by placing the pilot on the very rear of the vehicle, barely held in place by a safety bar. This has two effects—it allows the speeder to use a larger, more powerful engine the pilot couldn't possibly sit on or near (due to its massive heat exhaust), and it gives the pilot more leverage with his own weight, making the Raptor more easily steered than a swoop of the same power would be. The vehicle has a maximum ceiling of 50 meters, allowing low-level acrobatics.

The basic design for the Raptor was completed during the Empire's reign, but none of the prototypes could be safely driven. A workable design was not created until after the Battle of Endor, and the bikes have enjoyed increasing popularity since that time.

### Incom MVR-3 Speeder Bike

**Class:** Speeder [Ground] **Crew:** 1 (Normal +2)  
**Size:** Large (4.3 m long) **Initiative:** +1 (-1 size, +2 crew)  
**Passengers:** 1 **Maneuver:** +3 (-1 size, +2 crew, +2 equipment bonus)  
**Cargo Capacity:** 50 kg **Defense:** 11\* (-1 size, +2 armor)  
**Cost:** 10,000 (new),  
2,500 (used) **Shield Points:** 0  
**Hull Points:** 25 (DR 5)  
**Availability:** Prevalent, military (licensed if unarmed) **Speed:** 50 m  
**Era:**  **Max Velocity:** 120 km/h  
(2 sq./action)

\*Provides no cover to pilot or passenger.

**Weapon:** Double blaster cannon (fire-linked); **Fire Arc:** Front;  
**Attack Bonus:** +3 (-1 size, +2 crew, +2 fire control);  
**Damage:** 4d8; **Range Increment:** 20 m.

The MVR-3 is an early model of speeder bike popular during the time of the Old Republic, though some examples have survived well into The New Jedi Order era. It was designed before many of the standards of speeder bike style had become common, and as a result it looks different from later speeders. A simple seat at the front of the speeder faces a curved housing that contains the steering control panel. The repulsorlift and turbothrust engines are housed in a large, sleek tail section that also holds most of the electronics and a storage bay.

It is a slower vehicle than most other speeder bikes, but compensates with good maneuverability and a remarkable cargo capacity. The long tail section gives the MVR-3 more stability than a speeder normally manages, granting a +2 equipment bonus on all Pilot checks made with it (this

bonus is included in the statistics above). It has a maximum ceiling of about 50 meters—good for a speeder bike, but nothing compared to a swoop.

Military versions of the MVR-3 have a set of small blaster cannons in the front, but these models were never very popular. (Exclude the blasters from the example above for a civilian MVR-3 and reduce the cost to 7,000 new, 2,000 used.)

### Mobquet Flare-S Swoop

**Class:** Airspeeder **Crew:** 1 (Skilled+4)  
**Size:** Large (2.5 m long) **Initiative:** +3 (-1 size, +4 crew)  
**Passengers:** 1 **Maneuver:** -2 (-1 size, +4 crew, -5 equipment penalty)  
**Cargo Capacity:** 2 kg **Defense:** 10\* (-1 size, +1 armor)  
**Cost:** 6,500 (new),  
2,500 (used) **Shield Points:** 0  
**Hull Points:** 13 (DR 5)  
**Availability:** Prevalent, licensed **Atmospheric Speed:** 600 km/h  
(10 sq./action)  
**Era:**  **Altitude:** Low

\*Provides no cover to pilot or passenger.

The Flare-S swoop is one of the fastest—and most dangerous—of all repulsorlift designs, combining the most powerful features of both swoops and speeder bikes. It has a distinctive S-shaped frame that includes heavy reinforcing to allow the swoop to survive the stress of high-speed maneuvers. The Flare-S is built for speed and little else, with an absolute minimum of safety features (a seat harness) and control surfaces. As a result, this swoop is much faster than most vehicles its size, but very difficult to control (-5 equipment penalty on all Pilot checks; this penalty is included in the statistics above).

The Flare-S is popular with many of the most vicious swoop gangs in urbanized worlds and is sometimes used as a high-speed reconnaissance vehicle by irregular military units and planetary pirates. The Flare-S has a lower maximum altitude than most swoops, but it can still climb higher than the majority of speeder bikes.

### Mobquet OVERRACER Speeder Bike

**Class:** Speeder [Ground] **Crew:** 1 (Normal +2)  
**Size:** Large (4.4 m long) **Initiative:** +1 (-1 size, +2 crew)  
**Passengers:** 0 **Maneuver:** +1 (-1 size, +2 crew)  
**Cargo Capacity:** 4 kg **Defense:** 12\* (-1 size, +3 armor)  
**Cost:** 13,000 (new),  
4,500 (used) **Shield Points:** 0  
**Hull Points:** 14 (DR 5)  
**Availability:** Prevalent, licensed **Speed:** 220 m  
**Era:**  **Max Velocity:** 530 km/h  
(9 sq./action)

\*Provides no cover to pilot.

**Weapon:** Laser cannon; **Fire Arc:** Front; **Attack Bonus:** +5  
(-1 size, +2 crew, +4 fire control); **Damage:** 4d8; **Range Increment:** 20 m.

The OVERRACER is a civilian speeder bike, a rare entry into a field normally dominated by flashier swoops. Though it has an upright seat commonly seen in many swoop designs, the OVERRACER is still little more than an engine and a set of controls. It is popular among more serious speeder racers and is also a common scout vehicle for groups that don't have access to proper military equipment (including the Rebellion).

The Overracer detailed above has a forward-firing laser cannon for "personal defense," but the vehicle may be purchased with an empty mount (10,000 new, 2,500 used). The Overracer has a maximum ceiling of 20 meters.

### Razalon FC-20 Speeder Bike



**Class:** Speeder [Ground] **Crew:** 1 (Normal +2)  
**Size:** Medium-size **Initiative:** +2 (+2 crew)  
 (1.5 m long)  
**Passengers:** 0 **Maneuver:** +4 (+2 crew, +2 equipment bonus)  
**Cargo Capacity:** 2 kg **Defense:** 13\* (+3 armor)  
**Cost:** 4,000 (new), 1,000 (used) **Shield Points:** 0  
**Hull Points:** 18 (DR 5)  
**Availability:** Prevalent, licensed **Speed:** 70 m  
**Era:**  **Max Velocity:** 180 km/h (3 sq./action)

\*Provides no cover to pilot.

The FC-20 is a small, light speeder bike that was popular during the last years of the Old Republic. It uses a small repulsorlift engine that has heavy baffling, making it a very quiet vehicle (-5 penalty on all Listen checks to hear the speeder). It is also unusually shaped, with a U-form body that makes it comfortable to ride and easy to control (+2 on all Pilot checks; this bonus is included in the statistics above). It also rides very low to the ground (usually less than 1 meter in the air), making it a good choice for scouts seeking to follow the nape of the earth. Coupled with the ease of transport of the smaller bike design, the FC-20 is often used as a patrol vehicle that can be carried on larger repulsorlift craft or even scout starships.

All this convenience doesn't come without a tradeoff. The FC-20 is not as fast as some speeder bikes and has a relatively short range, being able to operate no more than 24 hours before requiring a recharge.

### TaggeCo Air-2 Swoop

**Class:** Airspeeder **Crew:** 1 (Normal +2)  
**Size:** Medium-size **Initiative:** +2 (+2 crew)  
 (2.4 m long)  
**Passengers:** 0 **Maneuver:** +0 (+2 crew, -2 equipment penalty)  
**Cargo Capacity:** 4 kg **Defense:** 12\* (+2 armor)  
**Cost:** 6,000 (new), 2,000 (used) **Shield Points:** 0  
**Hull Points:** 15 (DR 5)  
**Availability:** Prevalent, licensed **Atmospheric Speed:** 600 km/h (10 sq./action)  
**Era:**    **Altitude:** Low

\*Provides no cover to pilot.

**Weapon:** Double blaster cannon (fire-linked); **Fire Arc:** Front; **Attack Bonus:** +10 (+4 crew, +6 fire control); **Damage:** 4d10x2; **Range Increment:** 2,000 m.

The Air-2 is a typical swoop design, trading the stability and durability of the speeder bike for pure speed and a solid, stylish design. The Air-2 is a blocky swoop, with the pilot sitting in the center of the vehicle, generally leaning forward. It provides room for a single driver, and an optional duraplast windscreen for drivers who dislike wearing goggles. Though smaller than many similar vehicles, the Air-2's

powerful repulsorlift engine can send it hurtling at impressive speeds to dizzying heights.

The Air-2 can achieve great speed, but it's not easily piloted. It has controls at the handlebars, as well as additional levers at the knee and foot pedals—on top of which the pilot must shift his weight for most maneuvers. As a result, the driver suffers a -2 penalty on all Pilot checks made while operating the swoop, a penalty most individuals are happy to pay as the price for greater speed.





## Civilian Groundspeeders

Groundspeeders are the most common vehicles found on the civilized worlds of the galaxy. Operating on repulsorlift drive technology, they can achieve remarkable speeds. The classification can be somewhat misleading, though; this category includes some rather slow-moving "speeders" as well, such as the Ubrikkian Bantha II cargo skiff.

Most speeders have variable hover heights that change according to their speed. When stopped, they typically hover 1/2 meter or less above the ground, allowing easy access for passengers disembarking or climbing aboard. As they move, they gradually increase their altitude as their speed climbs; most average-sized speeders hover 1 to 2 meters above the ground at cruising speed. Larger groundspeeders move at slightly higher levels; as a rule of thumb, their cruising speed hover height is about one-half the vehicle's length. This gives these vehicles the ability to clear minor obstacles without bouncing the passengers around.

A few models have the ability to fly at higher levels—up to 200 meters above the ground—which blurs the line a bit between groundspeeders and true airspeeders. These exceptions aside, all groundspeeders have an operational altitude of hover (see the vehicle attribute descriptions at the beginning of this chapter).

### Aratach Arrow-23

**Class:** Speeder [Ground] **Crew:** 1 (Normal +2)  
**Size:** Huge (8.1 m long) **Initiative:** +0 (-2 size, +2 crew)  
**Passengers:** 5 **Maneuver:** +0 (-2 size, +2 crew)  
**Cargo Capacity:** 800 kg **Defense:** 13\* (-2 size, +5 armor)  
**Cost:** 10,000 (new), 8,000 (used) **Shield Points:** 0  
**Hull Points:** 60 (DR 10)  
**Availability:** Prevalent, licensed **Speed:** 160 m  
**Era:**     **Max Velocity:** 400 km/h (7 sq./action)

\*Provides full cover to pilot and passengers.

The Arrow-23 is an adventurer's landspeeder, designed to take a small party far from civilization in relative safety and comfort. It's popular with hunters on safari, tour groups in wildlife areas, and campers who want to get far away from the durasteel towers of their jobs in a hurry. The Arrow-23 is a fully enclosed speeder with military-grade armor and blast-resistant windows that can stand up to light blaster cannon fire—but it is also one of the more comfortable and swift civilian speeders available.

Many Arrow-23s are modified by their owners, with such add-ons as a long-range comlink, weapon racks, fold-out sleep benches, and even weapons in manually operated turrets. A luxury model also exists with an all-leather interior and other high-end comfort features, which sells for 10,000 credits more.

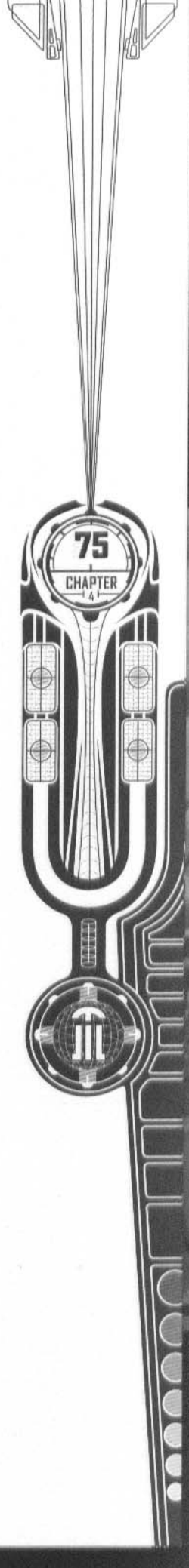

### Borliss Automation Concepts Incorporated HVP-200 Hover Shopper

**Class:** Speeder [Ground] **Crew:** 1 (Untrained +0)  
**Size:** Medium-size **Initiative:** +0  
(2 m long)  
**Passengers:** 0 **Maneuver:** +0  
**Cargo Capacity:** 300 kg **Defense:** 11\* (+1 armor)  
**Cost:** 400 (new), **Shield Points:** 0  
160 (used) **Hull Points:** 20 (DR 5)  
**Availability:** Prevalent, **Speed:** 24 m  
licensed  
**Era:**    **Max Velocity:** 60 km/h  
(1 sq./action)

\*Provides one-quarter cover to pilot.

The HVP-200 is a small, one-person speeder designed for shopping in the big cities and huge market complexes of civilized worlds. It's little more than a comfortable seat and simple controls mounted on a repulsorlift engine, with a secure cargo basket on the back. The HVP-200 is popular with much of the galaxy's middle class, allowing those who can't afford personal shoppers or valet droids to still avoid the press of the crowd and the embarrassment of hauling their purchases by hand.

Some enterprising techs have increased the power of these craft by installing a swoop bike's repulsorlift engine into the chassis. Such vehicles have twice the speed and maximum velocity and an operational altitude of 200 meters, but are difficult to control (-2 on all Pilot checks). These modified speeders are generally more expensive (cost 800), and are often illegal in urban areas.

### Mekuun TR-14a Land Carrier

**Class:** Speeder [Ground] **Crew:** 1 (Skilled +4)  
**Size:** Huge (8.1 m long) **Initiative:** +2 (-2 size, +4 crew)  
**Passengers:** 6 **Maneuver:** +2 (-2 size, +4 crew)  
**Cargo Capacity:** 200 kg **Defense:** 18\* (-2 size, +10 armor)  
**Cost:** 180,000 (new), **Shield Points:** 15  
120,000 (used) **Hull Points:** 50 (DR 15)  
**Availability:** Specialized, **Speed:** 110 m  
licensed  
**Era:**  **Max Velocity:** 270 km/h  
(5 sq./action)



\*Provides one-half cover to pilot and passengers.

Without a doubt the most elegant way to move around has always been the land carrier. Built after the style of ancient wheeled carriages, these incredibly expensive, extremely ornate vehicles are always custom-ordered, with such features as gilded scrollwork, family heraldry, and interior upholstery considered more important than speed or fuel efficiency. Of course, anyone who can afford such a carrier likely considers himself important, so the carrier is also among the most heavily armored nonmilitary vehicles ever designed.

The TR-14a is one of the most popular frames of land carrier Mekuun has ever designed. Each carrier is modified to suit the buyer's specifications, but the basic profile remains the same—a large central passenger compartment is pulled by two stylized turbothrust engines in front and guided by a pilot in an open-air cockpit in back. Small outriggers contain the twin repulsorlift engines that keep the carrier afloat, and considerable storage space exists under the passenger

compartment. Very few individuals can afford such a transport, but planetary monarchs, crime lords of major families, and ultrarich dilettantes have always managed to find the money for real luxury.

### Mobquet A-1 Deluxe Floater

**Class:** Speeder [Ground] **Crew:** 1 (Normal +2)  
**Size:** Huge (7.1 m long) **Initiative:** +0 (-2 size, +2 crew)  
**Passengers:** 1 **Maneuver:** +0 (-2 size, +2 crew)  
**Cargo Capacity:** 10 kg **Defense:** 11\* (-2 size, +3 armor)  
**Cost:** 30,500 (new), **Shield Points:** 0  
8,250 (used) **Hull Points:** 20 (DR 5)  
**Availability:** Prevalent, **Speed:** 70 m  
licensed  
**Era:**    **Max Velocity:** 160 km/h  
(3 sq./action)

\*Provides three-quarters cover to pilot and passengers.

The A-1 Deluxe Floater defined the affordable luxury speeder for over a hundred years. Designed with a fully enclosed canopy, Corellian leather interiors, and simple but elegant lines, it is the favored transport on many worlds where airspeeders aren't needed but most land speeders are too utilitarian. Sometimes in service for generations, many are reduced to little more than junk after long years of use, and sell for far less than new—but many years after the discontinuation of the line, the vehicle remains highly regarded, and a pristine A-1 could actually bring a price of 50,000 credits or more from a collector.



### SoroSuub JG-8 Luxury Speeder

**Class:** Speeder [Ground] **Crew:** 1 (Normal +2)  
**Size:** Huge (6.2 m long) **Initiative:** +0 (-2 size, +2 crew)  
**Passengers:** 1 **Maneuver:** +0 (-2 size, +2 crew)  
**Cargo Capacity:** 20 kg **Defense:** 11\* (-2 size, +3 armor)  
**Cost:** 40,000 (new), **Shield Points:** 0  
20,500 (used) **Hull Points:** 25 (DR 5)  
**Availability:** Prevalent, **Speed:** 180 m  
licensed  
**Era:**  **Max Velocity:** 450 km/h  
(8 sq./action)

\*Provides one-half cover to pilot and passenger.

The JG-8 is a high-priced speeder designed for style over ability. It seats two in a long, thin open-air central passenger compartment, with two ornate steering veins in the front of the speeder and two turbothrust engines mounted at the rear. The JG-8 was most popular during the glory days of the Old Republic, but remains a symbol of wealth and prestige in any era.

### SoroSuub V-35 Courier

**Class:** Speeder [Ground] **Crew:** 1 (Untrained +0)  
**Size:** Large (3.8 m long) **Initiative:** -1 (-1 size, +0 crew)  
**Passengers:** 2 **Maneuver:** -1 (-1 size, +0 crew)  
**Cargo Capacity:** 120 kg **Defense:** 11\* (-1 size, +2 armor)  
**Cost:** 6,500 (new), **Shield Points:** 0  
1,500 (used) **Hull Points:** 18 (DR 5)  
**Availability:** Prevalent, **Speed:** 50 m  
licensed  
**Era:**    **Max Velocity:** 120 km/h  
(2 sq./action)

\*Provides one-quarter cover to pilot and three-quarters cover to passengers.

The most common form of landspeeder is the simple family model used for transportation around town and between cities. The V-35 Courier is one such model, with an enclosed passenger compartment in the front, an open pilot's seat mounted on the top for high visibility, and a repulsor field generator set in an easy-access housing. The Courier has enough speed and cargo capacity for most tasks a common citizen expects of it, and is cheap enough for lower-class families to afford. It's designed to be easily repaired, which makes it popular on harsh worlds where landspeeders tend to break down regularly.

**SoroSuub XP-38 Sport Landspeeder**

**Class:** Speeder [Ground] **Crew:** 1 (Untrained +0)  
**Size:** Large (3.5 m long) **Initiative:** -1 (-1 size, +0 crew)  
**Passengers:** 1 **Maneuver:** -1 (-1 size, +0 crew)  
**Cargo Capacity:** 30 kg **Defense:** 11\* (-1 size, +2 armor)  
**Cost:** 12,500 (new), 3,500 (used) **Shield Points:** 0  
**Availability:** Prevalent, licensed **Hull Points:** 16 (DR 5)  
**Era:** ☉ **Speed:** 150 m  
**Max Velocity:** 370 km/h (6 sq./action)

\*Provides one-half cover to pilot and passenger.

One of the largest commercial landspeeder markets is for high-speed vehicles designed for performance rather than durability. Although often referred to as sport models, these speeders are not truly meant for professional racing, but for more casual recreational activities.

The XP-38 is a sport landspeeder introduced in the latter years of the Empire. Featuring a snug two-person cockpit, fully retractable duraplast windscreen, and starfighterlike control design, it is clearly targeted at a younger audience. Its excellent cornering ability makes it popular for street races, but the speeder's repulsor field does not handle rough terrain well. The XP-38 gives its driver a +2 bonus on all Pilot checks when on a flat, smooth surface, but a -2 penalty when over rough terrain.

**TaggeCo SCS-19 Sentinel**

**Class:** Speeder [Ground] **Crew:** 1 (Skilled +4)  
**Size:** Gargantuan (12 m long) **Initiative:** +0 (-4 size, +4 crew)  
**Passengers:** 4 **Maneuver:** +0 (-4 size, +4 crew)  
**Cargo Capacity:** 50 kg **Defense:** 15\* (-4 size, +9 armor)  
**Cost:** 60,000 (new), 40,000 (used) **Shield Points:** 15  
**Availability:** Prevalent, licensed **Hull Points:** 30 (DR 10)  
**Era:** ☉ ☽ ☾ **Speed:** 200 m  
**Max Velocity:** 480 km/h (8 sq./action)

\*Provides full cover to pilot and passengers.

**Weapon:** Double blaster cannon (fire-linked); **Fire Arc:** Front;  
**Attack Bonus:** +6 (-2 size, +4 crew, +4 fire control);  
**Damage:** 4d10; **Range Increment:** 200 m.

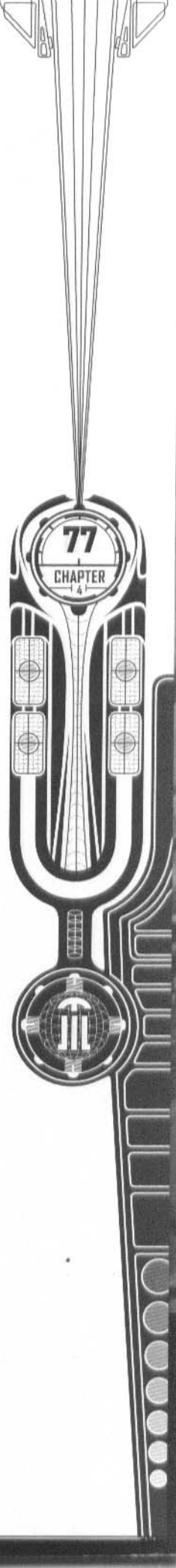
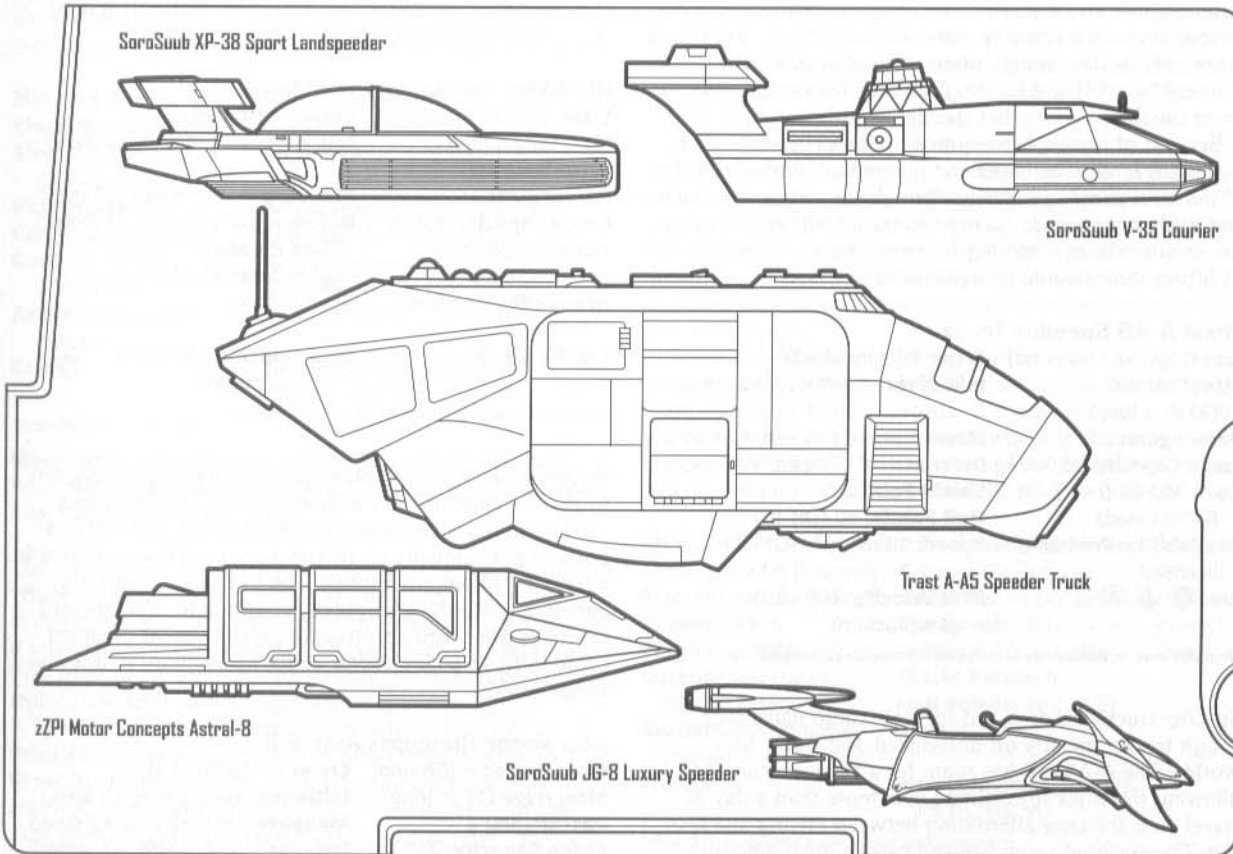

The SCS-19 Sentinel is an armored transport used for moving valuable cargo and as a personal conveyance for the wealthy and worried. It is a fully enclosed speeder with



an impressive set of repulsorlift engines (including complete redundancy—even if one engine fails, the Sentinel is still mobile), angled armor plating, and a set of forward-mounted blasters (for defensive use only, of course). The Sentinel even has a set of weak shields modeled after starship shields. Of course all this security comes at a price, and the Sentinel is about as expensive as a small starfighter.

Though the Sentinel might seem perfect for military use, it is too expensive for most military organizations to afford, and it doesn't have the firepower to act as an assault vehicle or the cargo capacity to be a transport. It is most popular with crime lords, corporate executives, and holovid stars who have more money than they know what to do with.

#### Tion Industries Hyperfoil 1000-XTC



**Class:** Speeder [Ground] **Crew:** 1 (Normal +2)  
**Size:** Huge (7 m long) **Initiative:** +0 (-2 size, +2 crew)  
**Passengers:** 2 **Maneuver:** +0 (-2 size, +2 crew)  
**Cargo Capacity:** 100 kg **Defense:** 11\* (-2 size, +3 armor)  
**Cost:** 12,500 (new), **Shield Points:** 0  
 7,500 (used) **Hull Points:** 20 (DR 10)  
**Availability:** Common, **Speed:** 120 m  
 licensed  
**Era:**   **Max Velocity:** 300 km/h  
 (5 sq./action)

*\*Provides one-half cover to pilot and passengers.*

The Hyperfoil 1000-XTC is the latest generation of an unusual hybrid speeder design, mixing standard repulsorlift technology with much less common hovercraft engines. The hover engines give the vehicle a surprisingly high ceiling (50 meters) for such a cheap speeder, and allow for quiet lift and hover options. The design, often referred to as a VTOL (Vertical Take Off and Landing) speeder, for some reason never caught on with other speeder manufacturers.

Because of extra space required by the VTOL technology, Hyperfoils tend to be larger and longer than normal vehicles of the same carrying capacity. Though the vehicle is reliable and easily maintained, the need to cram hover engines into the speeder makes it too big for most urban settings, where its lifting ability would be most useful.

#### Transt A-A5 Speeder Truck

**Class:** Speeder [Ground] **Crew:** 1 (Normal +2)  
**Size:** Colossal **Initiative:** -6 (-8 size, +2 crew)  
 (21.4 m long)  
**Passengers:** 25 **Maneuver:** -6 (-8 size, +2 crew)  
**Cargo Capacity:** 25,000 kg **Defense:** 10\* (-8 size, +8 armor)  
**Cost:** 30,500 (new), **Shield Points:** 0  
 8,250 (used) **Hull Points:** 50 (DR 10)  
**Availability:** Prevalent, **Speed:** 70 m  
 licensed  
**Era:**   **Max Velocity:** 160 km/h  
 (3 sq./action)



*\*Provides three-quarters cover to crew and full cover to passengers.*

Speeder trucks are designed for long cargo hauls over rough terrain, mostly on uncivilized and Outer Rim worlds. The A-A5 cab has room for a three-person crew, allowing the truck to continue over more than a day of travel with the crew alternating between driving and resting. The enclosed cargo bay can carry a great amount of

cargo and still have room left for numerous passengers to be strapped into uncomfortable benches running along the top of the bay.

Because it is most often used in fairly rough areas, the A-A5 is armored as heavily as some light military vehicles, and many have been modified to serve as armored personnel carriers. Some have been equipped with weapon mounts and armed with light blasters or grenade launchers, though it's not a good idea for even the most heavily modified A-A5 to face actual military vehicles in combat.



#### Ubrikkian Commuter Gravsled

**Class:** Speeder [Ground] **Crew:** 1 (Normal +2)  
**Size:** Large (3.5 m long) **Initiative:** +1 (-1 size, +2 crew)  
**Passengers:** 1 **Maneuver:** +1 (-1 size, +2 crew)  
**Cargo Capacity:** 250 kg **Defense:** 10\* (-1 size, +1 armor)  
**Cost:** 1,900 (new), **Shield Points:** 0  
 900 (used) **Hull Points:** 10 (DR 10)  
**Availability:** Prevalent, **Speed:** 36 m  
 licensed  
**Era:**   **Max Velocity:** 90 km/h  
 (2 sq./action)

*\*Provides one-quarter cover to pilot and passenger.*

Gravsleds are slower and cheaper versions of speeders. They use a single repulsorlift engine to provide both lift and thrust, resulting in low speeds. They are inexpensive, however, and are often popular as first vehicles for young teens or as short-distance transportation for civilians. The Ubrikkian Commuter Gravsled is a popular model on many densely populated worlds, perhaps because its side-by-side seats and open cockpit are slightly more stylish than most gravsleds—and it is very cheap.

#### Ubrikkian Personnel Skiff Model VI

**Class:** Speeder [Ground] **Crew:** 1 (Normal +2)  
**Size:** Gargantuan **Initiative:** -2 (-4 size, +2 crew)  
 (17.5 m long)  
**Passengers:** 45 **Maneuver:** -2 (-4 size, +2 crew)  
**Cargo Capacity:** 500 kg **Defense:** 10\* (-4 size, +4 armor)  
**Cost:** 23,000 (new), **Shield Points:** 0  
 12,500 (used) **Hull Points:** 50 (DR 5)  
**Availability:** Prevalent, **Speed:** 40 m  
 licensed  
**Era:**   **Max Velocity:** 100 km/h  
 (2 sq./action)

*\*Provides one-quarter cover to pilot and passengers.*

Personnel skiffs are big, slow, open-air transports designed to move a large number of people. They are sometimes used as cheap hover-buses, but most often serve as transports to get company or military personnel from one area in a base or building to another. The Ubrikkian model is a particularly sturdy vessel; many continue to function well centuries after their construction, ending up as modified cargo skiffs or police and/or pirate paramilitary vehicles on fringe worlds.

#### zZip Motor Concepts Astral-8

**Class:** Speeder [Ground] **Crew:** 1 (Normal +2)  
**Size:** Huge (12 m long) **Initiative:** +0 (-2 size, +2 crew)  
**Passengers:** 8 **Maneuver:** +0 (-2 size, +2 crew)  
**Cargo Capacity:** 250 kg **Defense:** 15\* (-2 size, +7 armor)

**Cost:** 25,000 (new)  
18,000 (used)  
**Availability:** Prevalent,  
licensed  
**Era:**     
**Shield Points:** 0  
**Hull Points:** 30 (DR 10)  
**Speed:** 100 m  
**Max Velocity:** 245 km/h  
(4 sq./action)

*\*Provides three-quarters cover to pilot and full cover to passengers.*

The Astral-8 is a landspeeder for the very wealthy and their entourages. It is designed for comfort, with a single-seat cockpit for the pilot mounted at the front and a much larger passenger section taking up the center of the vehicle. Though a window joins the two compartments, a privacy panel can cut off the view of the passengers from the pilot. The back area comes equipped with a small cold storage unit and drink dispenser, and many owners add some form of entertainment system.

The Astral-8 has a built-in anticoncussion shielding system, making it more resilient than most luxury speeders (statistics for this system are already included in its armor and DR entries). As a result, the Astral-8 is a popular in-town conveyance for many criminals and crime lords (though not generally Hutts, since a single Hutt takes up nearly the entire passenger space).

## Military Groundspeeders

Military speeders operate in the same manner as civilian speeders, but they are designed from the ground up to serve combat functions. Possession of a military speeder is regulated on most worlds, and actually driving one around on public roadways is usually a criminal offense. On less civilized worlds, battered, outdated military speeders are a much more common sight, and may elicit very little official notice.

### Baktoid Armor Workshop Transpeeder

**Class:** Speeder [Ground] **Crew:** 1 (Normal +2)  
**Size:** Medium-size **Initiative:** +2 (+2 crew)  
(2 m long)  
**Passengers:** 0 **Maneuver:** +2 (+2 crew)  
**Cargo Capacity:** 5 kg **Defense:** 13\* (+3 armor)  
**Cost:** 10,000 (new), **Shield Points:** 0  
7,000 (used) **Hull Points:** 20 (DR 5)  
**Availability:** Common, **Speed:** 110 m  
military  
**Era:**  **Max Velocity:** 270 km/h  
(5 sq./action)

*\*Provides no cover to pilot.*

**Weapon:** Double light laser cannon (fire-linked); **Fire Arc:** Front; **Attack Bonus:** +4 (+2 crew, +2 fire control); **Damage:** 4d8; **Range Increment:** 20 m.

The Transpeeder was an effort to design a cheap, small vehicle to increase the effectiveness of an individual soldier in combat. It is a simple design, with a chair mounted above a small repulsorlift engine that provides both lift and thrust. Two small lasers are mounted forward, though some variants replace one laser with a frag grenade launcher.

The Transpeeder was introduced late in the Old Republic and never gained widespread popularity with Republic military leaders. On the battlefield most were eventually superseded by the STAP (see Chapter 11 of the *Star Wars Roleplaying Game*). Most of the vehicles were

sold to planetary security forces, bounty hunters, and big game hunters.

### KAAC Freerunner

**Class:** Speeder [Ground] **Crew:** 5 (Skilled +4)  
**Size:** Gargantuan **Initiative:** +0 (-4 size, +4 crew)  
(14.6 m long)  
**Passengers:** 6 **Maneuver:** +0 (-4 size, +4 crew)  
**Cargo Capacity:** 250 kg **Defense:** 14\* (-4 size, +8 armor)  
**Cost:** 140,000 (new), **Shield Points:** 0  
110,000 (used) **Hull Points:** 80 (DR 10)  
**Availability:** Rare, **Speed:** 120 m  
military  
**Era:**  **Max Velocity:** 300 km/h  
(5 sq./action)

*\*Provides one-half cover to crew and passengers.*

**Weapon:** Double antivehicle laser cannon (fire-linked); **Fire Arc:** Turret; **Attack Bonus:** +2 (-4 size, +4 crew, +2 fire control\*\*); **Damage:** 5d10; **Range Increment:** 200 m.  
**Weapon:** Anti-infantry blasters (2); **Fire Arc:** Partial turret (1 front, left, right; 1 left, right, rear); **Attack Bonus:** +4 (-4 size, +4 crew, +4 fire control\*\*); **Damage:** 4d10; **Range Increment:** 150 m.

*\*\*Fire control only applies if a gunner is firing the weapon. The pilot or copilot may fire the weapon, but receive no fire control bonus on their attacks.*

The Freerunner is a combat assault speeder designed by the Kelliak Arms and Armor Company to be a flexible, powerful vehicle easily modified for any combat situation. The term "freerunner" refers to the independent weapons platform mount along the top of the speeder. Designed with its own power supply and crew positions, the weapons platform can easily accommodate any number of weapons, from heavy cannons to grenade launchers and light repeating blaster cannons (the weapons given in the statistics block represent a fairly typical mix).

Unfortunately, the Freerunner was designed in the very early days of the Empire, and it didn't dovetail with the Imperial tendency to depend on walkers over speeders. As a result, the Freerunner was never put into extended production, and KAAC went out of business. The entire initial run of Freerunners was sold at auction to various weapons dealers, planetary security forces, and even criminals and pirates.

The original Freerunner design had an open cockpit, which gave its pilots a wide field of vision but also made them vulnerable targets. Because it is designed as an assault vehicle rather than a scout, many owners of Freerunners enclose the cockpit (which counts as a modification for the vehicle and provides full cover for the pilot and copilot).

### Mekuun CMD-1 Speeder Command Vehicle

**Class:** Speeder [Ground] **Crew:** 1 (Skilled +4)  
**Size:** Huge (6.2 m long) **Initiative:** -2 (-2 size, +4 crew)  
**Passengers:** 6 **Maneuver:** -2 (-2 size, +4 crew)  
**Cargo Capacity:** 100 kg **Defense:** 16\* (-2 size, +8 armor)  
**Cost:** 40,000 (new), **Shield Points:** 0  
20,400 (used) **Hull Points:** 28 (DR 5)  
**Availability:** Common, **Speed:** 220 m  
military  
**Era:**  **Max Velocity:** 540 km/h  
(9 sq./action)

*\* Provides one-quarter cover to pilot and passengers.*

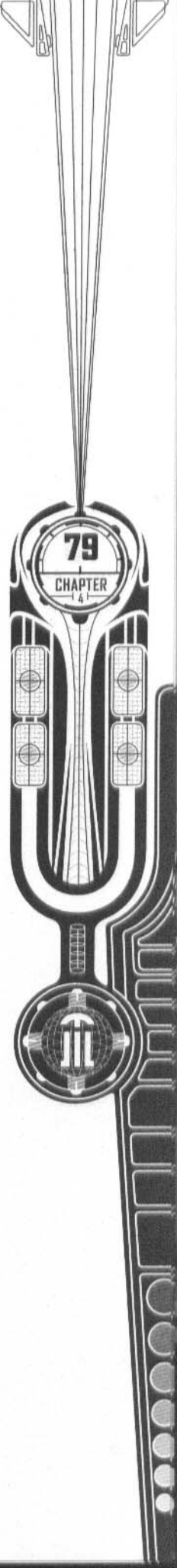

The CMD-1 is a fast, mid-sized speeder designed to allow troop commanders to move around on the battlefield to observe the fighting. It is an open-air vehicle with a single pilot in a swooplike control seat at the front of the craft and a round passenger compartment with seating for six at the rear. The CMD is a fast speeder and fairly well armored, though its open compartments, designed for high visibility, make it unsuitable for direct combat. It is equipped with a long-range com unit, the equivalent of an OmniNode communications set (see Communication Devices in Chapter 5), with a range of 500 kilometers.

The CMD was a common troop observation platform during the latter years of the Old Republic, but it was never very popular with officers. When the Empire came into power, production was halted, but many CMDs remain in service in small military and paramilitary groups throughout the galaxy. Though it was manufactured as an unarmed vehicle, many owners added an E-Web repeating blaster mount to the position directly behind the pilot.

#### Merr-Sonn WW-676 Repulsorlift Sled

**Class:** Speeder [Ground] **Crew:** 2 (Skilled +4)  
**Size:** Large (3.2 m long) **Initiative:** +3 (-1 size, +4 crew)  
**Passengers:** 0 **Maneuver:** +3 (-1 size, +4 crew)  
**Cargo Capacity:** 250 kg **Defense:** 12\* (-1 size, +3 armor)  
**Cost:** 10,000 (new), 7,000 (used) **Shield Points:** 0  
**Hull Points:** 20 (DR 5)  
**Availability:** Common, military **Speed:** 120 m  
**Era:** **Max Velocity:** 300 km/h (5 sq./action)

*\*Provides no cover to crew.*

**Weapon:** Frag grenade launcher (512 grenades); **Fire Arc:** Front; **Attack Bonus:** +7 (-1 size, +4 crew, +4 fire control\*\*); **Damage:** 4d6; **Range Increment:** 100 m (4 m).

*\*\*The grenade launcher cannot act as a multifire weapon if the fire control bonus is used.*

The WW-676 Repulsorlift Sled is a light assault or infantry support vehicle that has been used by many military groups since its introduction during the Old Republic, including several planetary defense groups, the Empire, the Rebellion, and the New Republic. It is essentially a two-person repulsorlift platform for a MobileMortar-3 grenade launcher (see Grenade Launchers in Chapter 1) with a huge magazine.

When braced by the weight of its sled, a MobileMortar-3 can lay down a withering barrage of firepower much greater than its normal output (the weapon gains the ability to multifire). Although it has a fire control system, the view-screen and controls are awkward and slow the rate of fire, encouraging experienced gunners to ignore the system. The pilot sits atop the repulsorlift unit in a position above and behind the gunner. A variant of the WW-676 replaces the grenade launcher with an E-Web repeating blaster and its power pack.

WW-676s are generally assigned to army units as infantry support, though they are occasionally combined with speeder bikes for armed patrols, and groups of four are sometimes deployed as mechanized infantry.

#### Siemar Ultra-Light Assault Vehicle

**Class:** Speeder [Ground] **Crew:** 2 (Normal +2)  
**Size:** Large (7 m long) **Initiative:** +1 (-1 size, +2 crew)  
**Passengers:** 0 **Maneuver:** +1 (-1 size, +2 crew)  
**Cargo Capacity:** 5 kg **Defense:** 14\* (-1 size, +5 armor)  
**Cost:** 20,000 (new), 13,000 (used) **Shield Points:** 0  
**Hull Points:** 60 (DR 5)  
**Availability:** Common, military **Speed:** 160 m  
**Era:** **Max Velocity:** 400 km/h (7 sq./action)

*\*Provides three-quarters cover to crew.*

**Weapon:** Double light blaster cannon (fire-linked); **Fire Arc:** Front; **Attack Bonus:** +3 (-1 size, +2 crew, +2 fire control); **Damage:** 2d10; **Range Increment:** 200 m.

**Weapon:** Concussive grenade launcher (6 grenades); **Fire Arc:** Front; **Attack Bonus:** +3 (-1 size, +2 crew, +2 fire control); **Damage:** 4d6+1 **Range Increment:** 20 m (4 m).  
**Weapon:** Medium blaster cannon; **Fire Arc:** Left, right, rear; **Attack Bonus:** +5 (-1 size, +2 crew, +4 fire control); **Damage:** 4d10; **Range Increment:** 500 m.

The Siemar ULAV was popular in the waning days of the Old Republic and the early years of the Empire, before it was replaced in the Imperial arsenal with walkers. The ULAV is a small, fully enclosed speeder with a few light weapons facing forward and a powerful blaster cannon to the rear. It is lightly armored for a military vehicle, but is surprisingly fast and well armed. Designed to be operated by a single pilot and a gunner, the ULAV uses much the same tactics as a starfighter, weaving quickly in and out among more powerful military vehicles, making quick hit-and-run strikes.

ULAVs fell out of service with the Empire when more powerful walker designs became popular. ULAVs lacked the utility to be attractive to police forces or the cargo capacity to attract criminals and pirates. Most were mothballed in warehouses and forgotten until the Rebel Alliance found them. Though second-rate military hardware, they were a major find for the Rebellion, which often modified them for harsher climates than their original designs could handle.

#### SoroSuub V-19 Gian Speeder

**Class:** Speeder [Ground] **Crew:** 2 (Normal +2)  
**Size:** Large (5.7 m long) **Initiative:** +1 (-1 size, +2 crew)  
**Passengers:** 2 **Maneuver:** +1 (-1 size, +2 crew)  
**Cargo Capacity:** 50 kg **Defense:** 13\* (-1 size, +4 armor)  
**Cost:** 20,000 (new), 10,000 (used) **Shield Points:** 0  
**Hull Points:** 27 (DR 10)  
**Availability:** Prevalent, licensed **Speed:** 100 m  
**Era:** **Max Velocity:** 240 km/h (4 sq./action)

*\*Provides one-half cover to crew.*

**Weapon:** Double repeating blaster cannon (fire-linked); **Fire Arc:** Front; **Attack Bonus:** +3 (-1 size, +2 crew, +2 fire control); **Damage:** 4d8; **Range Increment:** 30 m.

**Weapon:** Repeating blaster cannon; **Fire Arc:** Turret; **Attack Bonus:** +3 (-1 size, +2 crew, +2 fire control); **Damage:** 4d8; **Range Increment:** 30 m.

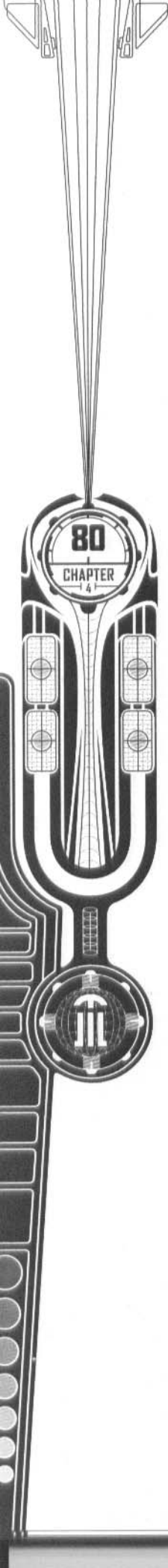



The V-19 Gian is a heavier, slower version of the flash speeder (see Chapter Ten of the *Star Wars Roleplaying Game*) designed to be used in riot control or as a military transport for officers. It has an open-air crew compartment that allows for high visibility, and three heavy repeating blasters. Normally the two passengers are observers or specialists, but some Gians were modified to make them additional gunners. Since speed was less important than durability in the Gian, the turbine thrusters were made smaller and kept close to the body, making them easier to armor.

## Walkers

Though the earliest walker designs were hundreds of years old at the time, huge advances in walker vehicles were made toward the end of the Old Republic and in the early days of the Empire. Hovermines that sought out repulsorlift vehicles, coupled with durasteel barriers that impeded wheeled vehicles, made walkers not only practical but almost a necessity. The Empire soon found that large walkers such as the AT-AT also had use as weapons of terror, their massive size serving as a deterrent to any civilian population that found itself watched by the long-legged weapon platforms.

Walkers retain their balance through finely tuned gyroscopes, and actually offer a fairly smooth ride. They rely on even footing, however, and when they topple, the results can be disastrous.

### Arakyd Emperix Walking Throne

**Class:** Walker [Ground] **Crew:** 1 (Normal +2)  
**Size:** Large **Initiative:** +1 (-1 size, +2 crew)  
 (4 m long, 4 m tall)  
**Passengers:** 0 **Maneuver:** +1 (-1 size, +2 crew)  
**Cargo Capacity:** 300 kg **Defense:** 11\* (-1 size, +2 armor)  
**Cost:** 40,000 (new), **Shield Points:** 0  
 24,000 (used) **Hull Points:** 40 (DR 10)  
**Availability:** Common **Speed:** 12 m  
**Era:**  **Max Velocity:** 30 km/h  
 (1 sq./2 actions)

*\*Provides no cover to pilot.*

**Weapon:** Walker limb; **Fire Arc:** Turret; **Attack Bonus:** +7 (-1 size, +2 crew, +6 fire control); **Damage:** 2d6+6; **Reach:** 4 m.

The Emperix may be the first walker ever put into mass production. Originally a custom design for a petty warlord during the last centuries of the Old Republic, the Emperix received so many requests for special orders in the following years that Arakyd made it part of the company's standard line. Production continued until the rise of the Empire, when lucrative military walker contracts made Emperix production less attractive to the company.

The Emperix is little more than an ornate seat atop a big storage bay, with six long, arachnidlike legs propelling it. The throne is extremely simple to control, and can be guided with foot pedals hidden at the base of the throne, allowing the pilot to look like nothing more than a passenger. Though it does not mount a ranged weapon, the walker is stable enough that it can use any one leg at a time as a melee weapon.

A modified version, the Royux, removes 150 kg of cargo capacity to mount a pilot chamber within the lower housing.

This version provides three-quarters cover to its pilot, but no cover to its passenger (who sits in the throne).

### Caridan Test Grounds MT-AT

**Class:** Walker [Ground] **Crew:** 3 (Skilled +4)  
**Size:** Gargantuan **Initiative:** +0 (-4 size, +4 crew)  
 (15.6 m long, 12 m wide, 12 m tall)  
**Passengers:** 0 **Maneuver:** +0 (-4 size, +4 crew)  
**Cargo Capacity:** 300 kg **Defense:** 12\* (-4 size, +6 armor)  
**Cost:** 80,000 (new), **Shield Points:** 0  
 48,000 (used) **Hull Points:** 70 (DR 15)  
**Availability:** Common, **Speed:** 36 m  
 restricted  
**Era:**  **Max Velocity:** 90 km/h  
 (2 sq./action)

*\*Provides full cover to pilot and crew.*

**Weapon:** Double blaster cannon (fire-linked); **Fire Arc:** Front; **Attack Bonus:** +6 (-2 size, +4 crew, +4 fire control); **Damage:** 4d10; **Range Increment:** 200 m.  
**Weapon:** Rotating blaster cannons (8); **Fire Arc:** Turret; **Attack Bonus:** +2 (-2 size, +2 crew, +2 fire control); **Damage:** 1d10; **Range Increment:** 100 m.

One of the last walkers to be designed during the time of the Empire was the Mountain Terrain Armored Transport. Representing the first in a new line of terrain-specific armor units under consideration by the Empire, the MT-AT saw limited use before the Caridan Test Grounds were destroyed, but the plans were saved, and other MT-AT manufacturing plants might have been built since.

Also known as the Spider Walker, the MT-AT has a central drive pod with eight motorized legs, a forward cockpit on a flexible joint, and a rear cargo pod that is kept elevated during movement but can be lowered to the ground for easy unloading by troops. Each of the spiderlike legs is armed with a rotating light blaster, and a more powerful set of blasters is mounted under the cockpit. Some MT-ATs traded 400 kg of cargo space for the ability to carry four troopers as passengers.

### Kuat Drive Yards AT-PT

**Class:** Walker [Ground] **Crew:** 1 (Skilled +4)  
**Size:** Large (4 m long, **Initiative:** +3 (-1 size, +4 crew)  
 3 m tall)  
**Passengers:** 0 **Maneuver:** +3 (-1 size, +4 crew)  
**Cargo Capacity:** 150 kg **Defense:** 13\* (-1 size, +4 armor)  
**Cost:** 60,000 (new), **Shield Points:** 0  
 36,000 (used) **Hull Points:** 50 (DR 10)  
**Availability:** Common, **Speed:** 25 m  
 military  
**Era:**  **Max Velocity:** 60 km/h  
 (1 sq./action)

*\*Provides full cover to pilot.*

**Weapon:** Double heavy blaster cannon (fire-linked); **Fire Arc:** Front; **Attack Bonus:** +5 (-1 size, +4 crew, +2 fire control); **Damage:** 5d10; **Range Increment:** 200 m.  
**Weapon:** Concussion grenade launcher (8 grenades); **Fire Arc:** Front; **Attack Bonus:** +5 (-1 size, +4 crew, +2 fire control); **Damage:** 4d6+1; **Range Increment:** 20 m (6 m).

One of the earliest mass-produced lines of walkers was the Old Republic's All Terrain Personal Transport. This one-person fighting machine was designed to turn a single

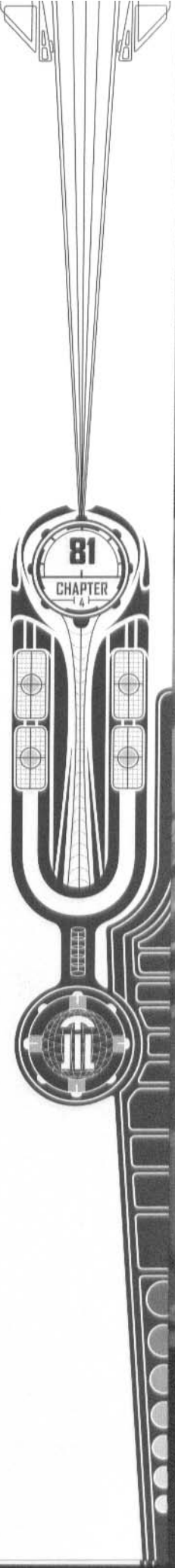

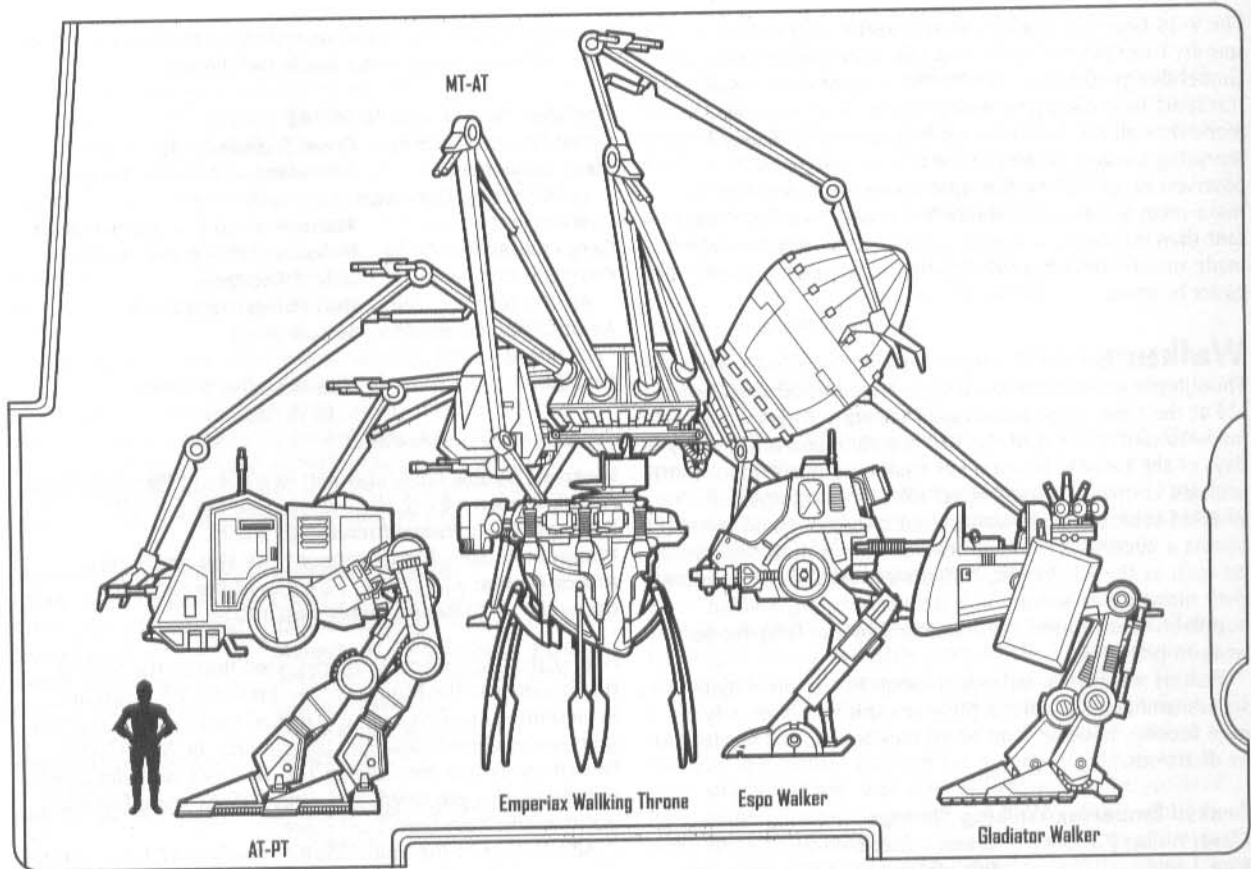

soldier into an unstoppable assault trooper, giving him all the firepower of an assault vehicle while retaining the mobility and versatility of infantry. The AT-PT consists of an armored cockpit with one leg mounted to either side, with enough room for a pilot and (in a pinch) a single passenger. The AT-PT is capable of standing upright to a height of 4 meters, but normally moves in a crouch that makes it about 3 meters tall.

Armed with twin blaster cannons and a concussion grenade launcher, the AT-PT might well have changed the face of warfare, but most of the initial production run was lost when the fleet carrying the walkers was lost after a hyperspace mishap. The Old Republic dissolved before a modified AT-PT could be produced, and the Empire scrapped the project in favor of the larger AT-ST. Those few AT-PTs that still exist are generally kept in working condition, however, and can prove a nasty surprise to anyone who hasn't faced one before.

#### SecuriTech Espo Walker

**Class:** Walker [Ground]

**Size:** Huge (4 m long, 5 m tall)

**Passengers:** 0

**Cargo Capacity:** 40 kg

**Cost:** 40,000 (new), 24,000 (used)

**Availability:** Common, restricted

**Era:**

**Crew:** 1 (Normal +2)

**Initiative:** +0 (-2 size, +2 crew)

**Maneuver:** +0 (-2 size, +2 crew)

**Defense:** 17\* (-2 size, +9 armor)

**Shield Points:** 0

**Hull Points:** 40 (DR 5)

**Speed:** 25 m

**Max Velocity:** 60 km/h (1 sq./action)

\*Provides one-quarter cover to pilot.

**Weapon:** Light blaster cannon; **Fire Arc:** Front; **Attack Bonus:** +2 (-2 size, +2 crew, +2 fire control); **Damage:** 4d10; **Range Increment:** 50 m.

**Weapon:** Heavy stun cannon; **Fire Arc:** Front; **Attack Bonus:** +2 (-2 size, +2 crew, +2 fire control); **Damage:** Stun (DC 23); **Range Increment:** 40 m.

**Weapon:** Concussion grenade launcher (8 grenades); **Fire Arc:** Front; **Attack Bonus:** +2 (-2 size, +2 crew, +2 fire control); **Damage:** 4d6+1; **Range Increment:** 20 m (6 m).

After the Empire proved that walkers could be effective in military situations, the Corporate Sector decided to develop a walker for use by its security forces. These were inspired by the old AT-PT idea of a one-person walker, but actually followed the upright carriage of the AT-ST more closely. This design allows the Espo walker to carry heavier armor, though its internal components are actually less rugged. To increase visibility and decrease production costs, the cockpit of the Espo walker is far more open than that of most military vehicles, with a thin duraplast screen offering little protection.

Since security forces are more likely to break up mobs than assault bunkers, the Espo walker has a light weapons mix, the most notable component of which is the stun cannon—maybe the largest and most powerful stun-only weapon ever built. However, it would be a mistake to overlook the light blaster and concussion grenade launcher, which give the Espo walker enough firepower to deal with even the most well-equipped criminals. Though Espo walkers are built specifically for the Corporate Sector, some inevitably find their way into the hands of criminals and pirates, and some used models are sometimes sold to private security forces.

**zZip Motor Concepts Gladiator Walker**  
**Class:** Walker [Ground] **Crew:** 1 (Skilled+4)  
**Size:** Large (2 m long, 3 m tall) **Initiative:** +3 (-1 size, +4 crew)  
**Passengers:** 0 **Maneuver:** +3 (-1 size, +4 crew)  
**Cargo Capacity:** 40 kg **Defense:** 14\* (-1 size, +5 armor)  
**Cost:** 40,000 (new), 24,000 (used) **Shield Points:** 0  
**Availability:** Common, restricted **Hull Points:** 50 (DR 10)  
**Era:** ☉ **Speed:** 25 m  
**Max Velocity:** 60 km/h (1 sq./action)

\*Provides three-quarters cover to pilot.

**Weapon:** Light blaster cannon; **Fire Arc:** Front; **Attack Bonus:** +1 (-1 size, +2 crew); **Damage:** 2d10; **Range Increment:** 100 m.

Some of the earliest walker designs were not intended for combat, but for complex gladiatorial games. These games mostly lost popularity with the rise of Podracing during the latter years of the Old Republic, but the practice never entirely disappeared. A typical gladiator walker, such as this model, stands 3 meters tall and carries a single blaster rifle that the pilot aims by eye from an open-air cockpit.

During the height of the Empire, droid gladiators became very common, and this popularity led to a small resurgence of gladiatorial walkers for sport enthusiasts wishing to face the hulking droids in carefully monitored combat. In less civilized areas, these civilian walkers are sometimes used for police patrols or even criminal activities.

## Seacraft

Though most speeders are capable of traveling over water, very few are designed to do so. A strong wave could knock a speeder over—a catastrophe for groundspeeders, which rarely float. Aquatic speeders follow all the rules for groundspeeders (including being able to travel over land), but are sealed against fluids and self-righting if tipped in a storm. Aquatic speeders do not function underwater.

### Sadrimators Amphibion

**Class:** Speeder (Aquatic) **Crew:** 2 (Skilled +4)  
**Size:** Huge (7.3 m long) **Initiative:** +2 (-2 size, +4 crew)  
**Passengers:** 20 **Maneuver:** +2 (-2 size, +4 crew)  
**Cargo Capacity:** 200 kg **Defense:** 14\* (-2 size, +6 armor)  
**Cost:** 25,000 (new), 16,000 (used) **Shield Points:** 0  
**Availability:** Specialized, licensed **Hull Points:** 50 (DR 10)  
**Era:** ☉ **Speed:** 40 m  
**Max Velocity:** 100 km/h (2 sq./action)

\*Provides three-quarters cover to crew and passengers.

**Weapon:** Antipersonnel laser; **Fire Arc:** Turret; **Attack Bonus:** +4 (-2 size, +4 crew, +2 fire control); **Damage:** 3d10; **Range Increment:** 50 m.

The Amphibion is a troop transport and combat support vehicle. The first models were designed during the Old Republic, but the project didn't move into production until the New Republic decided it needed a cheap, mass-produced vehicle to protect and patrol such worlds as Mon Calamari. The Amphibion is designed for use almost exclusively at sea, though it can travel over flat ground surfaces. Though classified as a speeder, the vehicle actually uses much older hover

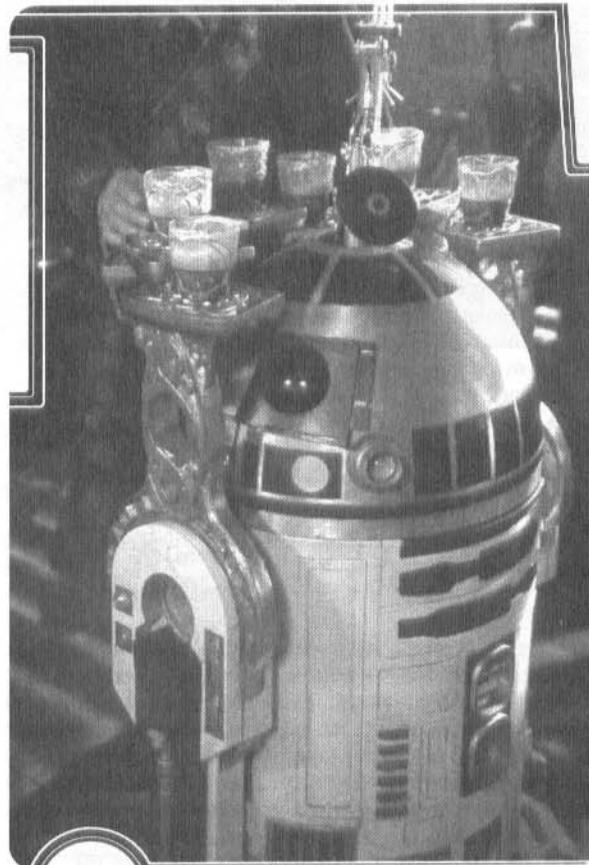

technology, with a series of turbothrust engines creating a cushion of air atop which the Amphibion rides.

The pilot and gunner sit in an enclosed cockpit at the top and front of the vessel. The speeder flares quickly from its nose into a wide, curved shape that allows it to carry up to twenty troopers and their gear. The back of the Amphibion is more square, and houses the antipersonnel laser turret and main power generator. A skirt of armor plating rings the Amphibion, serving both to protect it and to capture the cushion of air on which it travels.

## Other Vehicles

Some vehicles are not easily categorized. A few odd and unusual—but useful—varieties are covered in this section.

### Aratach A14 Repulsorlift Disk

**Class:** Airspeeder **Crew:** 1 (Normal +2)  
**Size:** Medium-size **Initiative:** +2 (+2 crew)  
 (1 m diam.)  
**Passengers:** 0 **Maneuver:** +2 (+2 crew)  
**Cargo Capacity:** 2 kg **Defense:** 10\* (+0 armor)  
**Cost:** 1,000 (new), 400 (used) **Shield Points:** 0  
**Availability:** Prevalent **Hull Points:** 10 (DR 5)  
**Era:** ☉ ☪ ☫ **Atmospheric Speed:** 2 sq./action  
**Altitude:** Atmospheric

\*Provides one-quarter cover to pilot against attacks from below only.

A repulsorlift disk is not so much a vehicle as a tool. With a low speed, no room for cargo or passengers, and few safety features, a repulsorlift disk is not designed to carry its operator over long distances. Its main purpose is to allow workers

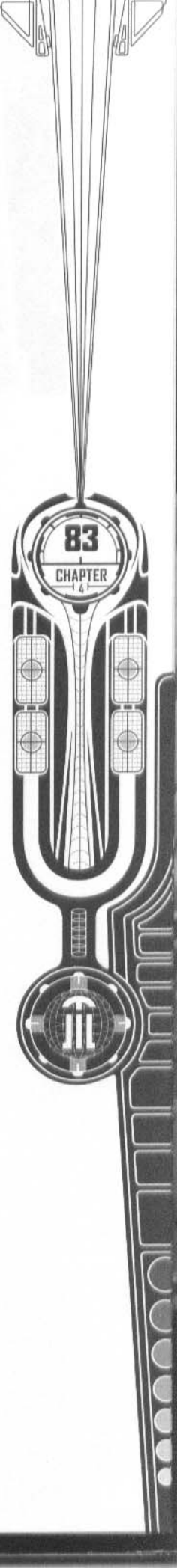

to gain easy access to out-of-the-way locales, mostly in shipyards and large warehouses. On a few very civilized worlds, such disks are also used to allow peacekeepers to access and patrol the upper reaches of a city's towering buildings, but this usage is much less common.

The A14 is a simple disk with foot straps, under which a small repulsorlift generator and air jets are mounted. A safety ring and control panel are mounted 1 1/2 meters above the disk, and encircle the disk's operator.

#### CMC Mining Digger ("Sandcrawler")

**Class:** Wheeled [Ground] **Crew:** 46 (Normal +2)  
**Size:** Colossal **Initiative:** -6 (-8 size, +2 crew)  
(36.8 m long, 20 m tall)  
**Passengers:** 30 **Maneuver:** -6 (-8 size, +2 crew)  
**Cargo Capacity:** 50,000 kg **Defense:** 12\* (-8 size, +10 armor)  
**Cost:** 150,000 (new), **Shield Points:** 0  
60,000 (used) **Hull Points:** 160 (DR 5)  
**Availability:** Specialized **Speed:** 12 m  
**Era:** ☉ **Max Velocity:** 30 km/h  
(1 sq./2 actions)

*\*Provides full cover to crew and passengers.*

The Corellia Mining Corporation built thousands of these huge mobile refineries in the early days of hyperspace travel, and hundreds remain functional on planets throughout the galaxy. Each crawler stands a gigantic 20 meters tall and twice that long. It is driven by eight massive treads run by engines that are actually high-tech steam turbines (with closed water reclamation valves, so moisture is never lost), designed to use almost any burnable material as fuel. The topmost level contains the control bridge, crew quarters, navigation array and sensors, while lower levels have cavernous storage bays and internal smelting facilities. If cargo space is converted to hold additional personnel, the number of possible passengers can rise dramatically.

The Mining Digger is built to withstand nearly any environment, from extreme cold to unbearable heat, and is sealed against storms, lightning, and clouds of dust or sand. The prow of each crawler can fold down to create a huge ramp, or entry can be gained via a side gantry, several access hatches, or the repulsorlift cargo tube. The crawler was designed with ease of maintenance in mind; most components are easily accessible, and many are interchangeable. On many worlds, crawlers abandoned by mining companies (they are too expensive to scrap or ship) remain usable for centuries after all mining has been depleted. They tend to be too slow and too vulnerable to blaster fire to be converted to military use.

#### Kuat Drive Yards A5 Juggernaut HAV

**Class:** Wheeled [Ground] **Crew:** 7 (Skilled +4)  
**Size:** Colossal **Initiative:** -4 (-8 size, +4 crew)  
(22 m long, 15 m tall)  
**Passengers:** 50 **Maneuver:** -4 (-8 size, +4 crew)  
**Cargo Capacity:** 1,000 kg **Defense:** 12\* (-8 size, +10 armor)  
**Cost:** 200,000 (new), **Shield Points:** 0  
120,000 (used) **Hull Points:** 160 (DR 20)  
**Availability:** Common, **Speed:** 80 m  
military  
**Era:** ☉ **Max Velocity:** 200 km/h  
(3 sq./action)

*\*Provides full cover to crew and passengers.*

**Weapon:** Heavy laser cannons (3); **Fire Arc:** Turret; **Attack Bonus:** +0 (-8 size, +4 crew, +4 fire control\*\*); **Damage:** 5d10; **Range Increment:** 200 m.

**Weapon:** Double medium blaster (fire-linked); **Fire Arc:** Turret; **Attack Bonus:** +0 (-8 size, +4 crew, +4 fire control\*\*); **Damage:** 4d10; **Range Increment:** 150 m.

**Weapon:** Concussion grenade launchers (2, 10 grenades each); **Fire Arc:** Turret; **Attack Bonus:** +0 (-8 size, +4 crew, +4 fire control\*\*); **Damage:** 4d6+1; **Range Increment:** 40 m (6 m).

*\*\*If there is no sentry in the observation tower, drop all fire control bonuses by -2.*

The A5 is the last model in Kuat Drive Yards' ancient line of Juggernaut Heavy Assault Vehicles. Designed during the days of the Old Republic, for decades the A5 was popular with planetary defense forces and large corporations as the ultimate ground unit. When the Empire turned to the AT-AT walker (see Chapter 10 of the *Star Wars Roleplaying Game*) to fulfill this role, many Juggernauts became military surplus. Though some were snatched up by the Imperial Army (for use at installations that didn't qualify for AT-ATs), many more were snatched up by crime lords and petty planetary warlords.

The Juggernaut depends on five massive sets of wheels for motive power, allowing it to carry far more armor than comparable speeders. Though the A5's top speed is an impressive 200 km/h, the Juggernaut cannot perform any turns if moving faster than 24 km/h (a speed of 10 m). Luckily, it has a command post at each end, allowing it to reverse direction without any loss of control. The Juggernaut was designed to hold fifty troops in powered armor, six speeder bikes, or two light groundspeeders.

In addition to three heavy blasters, each mounted in its own turret, and two fire-linked medium blasters in a turret, the A5 has two small grenade launchers in turrets (for assisting ground troops) and a manned, armored sentry tower. While most of the Juggernaut is no more than 10 meters high, the sentry tower reaches 5 meters above that, allowing the crew member in the tower to assist the gunners in targeting.



For every imaginable task, there is a tool designed specifically to assist in performing it. Of course there is a limit to how much one person can carry or one vehicle can store, so most people only carry the equipment they expect to use on a regular basis. And carrying too much gear has its price: Sometimes having an extra scanner and fusion cutter means you can slip past an opponent's security—and sometimes it means you sink to the bottom of a lake. Choosing the right gear for the mission is always a balancing act.

Each equipment writeup in this chapter includes the item's cost, era, availability, and weight, as follows.

**Cost:** The normal cost for a new item, in credits.

**Weight:** The item's weight.

**Availability:** How available the item is. See Equipment Availability in the introduction for definitions of the various availability ratings.

**Era:** The eras of play in which the item is usually available. See the introduction for more information.

A piece of equipment is not normally sold as a used item unless it has been extensively refurbished, in which case it costs 80% of the item's normal cost. An unrefurbished used item generally costs 75% of the item's normal cost, but such items have a 10% chance of failing each time they are used.

Some types of equipment may be mastercrafted by tech specialists, as noted in the entries for those types. While trained tech specialists may increase the performance of an item beyond +1, such highly enhanced items can rarely be found for sale on the open market.

## Breathing Devices

It's a big universe, with lots of places where one can't draw a decent breath of air. Whether you find yourself underwater, on a world with a poisonous atmosphere, or just climbing to a mountaintop, it's a good idea to have at least one breathing device with you. Most of these devices are equipped with an oxygen/nitrogen gas mix that works for many species, but it is possible to find breathing devices geared for other air mixes, usually at the same cost as equivalent items for oxygen-breathers.

### A99 Aquata Breather

**Cost:** 350

**Availability:** Common

**Weight:** 0.2 kg

**Era:** 

The A99 Aquata Breather is a simple one-piece compressed air supply device, popular because of its reliability and compact size. It is placed in the mouth and provides up to 2 hours of fresh air. It folds down for storage and can be easily

concealed in a sleeve or pocket. The Breather's only drawback is that it is designed to be disposable, and once used it cannot be refilled—instead, a whole new Breather must be purchased.

### Gandorthral Atmospheric Oxidizer

**Cost:** 350

**Availability:** Prevalent

**Weight:** 0.25 kg

**Era:** 

The Atmospheric Oxidizer is a simple face mask that covers the nose and mouth, with a small purifying cylinder mounted to the bottom. The oxidizer has a complex scrubber system that allows it to pull breathable gases out of otherwise poisonous atmospheres. Unlike the Roamer-6, its scrubbers don't need to be replaced, and it uses a standard energy cell (which allows 4 hours of operation). The oxidizer

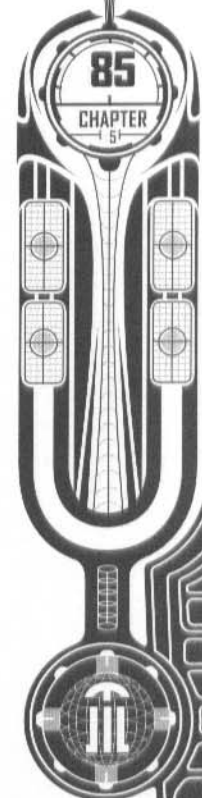
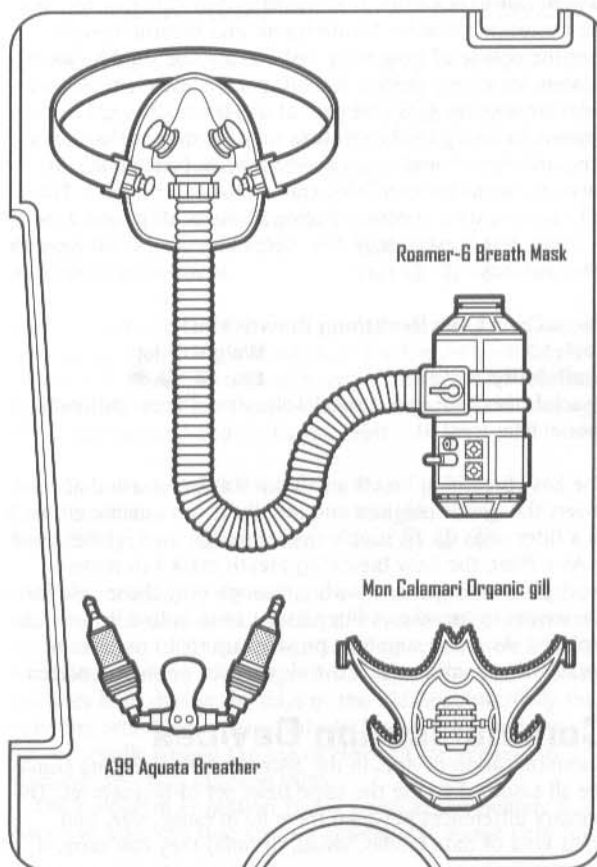

carries no internal air supply, however, and only functions in an atmosphere that contains at least some oxygen.

#### **Gandorthral Atmospheric Roamer-6 Breath Mask**

**Cost:** 400

**Weight:** 0.5 kg

**Availability:** Prevalent

**Era:** 

**Special:** This item uses a special air cylinder (cost 50) and special air scrubbers (cost 100).

The Roamer-6 breath mask is a masterpiece of engineering. It consists of a small face mask (attached by an adjustable strap) connected by a tube to a cylinder containing both a compressed air supply and a series of air scrubbers. A comlink is also built into the mask.

When used in an atmosphere containing poison gases mixed with breathable air, the Roamer-6 pulls in the local air and cleanses the poisons, allowing the wearer to breathe safely. The scrubbers can be set for most races, and last about 6 hours, depending on the severity of the poisons the local air. If there is not enough breathable gas in the atmosphere, the roamer uses its 10-minute compressed air supply. The scrubbers and compressed air cylinders are both small and can be replaced as a move action.

Because it is cheap, versatile and effective, the Roamer-6 is standard issue on many starships.

#### **Mon Calamari Organic Gill**

**Cost:** 200

**Weight:** 0.1 kg

**Availability:** Specialized

**Era:** 

An organic gill is a bioengineered creature that filters oxygen out of seawater. It is used by Mon Calamari to ease the transition between breathing air and breathing water over the course of long trips, but can also be used by most oxygen-breathing species. (Sullustans are allergic to Mon Calamari organic gills and cannot use them.) The gill appears to be a jellylike creature that fits over the wearer's nose and mouth and easily accepts mechanical additions such as clamps for comlinks, chin straps and goggles. The gill can provide a constant stream of air as long as it is kept in water, but it eventually dies, becoming useless one month after purchase.

#### **VargeCorp Easy Breathing Breath Mask**

**Cost:** 50

**Weight:** 1 kg

**Availability:** Prevalent

**Era:** 

**Special:** This item uses a special air cylinder (cost 20) and a special filter (cost 5).

The Easy Breathing breath mask is a full face mask that covers the eyes, ears, nose and mouth. It can operate either as a filter or as an air supply.

As a filter, the Easy Breathing breath mask can remove most poisonous gases, allowing through only those safe for the wearer to breathe. A filter lasts 1 hour before it must be replaced. As an air supply, it provides up to 10 minutes of breathable air, after which the air cylinder must be replaced.

## **Communication Devices**

Communication devices in the *Star Wars Roleplaying Game* are all assumed to use the same basic set of frequencies. The primary differences between them lie in range, size, and what kind of data (audio, visual, or holo) they can carry. If

two or more communication devices are within range of one another and share a data type, they can communicate.

The communication devices here generally carry audio signals only unless otherwise noted. Some external devices can be connected to standard audio comlinks to send different kinds of signals. For example, the BCC OmniNode communications set normally sends and receives audio communications only. The SoroSuub Imagecaster only displays holographic data—it doesn't transmit it. However, by connecting the two, it's possible for the Imagecaster to display holographic data received via the OmniNode communications set.

#### **BCC MultiNode Communications Link**

**Cost:** 75

**Weight:** 0.1 kg

**Availability:** Prevalent

**Era:** 

The MultiNode communications link is a cheap and common form of comlink. It can send and transmit messages over a short range (5 km overland and up to low orbit on clear days with no interference). It can beep or vibrate to signal an incoming message. It is small enough to be mounted on a set of goggles or in a helmet (Repair check DC 10).

#### **BCC OmniNode Communications Set**

**Cost:** 300

**Weight:** 2 kg

**Availability:** Prevalent

**Era:** 

The OmniNode communications set is a larger, more powerful version of the simple MultiNode. It is the size of a small backpack, and it has a normal range of 50 km overland and up to any standard orbit. These ranges can be expanded by connecting the OmniNode to a more powerful energy source, such as a vehicle (Repair check DC 15). This can increase the range to up to 500 km overland and to distant planetary orbits.

#### **Cirenian Communications Model SW-95 Message Transceiver**

**Cost:** 400

**Weight:** 0.5 kg

**Availability:** Common

**Era:** 

The Model SW-95 message transceiver is a specially designed comlink that sends its signal piggybacked on other signals and through relay stations, giving it a greatly expanded range. Under optimal conditions on highly advanced worlds (with lots of other comlink traffic) it has a range of up to 2,000 km overland, and it can reach starships in low orbit. On less advanced worlds with less powerful signals, the SW-95 generally has a range close to 500 km, and on worlds with no other com signals its range drops to a mere 25 km.

#### **Crozo Industrial Products 3-Mal Personal Comlink**

**Cost:** 250

**Weight:** 0.1 kg

**Availability:** Prevalent

**Era:** 

The 3-Mal is a comlink used throughout the galaxy. It is a small handheld cylinder with simple controls. It has a range of 50 km overland and up to low orbit. In addition to transmitting and receiving messages along any of hundreds of channels, the 3-Mal automatically monitors local "standard clear frequencies" (SCFs), which are used for emergency news bulletins by military and civilian authorities.

### Culcanis MicroInstruments Tagger

**Cost:** 450

**Availability:** Rare

**Weight:** 0.1 kg

**Era:** ⚙️ ⚡️ ⚙️

The tagger is unassuming in appearance—a small cylinder of metal about the size and shape of a stylus. In fact, the tagger is a useful tool for tracking individuals without their knowledge. It contains a single air-pressure-fired dart with a range of 4 meters. The dart is extremely small (5 millimeters long) and contains a tiny transmitter with a range of 1.2 km and a life of 40 hours.

The dart is fired from the stylus, and once attached to a target (requiring a ranged touch attack) it broadcasts its location once every 5 minutes. The broadcast is very difficult for normal sensors to locate (Computer Use check DC 30), but informs the specially tuned tagger of the dart's direction and range.

The transmitter may also be loaded into a standard dart thrower (see Special Dart Ammunition in Chapter 1) and tracked in the same fashion.

### Fabritech PAC20 Visual Wrist Com

**Cost:** 1,500

**Availability:** Common

**Weight:** 0.1 kg

**Era:** ⚙️ ⚡️ ⚙️

The PAC20 Visual Wrist Com is a comlink popular with smugglers and soldiers who frequently need to see whom they're dealing with and who want to do so in a hands-free manner. A small, flat rectangle that can be easily attached to a glove (or most any surface), the PAC20 can send and receive visual images as well as standard audio signals, and can even display holoimage data (though only as a two-dimensional image). It has a good range—75 km overland and out to most standard planetary orbits—but requires a new energy cell after 10 days of operation.

The PAC20 is also a very basic datapad, able to store and receive data from droids, com signals, and direct computer links, as well as standard data cards.

### Naboo Technologies Secure-A3 Comlink

**Cost:** 900

**Availability:** Common

**Weight:** 0.05 kg

**Era:** ⚙️ ⚡️ ⚙️

The Secure-A3 is a top-of-the-line comlink designed for military use. Though this particular model is available only on Naboo, similar models are made on most technologically advanced worlds. It has a range of 50 km overland, and can reach low orbit. It can send encrypted messages requiring a computer and a Computer Use check (DC 35) to decrypt them if they are intercepted.

The Secure-A3 comes with a holder that can be clipped to a belt or pocket and holds the comlink securely until it is grasped.

### Plescinea Entertainments CS-Mark 12 Hologram Projector

**Cost:** 10,000

**Availability:** Common

**Weight:** 500 kg

**Era:** ⚡️ ⚙️

The CS-Mark 12 hologram projector is a large console device 4 meters in diameter. It is designed to receive holographic images from data slides, droids, comlinks, subspace and hypertransceivers and even HoloNet transceivers. The CS-Mark 12 has controls to record, transmit, and manipulate holo-

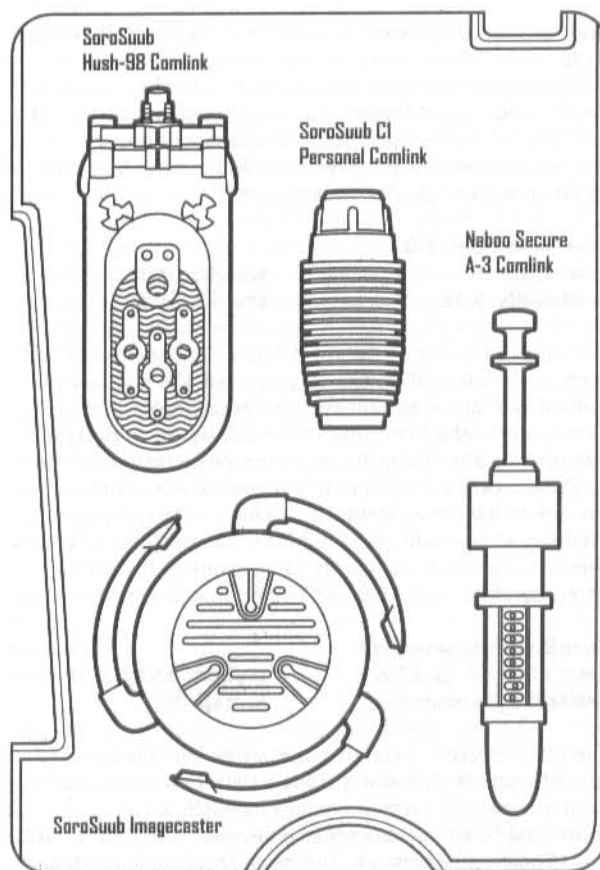

graphic images, and can project a holographic image up to 5 meters in diameter. It is most often used for entertainment purposes among the very wealthy, but it can also prepare and present military information in an easy and accurate format.

The CS-Mark 12 is a receiver only and cannot transmit.

### SoroSuub C1 Personal Comlink

**Cost:** 200

**Availability:** Prevalent

**Weight:** 0.1 kg

**Era:** ⚙️ ⚡️ ⚙️

The C1 is a basic comlink used throughout the galaxy. It was selected as the standard comlink of the Empire's military forces. It is a headset unit, although it can also be mounted inside a helmet. It is an audio-only com system with a range of 50 km overland and up to low orbit.

### SoroSuub Hologram Projection Pod

**Cost:** 250,000

**Availability:** Rare (⚡️ restricted)

**Weight:** 100 kg

**Era:** ⚙️ ⚡️ ⚙️

HoloNet transceivers are rare and expensive systems that allow for real-time audio, visual, and holographic communication over an unlimited range. HoloNet transceivers function by taking advantage of the vast system of HoloNet satellites built during the days of the Old Republic. Only the most important ships carry HoloNet transceivers, and the Empire legally limited the use of HoloNet transceivers to licensed (generally military) ships.

The Hologram Projection Pod is a disk approximately 2 meters in diameter that sends a holographic image (and full

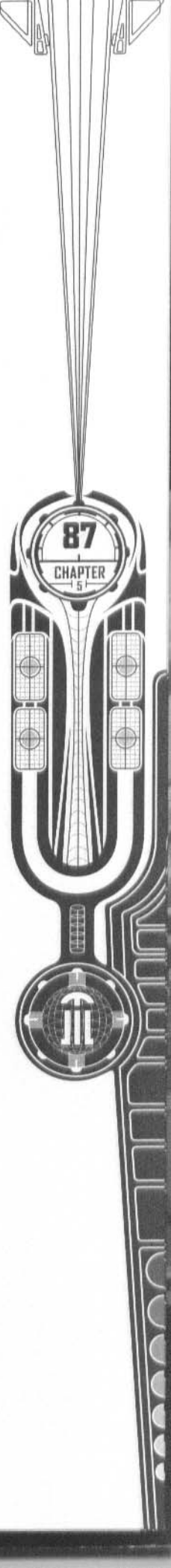

range of sound) of whatever is within it—usually a full-body image of the person using the pod to communicate.

A Hologram Projection Pod can also be used to search for specific information that may be available somewhere on the HoloNet. It functions just like a computer, but because it was not designed for this function it imposes a -5 penalty on Computer Use checks made with it.

#### SoroSuub Hush-98

**Cost:** 4,000  
**Availability:** Rare

**Weight:** 0.5 kg  
**Era:** ⚙️ ⚙️ ⚙️

The Hush-98 is one of the most expensive comlinks on the open market. In addition to an extended 100 km, low orbit communication range and encryption technology (requiring a computer and a Computer Use check DC 30 to decrypt if intercepted), the Hush-98 has silence projectors built into it. These create a tiny field of white noise around the comlink and whoever holds it, making it very difficult to overhear what is said into the unit (-5 penalty on all Listen checks to overhear) or sounds coming out of it (-10 on Listen checks).

#### SoroSuub Imagecaster

**Cost:** 1,000  
**Availability:** Common

**Weight:** 0.5 kg  
**Era:** ⚙️ ⚙️

The Imagecaster is a state-of-the-art personal holoprojector. Although it does not include a data transceiver and cannot transmit or receive images by itself, it can be connected to almost any other transmission or data source, including comlinks, droids, holorecorders, and larger holoprojectors. It can display an image up to 30 centimeters across and store up to 100 minutes' worth of images. If two comlinks, each connected to an Imagecaster, are in communication, they can send and receive real-time images, allowing for face-to-face communication. A single standard energy cell powers an Imagecaster for up to 24 hours of use.

#### Tramora Interstellar Communications VDV-100 Holo Display

**Cost:** 800  
**Availability:** Common

**Weight:** 1 kg  
**Era:** ⚙️ ⚙️

The VDV-100 is a holographically enabled comlink, able to receive and send holographic images. The VDV-100 is even able to receive (though not send) HoloNet transmissions. It can be set to automatically display the sender of a message prior to acknowledging it, block transmissions from certain sources, record short messages, and display an away-message.

A unique feature is the VDV-100's ability to match a recorded holographic image with the sender's live audio. When this feature is used, the sender's visual image is replaced by a recorded hologram of him (or another person), which moves to match the sender's speech. Originally marketed as a feature for users who have to take calls early in the morning before they look their best, criminals and others have used it to mislead people about their identities. A Spot check (DC 16) allows the person at the other end to notice that the holographic image does not exactly match the spoken message.

#### Traxes BioElectronics Implant Communicator

**Cost:** 12,500  
**Availability:** Common, illegal

**Weight:** 0.1 kg  
**Era:** ⚙️ ⚙️

The implant communicator is a marvel of modern electronics; it walks the narrow line between a conventional item that is simply well concealed and a true cybernetic device. It is a series of tiny transceivers that are placed under the skin against the skull and next to the vocal cords (or similar anatomy for non-Human recipients). These transceivers pick up subvocalized words and transmit them via a built-in comlink.

The implant communicator has a very short range (1 km) and is vulnerable to ion attacks (any successful ion or electricity attack against a target with the implants automatically destroys them). It is an excellent way to send and receive clandestine messages. It is very difficult to notice someone using an implant communicator (requiring a Spot check opposed by the target's Sleight of Hand check, with a +10 circumstance bonus on the Sleight of Hand check).

#### Ulqib MicroTronics BX-333 Biorecorder

**Cost:** 5,000  
(50 per additional holocube)

**Weight:** 1.5 kg

**Availability:** Rare

**Era:** ⚙️ ⚙️

**Special:** This item uses holocube storage devices (cost 50).

At first glance the BX-333 looks like little more than a holorecorder. In fact, the Biorecorder is a far more sophisticated device that measures the heart rate, blood pressure, and other vital signs of anyone recording a message with it. As a result, such messages are far more detailed, able to convey far more of the emotion and passion of the user's messages. It has been said that a message from a Biorecorder is just like seeing a person live. While a holocube can store 200 hours of normal holorecordings, it holds only 20 minutes of a Biorecorder holorecording.

The Biorecorder negates any penalties due to communications difficulties that might otherwise apply to Charisma-based skills.

#### Varge Corp Pocket Scrambler PS-xqt9s

**Cost:** 400  
**Availability:** Common

**Weight:** 0.5 kg  
**Era:** ⚙️ ⚙️ ⚙️

The PS-xqt9s is a simple add-on device that can be attached to any normal communications device, such as a comlink or holotransceiver. The pocket scrambler automatically encodes any message sent out, so that it can only be read by a communication device equipped with a linked pocket scrambler. Anyone who intercepts the message must make a Computer Use check (DC 30) to decrypt the scrambled message.

#### Whappamanga AlienEnhancer Voxbox

**Cost:** 75  
**Availability:** Common

**Weight:** 0.5 kg  
**Era:** ⚙️ ⚙️ ⚙️

The AlienEnhancer is a simple audio playback unit with twelve preprogrammed basic phrases ("Yes," "No," "Greetings," "When?," "Where?," "How much?," "Please take me to someone with authority," "I understand," "I need medical attention," "I mean no harm," "I'm sorry," and "I don't speak Basic"), each with its own button. These devices are useful for species who understand Basic but can't speak it (such as



Gamorreans and Wookiees). Devices built for languages other than Basic exist, but are less common (availability specialized).

## Detection Devices

Detection devices are generally of two types: specialized tools for finding specific information, often under special or unusual conditions; and broadband scanners that can detect a wide variety of subjects but only provide the most basic information about them. A high-end chemical detector, for example, is a specialized tool capable of detecting trace amounts of specific toxins in a small area. At the other extreme, a general-purpose scanner detects life forms, movement, and com signals over a large area, but might not be able to provide detailed data on any of them.

To locate something with a detection device may require a Computer Use check (if the device operates as a readout-style sensor) or a Spot or Search check (if the device enhances normal senses, such as a set of macrobinoculars). The base DC for most checks is 20, though many are opposed by the target's Hide check (when locating creatures or objects that are hiding or have been hidden) or Computer Use check (when detecting an opponent's monitored or encrypted communications or sensor signals).

Any detection device that provides an equipment bonus on Listen, Search, or Spot checks may be available in a mastercrafted version granting an additional +1 to the bonus, at double the normal cost. Skilled tech specialists who have special expertise with sensor packs may provide even larger equipment bonuses, though these devices are not normally available for sale.

### Courier Communications Scanner

**Cost:** 4,500  
**Availability:** Rare

**Weight:** 1 kg  
**Era:** ⚙️ ⚡️ ⚙️

A communications scanner is a receiver that can intercept, but not transmit, most forms of broadcast communications. The Courier Communications Scanner also has a built-in decrypting computer for translating coded messages. It provides a +5 equipment bonus on all Computer Use checks to find a particular transmission or decode a message.

### ChandrilTech PX-7 Heat Sensor

**Cost:** 250  
**Availability:** Common

**Weight:** 0.25 kg  
**Era:** ⚙️ ⚡️ ⚙️

The PX-7 is a simple handheld heat-detection unit with a display screen. It can locate heat sources within 100 meters, displaying their intensity with colored readouts. Using a PX-7 provides a +1 equipment bonus on Search and Spot checks made to perceive something that is a different temperature from its background (which includes almost all living creatures and most machines).

### Cryoncorp EnhanceScan General Purpose Scanner

**Cost:** 2,000  
**Availability:** Common

**Weight:** 8 kg  
**Era:** ⚡️ ⚙️

The EnhanceScan is an improvement over older, bulkier scanners that often required their own repulso-carts to be transported. It is a rectangular case the size of a large belt pouch, with many dials and controls on the front and two

extending antennae on its top. It is generally carried by a shoulder strap.

Similar to a ship's sensors, though far less powerful, it is able to scan to a range of 1,500 meters (though more than 1 meter of rock or metal blocks it). It can detect movement (and be set to give off an alarm when detected), find life forms, and monitor (though not broadcast) comlink signals. The EnhanceScan can accept up to three hundred different signals programmed for automatic recognition (allowing it to identify a particular species, vehicle, or transmission from its scans). It can be linked to a datapad or droid for additional information, or to a comlink to broadcast its sensor findings to a remote location.

Scanning for life forms or com signals with an EnhanceScan requires a Computer Use check (DC 15). This check has a range penalty of -1 per 100 meters. The EnhanceScan can also be used to add a +2 equipment bonus on the user's Listen, Search, or Spot checks, and can make Spot or Listen checks on its own (usually set to an alarm) as if it had a +5 skill modifier.

### Dalabar Micro-Electronics SDS-632 Surveillance Detector

**Cost:** 450  
**Availability:** Common

**Weight:** 0.5 kg  
**Era:** ⚙️ ⚡️ ⚙️

The SDS-632 is a small scanner specifically tuned to frequencies used for data transmission. No bigger than a Human's palm, the SDS can monitor the immediate area for outgoing transmissions, allowing it to detect tracers, surveillance equipment, and hidden communications devices. The user must make a Computer Use check (DC 15) with a special range penalty of -5 per 2 meters. (Thus, transmissions and surveillance made from a distance are unlikely to be detected.) A successful check does not reveal the exact nature and location of a transmission, only its presence.

### Fabritech SE-Vigilant Automated Sensor Beacon

**Cost:** 3,000  
**Availability:** Common

**Weight:** 5 kg  
**Era:** ⚙️ ⚡️ ⚙️

The SE-Vigilant is an automated sensor beacon used to maintain a perimeter alarm and to monitor areas. It is a pole 1.4 meters long when collapsed and 3 meters long at full extension. An energy cell at the base runs the two sensor assemblies at the top. The beacon also has a built-in comlink with a 50-km range.

When activated, the SE-Vigilant continually scans the area within 250 meters of it, making Listen and Spot checks to notice any vehicles or creatures moving within its monitored area. (The Vigilant makes its checks as if it had a +7 Listen skill modifier and a +10 Spot skill modifier.) It can generally distinguish between vehicles and creatures, and between creatures of different sizes. It can be set to sound an alarm, or send an alert by comlink, when it detects a vehicle or a creature of a particular size (any Medium-size or larger creature, for example), or when it detects anything at all. It can also be continuously monitored, locally or remotely via the comlink, in which case it grants a +2 equipment bonus on Listen or Spot checks made by the person monitoring it. (To make Spot checks, the receiving comlink must be connected to a video display.)



### Idellian Arrays ILF-5000 Life Form Scanner

**Cost:** 2,900

**Availability:** Rare

**Weight:** 1 kg

**Era:** ⚙️ ⚙️

The ILF-5000 is a specially tuned scanner that locates and identifies life forms. Its user may make a Computer Use check (DC 10) to locate life forms nearby. This check has a special range penalty of -1 for every 10 meters. The ILF-5000 can store information on ten species at a time, and it automatically indicates if a detected lifeform is one of these ten. Changing the programming requires a Computer Use check (DC 10). If a detected life form is not one of these ten, only the size, distance, and direction of the life form is indicated.

### Neuro-Saav 9320/B Sensor Pack

**Cost:** 1,200

**Availability:** Common

**Weight:** 0.5 kg

**Era:** ⚙️ ⚙️

The 9320 sensor pack is a handheld sensor unit designed for portability rather than power. It allows the user to detect com signals, energy emissions, or life forms nearby with a special range penalty of -1 for every 2 meters. Because the 9320/B is a fairly weak sensor, it is not particularly easy to use: The Computer Use DC for unopposed checks is 20; for opposed checks, the target receives a +5 circumstance bonus on its check.

### Neuro-Saav ChemDetect

**Cost:** 1,500

**Availability:** Common

**Weight:** 0.5 kg

**Era:** ⚙️ ⚙️ ⚙️

The ChemDetect is a molecular analyzer that takes in local atmosphere and examines it for hazardous or poisonous chemicals. It allows the user to make a Computer Use check to find such materials within 2 meters of the ChemDetect. It can also be set to make such checks on its own (as if it had a Computer Use skill modifier of +8) and set off an alarm (audio or vibratory) if hazardous chemicals are detected.

The DC for detecting a common hazardous material is 15. For rare chemicals the DC is 20, and for unknown or unique chemicals it is 25. High wind conditions or the presence of numerous nonhazardous chemicals can each increase the DC by 5. If the chemical is known, its effects are displayed by the analyzer whenever it is detected.

### Neuro-Saav Holorecording Macrobinoculars

**Cost:** 1,500

**Availability:** Common

**Weight:** 0.7 kg

**Era:** ⚙️

Developed from early prototypes built by commandos within the Rebel Alliance, Neuro-Saav Holorecording Macrobinoculars are larger and heavier than typical macrobinoculars, but are also able to record high quality holographic images on discs. Each disc stores one hundred still holoimages (Holorecording Macrobinoculars cannot record moving images) and costs 10 credits.

Holorecording Macrobinoculars provide a +2 equipment bonus on all Spot checks made with them, grant the user low-light vision, and lessen the range penalty for Spot checks to -1 per 10 meters.

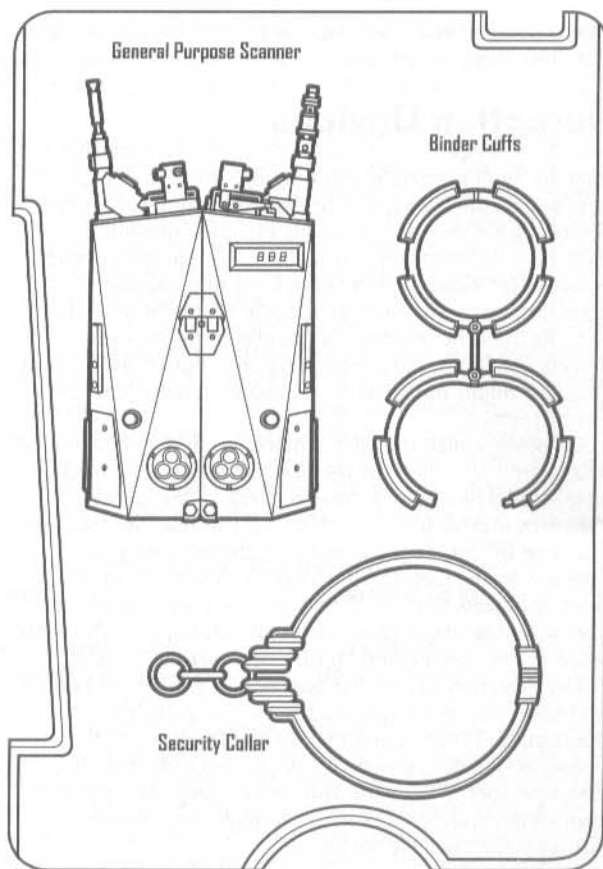

### Neuro-Saav TeleSonic Audio Pickup

**Cost:** 750

**Availability:** Prevalent

**Weight:** 1 kg

**Era:** ⚙️ ⚙️ ⚙️

The TeleSonic is a basic audio pickup device that can detect noises at long ranges, filter out background noise, and analyze common sounds. Sound can be recorded on a datacard, each card costing 10 credits and storing 3 hours of sound. The TeleSonic is the size of a small box 2 centimeters across and is often built into a helmet (costing an additional 50 credits).

Using a TeleSonic provides a +2 equipment bonus on all Listen checks and lessens range penalties for Listen checks to -1 per 10 meters.

### Rhinsome Tracking Corp SureSnoop

**Cost:** 3,000

**Availability:** Common, military

**Weight:** 1 kg

**Era:** ⚙️ ⚙️ ⚙️

**Special:** This item uses special tracking tags (cost 500).

The SureSnoop tracking system consists of a handheld scanner (similar to a standard sensor pack) and one or more tags. Each tag is a tiny transmitter, no more than 1 centimeter across, with a three-day battery. Tags are generally worked into small articles such as jewelry (perhaps given to the target as a gift), or slipped into a target vehicle. The tags are difficult to detect (Search check DC 35, or Computer Use check DC 30 with a scanner).

Used by itself, the SureSnoop can locate life forms, transmissions, and energy emissions, providing a +2 equip-

ment bonus on the user's Listen, Search, and Spot checks. However, the SureSnoop can also be used to find one of its tags, which requires a Computer Use check (DC 10, with a range penalty of -1 per 500 meters). On a successful check, the SureSnoop reveals the direction, distance, and speed of the tag.

#### **Saldalith Manufacturing Veridicator 200**

**Cost:** 4,000                      **Weight:** 0.1 kg  
**Availability:** Rare              **Era:** ⬇️ ⬆️

The Veridicator is a cunning sensor built to look like a bracelet or armband. It can scan a single target within 10 meters and read such basic information as heart rate, pupil dilation, and temperature. It then cross-references this information with an internal database to determine the likely emotional state of the target. (The Veridicator can be programmed for only one species at a time; reprogramming it requires a Computer Use check against DC 10.) The Veridicator transmits this information to its wearer through a set of simple pulses, providing a +2 equipment bonus on Sense Motive checks against the target.

#### **SuriTech Foodstuffs Ez1 Analyzer**

**Cost:** 250                         **Weight:** 0.5 kg  
**Availability:** Prevalent       **Era:** ⬇️ ⬆️

The Ez1 is a small, completely automated handheld scanner. It is designed to analyze food samples placed on its sample plate, to determine if they are safe for its programmed species to consume. It can be programmed for any species, but can hold only one species' data at a time. (Reprogramming the Ez1 requires a Computer Use check against DC 10.)

The Ez1 makes a Computer Use check as though it had a skill modifier of +8. Determining if food is poisonous for its programmed species is DC 10, determining if it is diseased is DC 20, and determining if it is nutritious is DC 25.

#### **VidGraph Peer Macrobinoculars**

**Cost:** 800                         **Weight:** 0.5 kg  
**Availability:** Rare              **Era:** ⚙️ ⬇️ ⬆️

Peer Macrobinoculars are also referred to as snooper goggles, because they are designed for use in twilight and darkness. Though their resolution is not as good as standard macrobinoculars, their nighttime uses generally outweigh that drawback.

Peer Macrobinoculars grant the user low-light vision and darkvision, as well as lessening the range penalty for Spot checks to -1 per 8 meters.

#### **Ziko 1125 Heads-Up Macrobinoculars**

**Cost:** 900                         **Weight:** 0.3 kg  
**Availability:** Prevalent       **Era:** ⚙️ ⬇️ ⬆️

The 1125 is a model of headset macrobinoculars designed to be worn rather than held in the hand. Like standard macrobinoculars, the 1125 gives information on range, azimuth, and elevation, and has a light-enhancing feature for twilight conditions. A character wearing this item is granted low-light vision and makes Spot checks with a range penalty of -1 per 10 meters.

## Sensor Jammers and Detection Countermeasures

As sensors became more advanced and increasingly common, new ways to fool them also began to be developed. Jammers are often a good way to increase stealth and maintain a low profile, especially if you know what kinds of sensors your opponent is using to find you.

#### **Audio Performance Inc. No-Show**

**Cost:** 5,000                      **Weight:** 0.1 kg  
**Availability:** Specialized, military   **Era:** ⬇️ ⬆️

The No-Show is a highly classified, carefully guarded piece of military hardware originally developed for the Rebel Alliance. It is a wrist-mounted unit that creates a skintight electromagnetic sheath, concealing a person's energy emissions (including body heat and sonic vibrations). This gives the user a +1 equipment bonus on Hide checks opposed by creatures, a +8 bonus on Hide checks opposed by sensors or creatures using sensors, and a +8 bonus on all Move Silently checks.

The sheath also interferes with any scanners held by the wearer of a No-Show, causing a -8 penalty on any Computer Use check to operate the scanner.

#### **Audio Performance Inc. Sheer Silence Bubble Generator**

**Cost:** 3,000                      **Weight:** 1 kg  
**Availability:** Common           **Era:** ⚙️ ⬇️ ⬆️

The Sheer Silence Bubble Generator creates a sphere of disruption 2 meters in diameter through which it is very difficult for sound to pass. The generator itself is a small box originally marketed to rich music-lovers as a "personal portable listening chamber," but it rapidly became popular with commando forces and criminals. Any Listen check made to hear a noise on the other side of the barrier takes a -10 penalty. It is difficult for those outside the bubble to hear what goes on inside, or those inside to hear external noises, but creatures within the bubble may converse normally.

#### **Corellidyne CQ-3.9x Holographic Image Disguiser**

**Cost:** 25,000                      **Weight:** 0.5 kg  
**Availability:** Rare              **Era:** ⚙️ ⬇️ ⬆️

A holographic disguiser is an advanced form of holoprojector capable of placing a stored holographic image over an existing real world object. Also called a holoshroud, this device allows items, including living creatures, to be almost perfectly disguised as other objects.

The CQ-3.9x is a small unit that can be worn on a belt and has only enough memory capacity to store a single holographic image. Obviously, the holo image must be at least as large as the item it is to cover. The CQ-3.9x has only enough power to operate for 2 minutes, though it is possible to hook it up to a larger power supply.

The image is extremely high in quality and even moves as the item or person shrouded moves, making it almost impossible for the unaided eye to detect as a fake (Spot check DC 25). Sensors, cameras, and droids are more likely to detect a telltale flicker and realize something is amiss; they receive a +5 bonus on their checks.

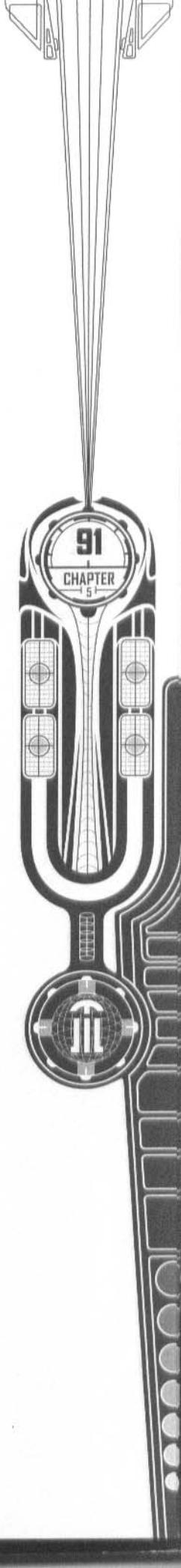

### Fabritech CN-15 Camouflage Netting

**Cost:** 3,500

**Availability:** Prevalent  
(👤 military)

**Weight:** 5 kg

**Era:** 🌐 🌐 🌐

More advanced than mundane camouflage, CN-15 netting is actually a metallic jammer net, connected to a small power source. The net is covered in overlapping sensor baffle scales that emulate the emissions pattern of surrounding terrain, including its light emissions. As a result, any Spot check attempted to identify an item hidden under CN-15 netting takes a -15 penalty.

The netting comes in a small backpack and takes 1 round for two people to fully deploy (a single person can deploy it in 2 minutes). It covers an area 15 meters by 15 meters.

### MicroThrust ComTech Eavesdrop Protection Unit

**Cost:** 3,400

**Availability:** Rare

**Weight:** 0.5 kg

**Era:** 🌐 🌐 🌐

The ComTech is a jammer pack, designed to foul all communications within 150 meters. Advertised as a way to ensure that secure conversations are kept private, it is actually most often used by commando units and criminals as a way to slow coordinated responses to their presence. When activated, the ComTech makes it difficult for any communications device within 150 meters to operate, requiring a Computer Use check (DC 30) for each transmission.

## Medical Equipment

When you're wounded in combat, nothing is as welcome a sight as a 2-1B medical droid. Sometimes, though—especially in the field—you have to make do with less advanced medicine, from medpacs to field cauterizers.

Medical equipment in and of itself does not restore more vitality points or wound points—it can only help when used with the Treat Injury skill. In some cases, equipment that allows a Treat Injury check may be used in situations when the user does not have the skill—the skill check is made as if the equipment itself had ranks in the skill. These ranks do not stack with the user's Treat Injury ranks, if any.

Medical equipment may be mastercrafted by a tech specialist. Mastercrafting increases the wound points restored by +1 for each mastercraft operation. Like most mastercrafted items, only the +1 version of any given medical device is readily available, and at a cost of double the normal price.

Many of the medical items covered here are advanced versions of medpacs, or include medpacs in their treatment. A character can only benefit from use of a single medpac in a 24-hour period—so a character treated by a medpac or medpac-using device cannot benefit from the use of another medpac or medpac-using device until 24 hours have transpired. For example, a hero treated with a medpac cannot then be further treated with an Athakam II Med Unit, because the Med Unit uses medpacs as part of its treatment.

### Athakam II Med Unit

**Cost:** 3,000

**Availability:** Common

**Weight:** 20 kg

**Era:** 🌐 🌐 🌐

A Med Unit is a 2-meter-long automated couch that is better than a medical kit but not as useful as a full

## WHAT'S IN MY MEDICAL KIT?

Medical kits are compact packages designed to equip a trained medic for work in the field and to allow untrained individuals to apply first aid in emergencies. The most important component of most medical kits is a basic scanner and medical computer, usually programmable for one species at a time. This provides critical information for doctors to use in advanced treatments, and gives basic instructions for laymen to apply the contents of the medical kit correctly. The scanner/computer unit is actually placed on the patient and automatically gives simple directions unless the user keys in a specific sequence that indicates he is a doctor.

The other items in a medical kit are usually held in straps that connect to either the scanner/computer or the kit's case. These almost always include a spray hypo with several medical vials, a laser cauterizer, a spray splint and bandage, a sonic scalpel, bone stabilizer compound, and a basic sample analyzer with a few sample vials. In the hands of an untrained user, only the spray hypo, splint, and stabilizer compound are generally required.

A medical kit does not typically contain a medpac, which is a specific, single-use treatment tool. ☹

medical droid. When a patient is placed within the Med Unit, it immediately begins to analyze the patient's condition, displaying any information it gains about wounds, diseases, and poisons the patient is suffering from. This takes 1 full round. The Med Unit then begins treating the patient with robotic arms and an internal supply of medical materials.

The Med Unit is designed to provide a minimal level of aid for any user, regardless of medical training. When activated, the Med Unit makes a Treat Injury check as though it were an individual with a medpac, a medical kit, and a +4 Treat Injury skill modifier.

A character with real medical skill can use the Med Unit to assist in her use of the Treat Injury skill. Make a Treat Injury check (DC 10) for the Med Unit; if successful, the unit provides the user a +2 bonus on the user's Treat Injury check, in addition to equipping him with a medpac and medical kit.

A Med Unit uses medpacs in its treatment of a patient. A character that has already been treated with a medpac within the past 24 hours does not gain the benefit of a medpac, but may benefit from other uses of the Treat Injury skill.

A Med Unit comes with enough materials for ten treatments requiring medpacs, after which the medpacs must be refilled (at the standard cost per medpac). A Med Unit may use mastercrafted medpacs as well as FastFlesh medpacs (see below), although these must be purchased separately.

### BioTech FastFlesh Medpac

**Cost:** 600

**Availability:** Common

**Weight:** 0.5 kg

**Era:** 🌐 🌐

The FastFlesh medpac is a more advanced, compact version of a standard medpac. It contains a broader array of chemicals and medical tools, giving a trained doctor more options for medical treatment. Like a standard medpac, it has only enough material and power for one use. Receiving treatment

from a FastFlesh medpac counts as a character's daily allowable medpac treatment.

The FastFlesh medpac grants all the benefits of a normal medpac, as well as a +4 equipment bonus on the Treat Injury check made when it is used.

#### BioTech RFX/K Medisensor

**Cost:** 1,100

**Availability:** Rare

**Weight:** 0.5 kg

**Era:** 

The RFX/K Medisensor is a small but powerful short-range sensor designed to assist medics. It is capable of reading various vital signs of a patient and displaying them, along with standard medical recommendations, onto a small viewscreen. The RFX/K is small enough to clip to a belt, and is often carried by military doctors.

The RFX/K provides a +4 equipment bonus on all Treat Injury checks made by its user.

#### Chiewab Amalgamated Pharmaceuticals Company

##### ECM-598 Medical Backpack

**Cost:** 600

**Availability:** Common

**Weight:** 5 kg

**Era:** 

The EMC-598 is designed as an all-purpose emergency medical kit. It includes a standard medical kit, a collapsible repulsorlift stretcher (capable of carrying up to 150 kg), a simple diagnostic scanner, and a medical procedures database. Consulting with the database (which takes a full-round action) provides a +2 equipment bonus on Treat Injury checks.

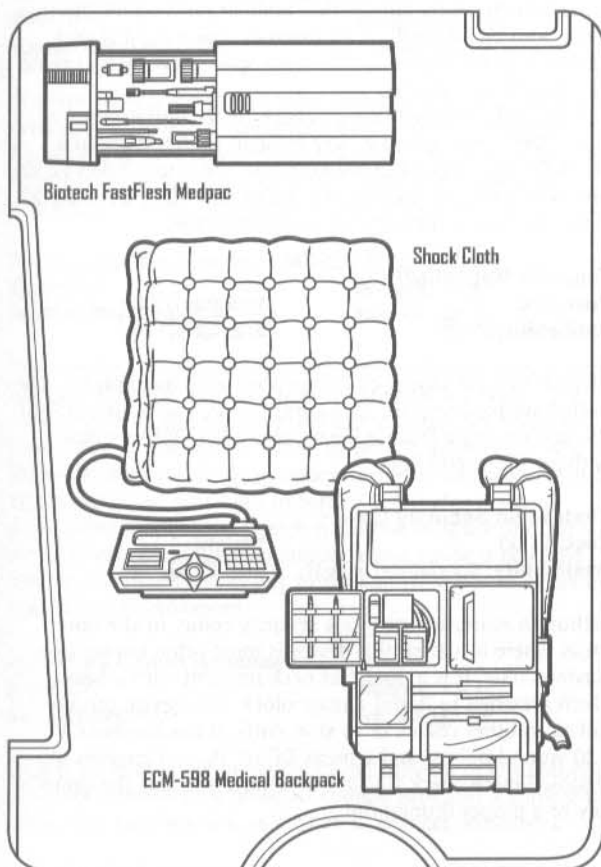

#### Fabreth Medical Biochemicals Shock Cloth

**Cost:** 250

**Availability:** Common

**Weight:** 1 kg

**Era:** 

One of the most important aspects of treating wounds is preventing shock. The Shock Cloth is a special temperature-controlled thermal blanket equipped with hundreds of tiny injectors and a small store of medical chemicals. When attached to a medical scanner, computer, or datapad (not included), it can administer medications as needed to specific parts of a patient's body while stabilizing body temperature.

The Shock Cloth provides a +5 equipment bonus on any Treat Injury check made to stabilize a character. This does not count as a use of a medpac. The Shock Cloth also grants +1 to Fortitude saves to resist cold weather. A Shock Cloth has enough chemicals for five treatments before it must be restocked (cost 50).

#### Nilar Med/Tech Corporation Field Caulterizer

**Cost:** 200

**Availability:** Prevalent

**Weight:** 0.1 kg

**Era:** 

The Field Caulterizer is a slender rod 16 centimeters long with a button at one end. When activated, it emits a low-frequency laser that disinfects and cauterizes wounds.

Using the Field Caulterizer as part of a Treat Injury check gives a patient a +3 bonus on any Fortitude saves made against diseases from the wound. The use must occur within 24 hours of sustaining the wound.

The cauterizer can also be used to help stabilize a dying character. Use of the cauterizer grants the patient a +3 equipment bonus on his Fortitude save to become stable. This function of the cauterizer can be used only once per dying character.

#### Synthtech Medtech Corporation MDS-50

**Cost:** 75

**Availability:** Prevalent

**Weight:** 0.1 kg

**Era:** 

The MDS-50 is a small, weak handheld sensor programmed to read the medical statistics of an individual over which it is passed, providing a quick readout of the patient's vital statistics. A character with an MDS-50 receives a +1 equipment bonus on Treat Injury checks to treat disease and poison, and may give himself long-term care.

## Security Devices

As technology advances, the ways to keep things secure—things such as information, valuables, and prisoners—has advanced with it. But for every new “unbreakable” code that is developed, a new deciphering computer is introduced a month later that can crack it. It is no longer a matter of trying to make things completely secure—that's obviously impossible. The best that can be hoped for is “secure enough,” making it too timely and costly to bother gaining access to a secured item. In most cases, security devices such as those described here are combined with monitoring equipment and security personnel or droids.

### Ealewon Electronics DCD-4800 Cryptographic Coder

**Cost:** 2,000

**Availability:** Prevalent

**Weight:** 5 kg

**Era:** ⚙️ ⚡️ ⚙️

The DCD-4800 Cryptographic Coder is a datapad with a built-in security program. It's larger and heavier than a typical datapad, but information stored in it is much more secure. It provides the user with a +2 equipment bonus on Intelligence checks relating to calculations or Computer Use checks involving information downloads. If loaded with a datacard containing specific information, it provides a +2 equipment bonus on related Knowledge checks. The DCD-4800 uses a standard datacard.

Most important, anyone attempting to access information from the DCD-4800 without a proper authorization code must make a Computer Use check (DC 35) to gain access.

### Locris Syndicated Securities MLC-50 Magnolock

**Cost:** 250

**Availability:** Prevalent

**Weight:** 1 kg

**Era:** ⚙️ ⚡️ ⚙️

A magnolock is a two-part system about the size of a datapad, designed to firmly secure an opening of any kind. When the two halves of a magnolock are placed on the door or lid of an opening (a hatch, chest, or doorway), they attach to it and each other with strength rivaling that of a molecular bond. The magnolock itself has hardness 10, 10 wound points, and a break DC of 40. (The hardness, wound points, and break DC of the door or hatch secured with a magnolock varies according to its composition.)

Deactivating a magnolock without the proper passkey requires a Disable Device check (DC 38) and takes 2d4 rounds.

### Locris Syndicated Securities SC-401 Stun Cuffs/Stun Cuff Remote

**Cost:** 100

**Availability:** Rare

**Special:** This item can be used with a special remote control (cost 500, weight 1 kg).

**Weight:** 5 kg

**Era:** ⚙️ ⚡️ ⚙️

Law enforcement officers and bounty hunters alike commonly employ Locris Syndicated Securities SC-401 stun cuffs to restrain prisoners. They are designed to fit over the wrists of any creature with arms (or something physiologically similar). Stun cuffs include a power pack and sensors, designed to tighten the cuffs' grip if anyone tries to slip out of them. The wearer can attempt an Escape Artist check (DC 40) to slip free of stun cuffs. If the check fails by 5 or more, the stun cuffs tighten enough to cause physical pain (and deal 1d4 points of damage). Stun cuffs have hardness 10, 10 wound points, and a break DC of 30—and again, failing a break check by 5 or more causes the cuffs to tighten, dealing 1d4 points of damage.

The tightening feature can be deactivated with a Disable Device check (DC 20), but if the check fails by 10 or more, the cuffs tighten (again dealing 1d4 points of damage). Deciphering the seven-digit master code requires a Computer Use check (DC 28); if that check fails by 10 or more, the cuffs tighten, dealing 1d4 points of damage.

The restraints can be controlled by a remote control that locks and unlocks them. (The remote has a range of 50 meters and can control up to twenty different sets of cuffs.) In addition to controlling the locking mechanism, the remote control can also be used to deliver a subduing jolt to the wearer. This shock is similar in effect to that of a stun baton: The wearer must succeed at a Fortitude save (DC 15) or be stunned for 1d4 rounds. If the remote is keyed to multiple sets of stun cuffs, selecting which wearers are affected requires a move action.

### Merr-Sonn Binder Cuffs

**Cost:** 50

**Availability:** Prevalent

**Weight:** 0.5 kg

**Era:** ⚙️ ⚡️ ⚙️

Binder cuffs are durasteel restraints designed to lock two limbs of a prisoner together. Normally the wrists or ankles are bound, but it is possible to lock one arm to one leg or use the binder cuffs to hook a prisoner to a stationary object, such as a tree limb or a railing. The cuffs have hardness 10, 10 wound points, a break DC of 30, and require a Disable Device check (DC 25) to remove without the seven-digit release code. Binder cuffs can be attached to the limbs of any Large or smaller creature.

### Navaplex Monofilament Screen Guard

**Cost:** 250

**Availability:** Common, restricted

**Weight:** 2 kg

**Era:** ⚙️ ⚡️ ⚙️

For truly excellent perimeter protection, few measures are as effective as a monofilament screen guard. Each guard is an 80-centimeter-long strip with a built-in power pack (though it can also be attached to an external power supply) and hundreds of cutting monofilaments spaced evenly and rising to a height of 2 meters.

If properly installed (Repair check DC 20 and 6 hours of work), the screen guard is very difficult to detect (Search check DC 25). A creature walking into the screen takes 2d10 points of damage. A successful Reflex save (DC 18, or DC 23 if the creature is running) halves the damage.

### TaggeCo MagnaCuffs

**Cost:** 600

**Availability:** Rare

**Weight:** 0.5 kg

**Era:** ⚙️ ⚡️ ⚙️

MagnaCuffs are binder cuffs equipped with magnolocks. The cuffs have hardness 10, 20 wound points, and a break DC of 35, and require a Disable Device check (DC 30) to remove without the circuit key.

### Thalassian Security Collar

**Cost:** 1,000

**Availability:** Specialized, illegal

**Weight:** 1 kg

**Era:** ⚙️ ⚡️ ⚙️

Although manufactured as a security collar, in the rare areas where it is legal this device is most often known as a slaving collar. It is a durasteel neck restraint with a heavy chain attached to it and a magnolock. The device can be linked to other collars or to stun cuffs. It has hardness 10, 120 wound points, and a break DC of 35, and requires a Disable Device check (DC 35) to remove without the circuit key or a proper thumbprint.

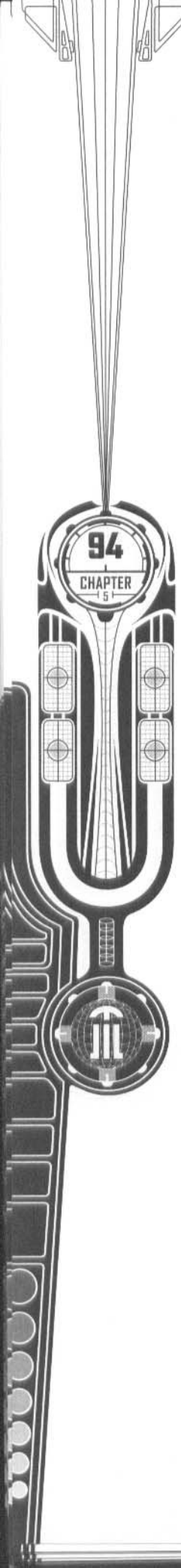

If the collar takes any damage, or if a Disable Device check fails by more than 5, the collar delivers an extremely painful neural shock. This shock deals 1d4 points of damage and knocks the victim out for 2d6 rounds (Fort save DC 15 halves the damage and time). Most security collars come with a remote trigger and can also be programmed to accept verbal cues to trigger from particular voices.

## Survival Gear

Whether you're sightseeing in the mountains of Tatooine or crash-landed in the swamps of Dagobah, you need the right equipment to survive. The most important considerations are food, water, shelter, and a way to signal for help. While many of these items can be found or constructed in most types of terrain, in some places a lack of proper equipment leads to a quick death.

### Adventure Hiker & Hunter DuraShelter

**Cost:** 500 **Weight:** 0.5 kg  
**Availability:** Prevalent **Era:** ⚙️ ⚡️ ⚙️

A DuraShelter is a collapsible one-person tent covered in a di-crome finish and lined in thermal insulation. It is carried in a pack no bigger than a datapad. When deployed, the di-crome finish emulates the colors of its surroundings, providing the user with a +2 equipment bonus on Hide checks. The DuraShelter also grants anyone within it a +5 equipment bonus on Fortitude checks made to resist severe weather.

### Adventure Hiker & Hunter Ration Packs

**Cost:** 5 **Weight:** 0.1 kg  
**Availability:** Prevalent **Era:** ⚙️ ⚡️ ⚙️

A ration pack is a compact meal that takes up little room (you can fit six in a pouch designed to carry a datapad) but has all the requirements to nourish a person for one day. The food isn't appetizing, and the pack doesn't include water, but it does prevent starvation.

### Meradex Atmospheric EMS-90 Bubble Cloak

**Cost:** 800 **Weight:** 1 kg  
**Availability:** Prevalent **Era:** ⚙️ ⚡️ ⚙️

The harshest possible environment for most creatures is the vacuum of space. The only hope of survival is a self-contained unit, but escape pods and vac suits are bulky to carry around. The Bubble Cloak solves this problem. It is a thick but fashionable cloak under normal circumstances, but can fan out and seal itself to form a 1.2-meter-diameter survival bubble, tough enough to survive in space and carrying a 2-hour air and power supply. While inside a powered bubble, a character does not suffer any effects from extreme cold in the environment.

### Mos Espa Coolth Backpack

**Cost:** 200 **Weight:** 1.5 kg  
**Availability:** Rare **Era:** ⚙️ ⚡️ ⚙️

Coolth backpacks are generally found only on desert planets. The pack consists of a powered cooling unit and a sunshield fabric that can function as a cloak or blanket. Wearing a

## WHAT'S IN MY ESCAPE POD?

Escape pods are designed for emergency situations only, when leaving a starship seems like a better idea than staying. As a result, they tend to have a minimal amount of equipment, since whatever is stored in the pod is considered a wasted resource by most business accountants. On the other hand, everyone realizes that if you need an escape pod, you'll probably need some survival tools as well.

A typical escape pod has enough food and water to nourish one person for eight days. Galactic law requires it to have a medical kit and at least one medpac, but a surprising number don't. An emergency homing beacon and comlink set at least as powerful as a OmniNode Communications Set (described earlier in this chapter) is generally built in, and can be removed without too much difficulty (Repair check DC 10).

More extensively equipped escape pods, such as those found on the pleasure ships of the very wealthy and in the command sections of some military starcraft, are likely to include a weapons locker (with 1d4 blaster pistols), a set of breathing devices (likely similar to the Roamer-6 breath mask (described earlier in this chapter), a medical kit, 1d4 medpacs, and some form of survival gear (usually a field kit).

Coolth backpack keeps a character comfortable in high temperatures, providing a +4 equipment bonus on Fortitude saves to resist great heat.

### Saladar Systems PED-21 Distress Beacon

**Cost:** 200 **Weight:** 2 kg  
**Availability:** Common **Era:** ⚙️ ⚡️ ⚙️

The PED-21 is an emergency distress beacon. It works as a hyperspace-capable transmitter, sending a signal on standard emergency frequencies at a long enough range to cover an entire system and any nearby hyperspace lanes. It broadcasts the emergency signal only, and cannot receive signals. Once a ship detects the beacon's signal, it's a simple matter to use the ship's sensors to locate it (Computer Use check DC 15). It has a battery sufficient for ten years of continuous operation.

### SurvivalGear Water JugFilter

**Cost:** 100 **Weight:** 0.5 kg  
**Availability:** Prevalent **Era:** ⚙️ ⚡️ ⚙️

The Water JugFilter is a 1-liter water canteen with an internal filter capable of decontaminating water. This process takes as little as a few minutes for lightly contaminated water to several hours for extremely tainted water. Poisons, toxins, diseases, and microbes are all removed. Once the decontamination process is complete, a small light on the canteen's cap glows green.

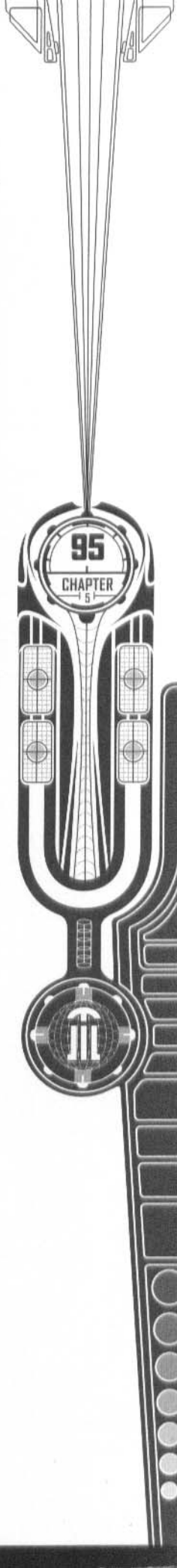

## Tools and Other Sundries

Any object designed to make a task easier—or take care of it entirely—is essentially a tool. Most technical jobs can be performed with a security kit or tool kit, but some devices not included in those packages don't fit under any other category, and are presented here.

**Alliwan Electronics Vennoc-x Chronometer**  
**Cost:** 50 **Weight:** 0.1 kg  
**Availability:** Prevalent **Era:** ☼ ☾ ☽

The Vennoc-x is an excellent chronometer, able to tell time on a thousand different worlds, as well as being programmable to hold data about new worlds. (Reprogramming it requires a Computer Use check against DC 10.) It has a timed alarm that can be set to audio or vibratory. It also has a hidden compartment 4 centimeters square, able to conceal a single credit or circuit chip (Search DC 35 to find the compartment).

**BlasTech Blaster Repair Kit**  
**Type:** Repair kit/tools **Cost:** 125 **Weight:** 2 kg  
**Hardness:** 2 **WP:** 2 **Break DC:** 14  
**Availability:** Prevalent **Era:** ☼ ☾ ☽

This handy kit provides most of the small tools necessary for the upkeep, repair, and customization of blaster pistols and rifles. The tools include a pulse adapter module tester, a collimator beam fuser, a prismatic crystal aligner, static pulse adapter modules, an energy converter valve, multiple gas valve nozzles, a spare gas container, a spare trigger cable, and a variable pressure adjuster. A full kit has enough space left over to hold three spare power packs.

Having a repair kit counts as proper tools for Repair checks to fix blaster weapons.

**Degan Explorations Syntherope**  
**Cost:** 5 (per 20 m length) **Weight:** 0.5 kg  
**Availability:** Prevalent **Era:** ☼ ☾ ☽

Syntherope is a high-friction corded material used for climbing. Because it is easy to hold on to, it provides a +2 equipment bonus on Climb checks made while using it. It often comes with an automated winch (cost 120, 2 kg), able to lift up to 200 kg. The rope has DR 0, 2 wound points, and a break DC of 23.

**Greel Wood Logging Corporation TreeFelling Vibrosaw**  
**Cost:** 400 **Weight:** 10 kg  
**Availability:** Common **Era:** ☼ ☾ ☽

Designed to cut down large vegetation, a vibrosaw is essentially a specialized vibro-ax. A user taking a full-round action to attack a stationary object with a vibrosaw deals 2d8 points of damage and can ignore 5 points of the object's hardness. Vibrosaws are sometimes used to cut bulkheads in boarding actions, and are often kept as weapons in areas where true vibro weapons are illegal. A vibrosaw used as a vibro weapon deals 2d8 points of slashing damage. It is a Large weapon, and proficiency requires the Exotic Weapon Proficiency (vibrosaw) feat.

A vibrosaw requires two energy cells to operate.



### WHAT'S IN MY TOOL KIT?

The standard tool kit (see Chapter Seven of the *Star Wars Roleplaying Game*) represents a broad collection of tools designed to take apart, analyze, modify, and rebuild almost any technological device. Most technicians personalize their tool kits over the course of years, but almost all contain at least a fusion cutter and vibro-cutter, hydrospanner, laser welder and sonic welder, power calibrator (for analyzing circuitry and to act as an emergency power cell), power prybar, probe sensors, various circuits and connector wires, and welding goggles.

Many of these tools can be used as makeshift weapons. They all qualify as simple weapons, but since they aren't designed for combat they impose a -1 penalty on attack rolls. Droids with such tools built in don't take these penalties, since they don't have to deal with an oddly shaped handle. The damage done by these tools is fusion cutter 2d4, laser welder 1d4, power prybar 1d6, and sonic welder 2d4. ☼

**Interstellar Droid Monitoring Inc. Mk-II Droid Diagnostic**  
**Cost:** 200 **Weight:** 2 kg  
**Availability:** Prevalent **Era:** ☼ ☾ ☽

The Mk-II Droid Diagnostic is a handheld computer unit and scanner about twice the size of a datapad. It is designed to analyze the functions of a droid it is plugged into, displaying data on a screen and listing possible causes of problems. A droid diagnostic provides a +2 equipment bonus on Repair checks and Disable Device checks made on the droid to which it is connected.

Similar diagnostics exist for blasters, repulsorlifts, computers, and starships.

**MicroData Pocket Secretary**  
**Cost:** 2,000 **Weight:** 0.5 kg  
**Availability:** Prevalent **Era:** ☼ ☾ ☽

The Pocket Secretary is a combined datapad and audio recording unit with administrative software built in. It provides the user with a +2 equipment bonus on Intelligence checks relating to calculations, Computer Use checks involving information downloads, and Profession (administrator) checks. If loaded with datacards containing specific information it provides a +2 equipment bonus on related Knowledge checks. It can record up to 12 hours of audio on a datacard. Its administrative programming can function independently, keeping track of its owner's schedule, ordering supplies as needed, and automating payroll.

A mastercraft Pocket Secretary is double the normal cost and provides a +3 equipment bonus instead of +2. Some tech specialists can produce even more effective units.



# HOKEY RELIGIONS AND ANCIENT WEAPONS ARE NO MATCH FOR HAVING A GOOD BLASTER AT YOUR SIDE.

To use this sourcebook, you also need the *Star Wars Roleplaying Game Revised Core Rulebook*.

The galaxy is a dangerous place, and even the most capable heroes need the right equipment to get the job done. Outfitting for a rescue mission on a frigid ice planet differs from gearing up for an assault on a crime lord's jungle world headquarters. But with the right connections, and enough credits, heroes can acquire all the weapons and tools needed to survive any situation.

## This sourcebook features:

- An arsenal of weapons and armor, along with rules for customizing and personalizing them.
- A wide variety of droids from across the galaxy, including the legendary R-Series astromech droids, binary load lifters, and the RA-7 "Death Star" droid. ©11v 2003.04.10
- An array of vehicles from landspeeders to military walkers.
- Essential survival equipment, including breathers, comlinks, scanners, medpacs, and tools.

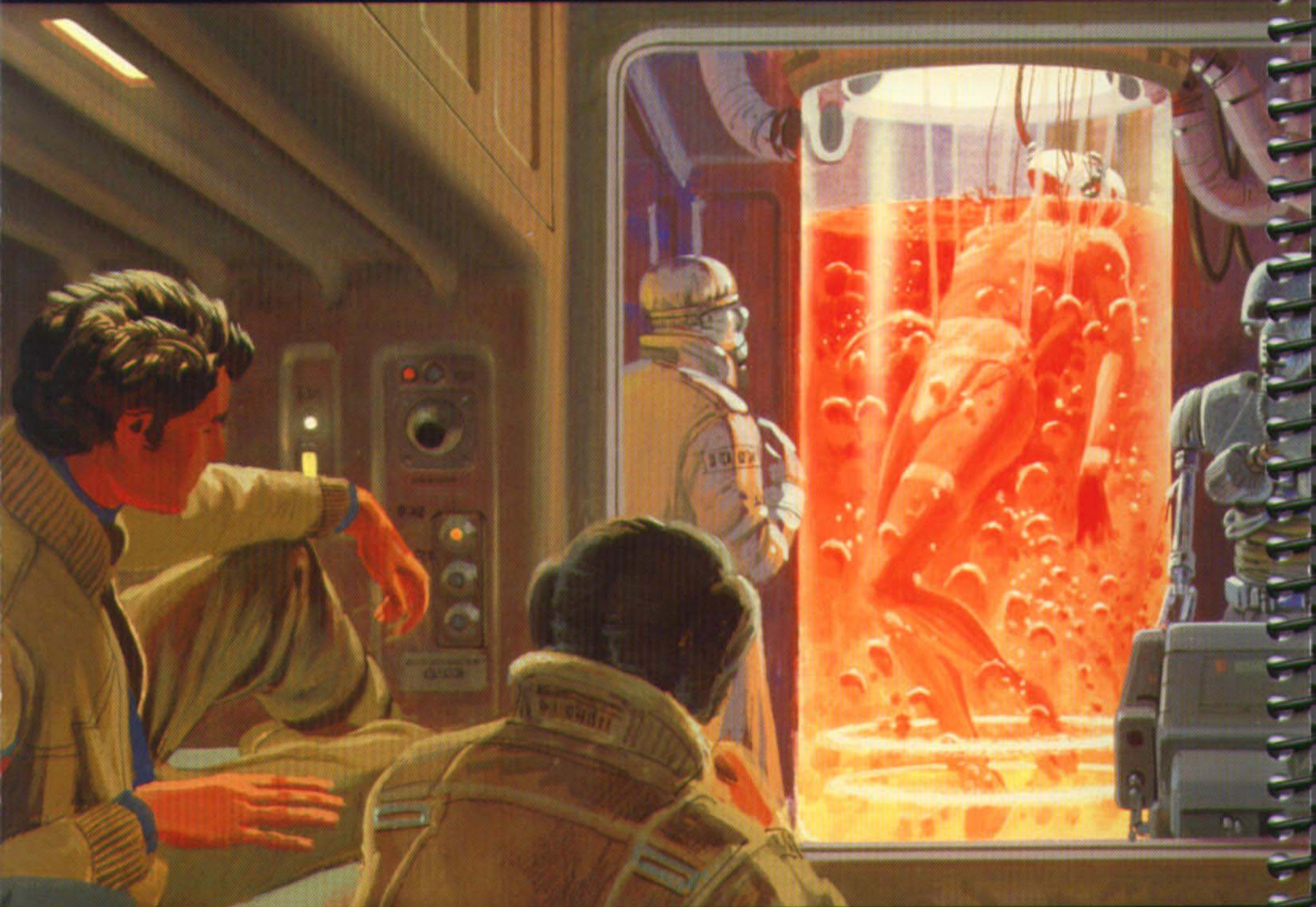

www.wizards.com

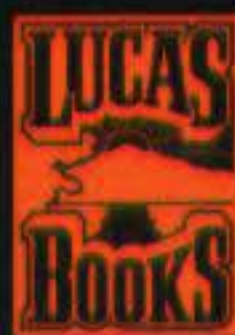

www.starwars.com



ISBN 0-7869-2782-8



U.S. \$21.95 CAN \$32.95  
Made in the U.S.A. 886640000



THIS PRODUCT FOR USE WITH ALL STAR WARS ERAS

SOURCE BOOK

© 2002 Lucasfilm Ltd. & or ™ where indicated. All rights reserved. Used under authorization.